

FILM-TECH

THE INFORMATION CONTAINED IN THIS ADOBE ACROBAT PDF FILE IS PROVIDED AT YOUR OWN RISK AND GOOD JUDGMENT.

THESE MANUALS ARE DESIGNED TO FACILITATE THE EXCHANGE OF INFORMATION RELATED TO CINEMA PROJECTION AND FILM HANDLING, WITH NO WARRANTIES NOR OBLIGATIONS FROM THE AUTHORS, FOR QUALIFIED FIELD SERVICE ENGINEERS.

IF YOU ARE NOT A QUALIFIED TECHNICIAN, PLEASE MAKE NO ADJUSTMENTS TO ANYTHING YOU MAY READ ABOUT IN THESE ADOBE MANUAL DOWNLOADS.

WWW.FILM-TECH.COM

Bell & Howell

— for all your movie needs

8mm and

16mm cameras

and projectors

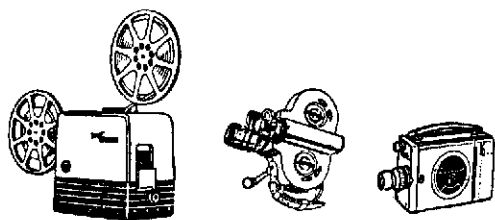
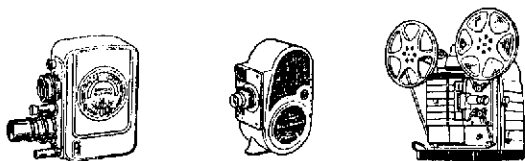

accessories for your

camera and projector

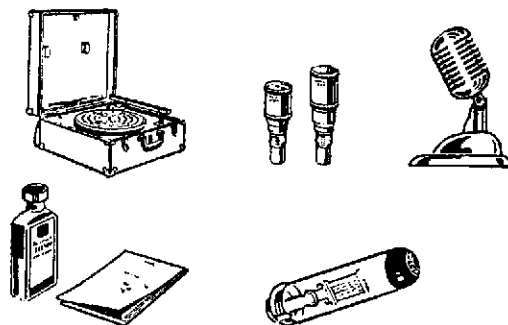

**You Buy the Best When You Buy Bell & Howell
Visit Your Bell & Howell Dealer Today**

Precision-made by

Bell & Howell Company

CHICAGO

NEW YORK

HOLLYWOOD

How to use your **BELL & HOWELL** Filmosound 285 16mm sound-film projector

IMPORTANT

The Bell & Howell Lifetime Guarantee is VOID unless you register the serial number of your equipment with Bell & Howell. Use the stamped self-addressed reply card over this cover. Registration of your equipment brings you the following advantages:

1. Obtaining the full benefits of the B&H Lifetime Guarantee.
2. Assistance in finding your equipment in case of loss or theft.
3. Free correspondence counsel from our Personal Service Department.
4. Receipt of bulletins about movie equipment and its use.

Use the stamped registration card over booklet cover to register your equipment with Bell & Howell—mail it today! The serial number of your Filmosound will be found beneath the snubber roller, as illustrated below.

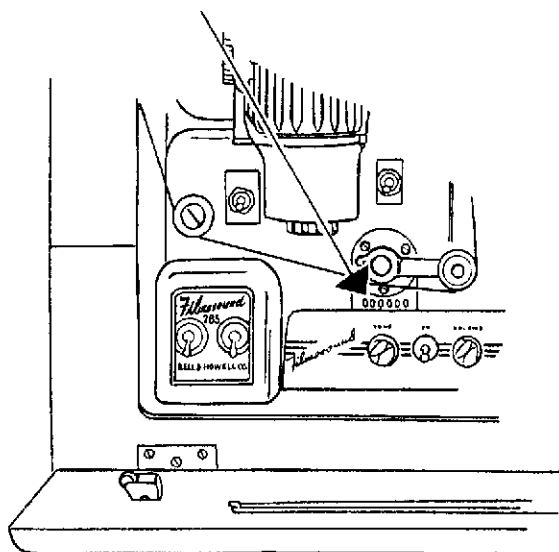

Congratulations!

You have purchased a promise with your Filmosound—a Bell & Howell promise of professional “movies” with amateur ease for years to come.

Behind this promise and your Filmosound stand years of Bell & Howell research, tireless craftsmanship of engineers and workmen, and the finest materials made. To be sure you get the perfect pictures your Bell & Howell equipment is made to give, study the following pages carefully with your Filmosound in front of you. Then, when you put it to work, you'll get matchless performance from your very first try.

We designed your Filmosound with an eye to technical improvements yet to come. So that you will never lose your original investment, we gave it a far-sighted basic design—a built-in capacity to keep pace with modern developments. Later, to make your Filmosound as up-to-date as the newest one on your dealer's shelf, you simply incorporate the improvements in your sturdy Filmosound.

The sharp, steady pictures you get—in full, natural color or sparkling black-and-white—are proof of Bell & Howell superiority. Matched film movement mechanisms of B&H cameras and projectors and precision manufacturing from start to finished product give you perfect results—over a long lifetime.

Please feel free to call on your Bell & Howell dealer or write directly to us for further information. We promise to stand behind our products—your purchases—through the years to come.

BELL & HOWELL COMPANY
7100 McCormick Road
Chicago 45, Illinois

Bell & Howell *Guarantee*

1. This product is guaranteed against defects in materials and workmanship. During its lifetime, any servicing necessary because of imperfections in materials or workmanship will be done without charge (except for transportation of equipment) by Bell & Howell Company or any company-approved service station.
2. Equipment which has been damaged or abused, or worn from extended use will be repaired at factory established rates.
3. Bell & Howell lenses purchased with this equipment are covered by this guarantee. Lenses of other makes, projection lamps, and film are not covered by this guarantee.
4. No liability is assumed for film which is damaged or is unsatisfactory for any reason (due to equipment malfunction or otherwise) nor is Bell & Howell obligated to replace such film.
5. No liability is assumed for expenses or damages resulting from interruptions in operation of equipment.
6. This guarantee is void: (a) if adaptations or accessories of other than Bell & Howell recommendations have been made or attached; (b) if equipment has not been registered with Bell & Howell (use card supplied with equipment); (c) if equipment has been serviced by other than a Bell & Howell approved service station.
7. This guarantee is made in lieu of any other guarantee, warranty or liability, express or implied. It is valid only as to the initial purchaser of this new equipment, his donees or his bona fide vendees, upon receipt by Bell & Howell of a registration card or letter giving the name and address of the present owner of the equipment.

Bell & Howell Company

W. H. Taylor
President

10 ACTIONS . . . of setup and operation

4 MINUTES . . . of pre-show time

for PICTURES OF PERFECTION



... Make electrical connections

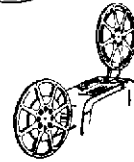

... Attach reel arms



... Set sound-silent switch



... Thread film



... Turn on amplifier



... Start film-moving mechanism

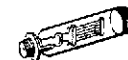

... Turn on lamp



... Focus lens

VOLUME



... Adjust volume

TONE



... and tone

Contents

	PAGE
Setting Up	5-8
Positioning of Projection Units.....	5
Electrical Connections—Speaker	6
Electrical Connections—Projector	6
Preparing to Operate	7-8
Threading the Film	9-12
Table of Projected Picture Sizes.....	11
Operation	12-17
Projecting Sound Film	12
Projecting Silent Film	13
Still Picture Projection	14
Reversing	14
Rewinding	14
Microphone	15
Phonograph Turntables or Transcription Players.....	15
Operation on 115-volt Direct Current.....	15
Operation on 220-volt, 25-cycle or 50- to 60-cycle Alternating Current	16
Public Address System	16
Projection Problems and Remedies.....	17-21
Maintenance	22-28
Projection Lamp Replacement	22
Cleaning Optical and Film Handling Parts.....	22
Projector Lubrication	24
Spring Belt Replacement	24
Fabric Take-up Belt Replacement.....	25
Exciter Lamp Replacement	25
Tube Replacement	25
Fuse Replacement	27
Pilot Light Replacement	27
Removing the Projector from the Case.....	27
Speaker Cord Maintenance	28
Instructions for Models 285-B and -B1.....	28-29
Instructions for Model 285-B2.....	29-36
Special Instructions for Filmosound Equipped with Cordomatic Speaker Cord Reel	36

How to use your BELL & HOWELL FILMOSOUND Model 285-C

The information given in the following pages refers *specifically* to the Filmosound Model 285-C and *generally* to the Filmosound Models 285-B, -B1 and -B2. Differences in operation of the Models 285-B, -B1 and -B2 are given on pages 28 through 36.

Setting Up

Positioning of Projection Units. Place the Filmosound at the rear of the room on a stand or table of a height which will permit projecting over the heads of the audience. Set up the projection screen, at the front of the room, according to the instructions accompanying the model to be used.

Open the upper door of the projector case, and then the lower door. The feed reel arm HR and take-up reel arm JS are transported as shown in Figure 1; the 400' take-up reel I travels on the lower door. Remove cord, reel arms, and all necessary accessories from their carrying positions in case.

The speaker is mounted on a door built into the far side of the projector case. It may be used in any one of three positions, as desired: within the case, in the position in which it travels; at a 90° angle to the case, by pulling the speaker door outward until it snaps into place at this angle; at the screen, by opening the speaker door and lifting it off the split hinges on which it is hung. See Figures 2, 3 and 4.

When the speaker is used at the screen, place the speaker as nearly as possible at the center of the screen and above the floor, but not so high as to interfere with the picture. Lo-

Figure 1
HR Feed reel arm
I Take-up reel
JS Take-up reel arm

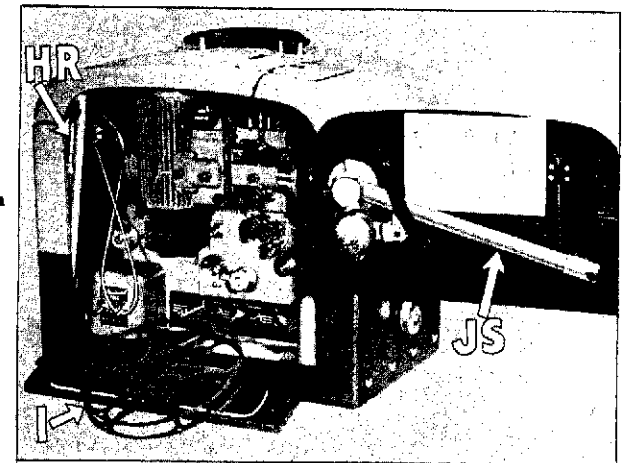

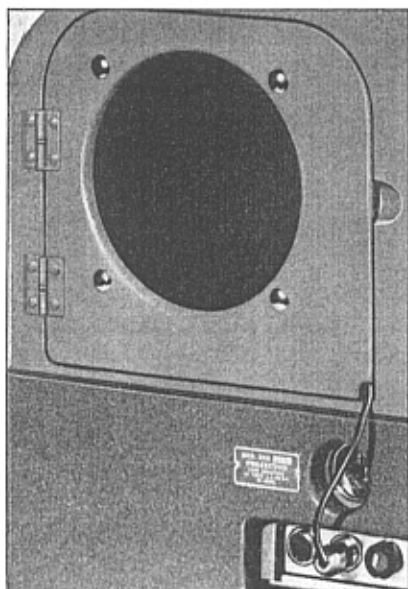

Figure 2
Speaker used within case

cate the speaker at least 18 inches in front of any obstructing surface.

Electrical Connections — Speaker. With the speaker positioned as desired, uncoil the necessary length of speaker cable from the storage brackets ML, Figure 3, on the rear of the speaker; the storage brackets serve as a stand for the speaker when it is used apart from the projector case. Connect plug MP, Figure 5, of speaker cable to 8-ohms receptacle R, Figure 5.

To use one or two 3" or 12" speakers with the Filmosound 285-C, follow the speaker instructions on page 28. To use one or more power speakers, follow the instructions on page 30-31. If desired, the built-in 6" speaker may serve as a monitor speaker when the 3", 12" or power speaker is used.

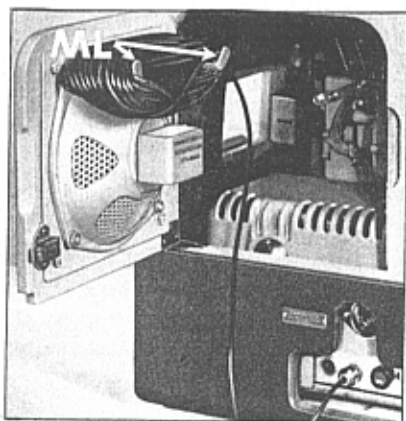

Figure 3
Speaker used at 90° angle to case
ML Storage brackets

When show is over, remove plug MP from receptacle R and wind speaker cable evenly over brackets ML, Figure 3.

Electrical Connections — Projector. When speaker has been set up and connected, with all controls on the Filmosound in the OFF position, insert plug FP, Figure 5, into projector receptacle PR, Figure 5. Plug other end of cord into a wall or extension

Figure 4
Speaker removed from case

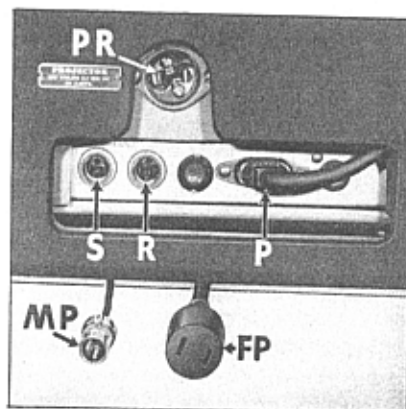
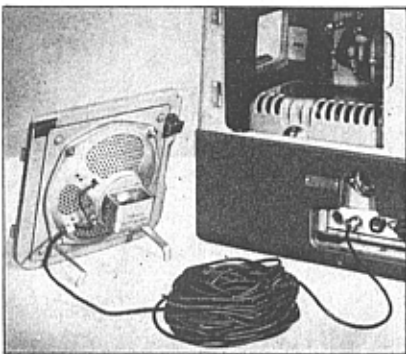

Figure 5
FP Female plug
MP Male plug
P Amplifier receptacle
R 8-ohms receptacle
S 16-ohms receptacle
PR Projector receptacle

cord receptacle supplying 105- to 130-volt 25-cycle or 50- to 60-cycle alternating current.

Since the Filmosound draws 11 amperes, it should be connected to a line fused at 15 amperes or more. If other appliances are connected on the same line and the total current drawn by appliances and Filmosound exceeds the rating of the fuse in that line, either connect Filmosound to another source, transfer some appliances to another line, or disconnect them while Filmosound is in use.

Preparing to Operate. Insert feed reel arm HR, Figure 6, in socket at top front of projector case, with spindle turned to operator's side of projector; press down in socket until notches in end of arm fit over locking pin in socket. Insert take-up reel arm JS, Figure 6, in socket at upper rear of projector case, with spindle turned to

operator's side of projector; press down in socket until notches in end of arm fit over locking pin in socket. Reel arms cannot then be turned in sockets.

Loop the front spring belt, without a twist, over the feed reel arm pulley at the top of feed reel arm HR, Figure 6, on the side opposite the spindle. Loop rear spring belt, without a twist, from drive pulley RP, Figure 6, to take-up pulley Q, Figure 7.

Remove the projection lamp as instructed in the paragraph on "Projection Lamp Replacement" and check its voltage; if voltage of lamp does not match that of voltage to be used, replace the lamp with another of the correct voltage.

When silent film is to be projected, the use of a 750-watt lamp is recommended, as the additional illumination provided by the 1000-watt lamp is not then necessary.

Set direction switch DS, Figure 8, at FORWARD; set sound-silent switch SS, Figure 8, at SOUND. If silent

Figure 6
HR Feed reel arm
JS Take-up reel arm
RP Take-up drive pulley

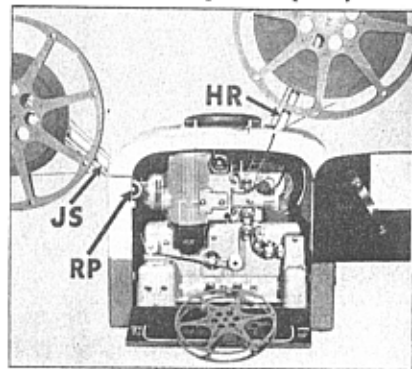

film is to be projected, see paragraph on "Projecting Silent Film," page 13.

Open the small door in the case in front of the projection lens. Turn on projector switch PS, Figure 8, and lamp switch LS, Figure 8; turn clutch control X, Figure 8, to the extreme clockwise position. If the projector electrical connections have been correctly made, the film moving mechanism should now operate and a beam of light be projected on the screen.

Move the projector on its stand or table to such a position that the projected beam coincides with the screen. Tilt the projector up, if necessary, by turning tilt adjustment knob TN, Figure 8, in a clockwise direction.

If the projected image is larger than the screen, move the projector closer.

If the image is too small, move the projector farther from the screen.

If room size limits the throw, select the correct lens as indicated in the table of projected picture sizes on page 11.

With the projector operating and the lamp turned on, loosen lens locking screw LL, Figure 8, and slide the lens L, Figure 8, forward or backward in its carrier until the outlines

of the aperture or frame are sharply defined. To further sharpen focus, revolve the lens first in one direction and then in the other. When the point of maximum sharpness is found, tighten lens locking screw LL, Figure 8, securely.

Place projector switch PS, Figure 8, in the OFF position. Set amplifier switch G, Figure 8, at ON. Allow about one minute for the tubes to heat; then, move volume control V, Figure 8, in a clockwise direction until a hiss is heard in the speaker. At the same time a light should be seen from behind exciter lamp cover Z, Figure 8. If these conditions exist, electrical connections and other adjustments have been made correctly and the Filmosound is ready for threading.

Figure 8

- DS Direction switch
- G Amplifier switch
- L Lens
- LL Lens locking screw
- LS Lamp switch
- M Microphone jack
- PL Pilot Light
- PS Projector switch
- SS Sound-silent switch
- T Tone control
- TN Tilt adjustment knob
- V Volume control
- X Clutch control
- Z Exciter lamp compartment cover

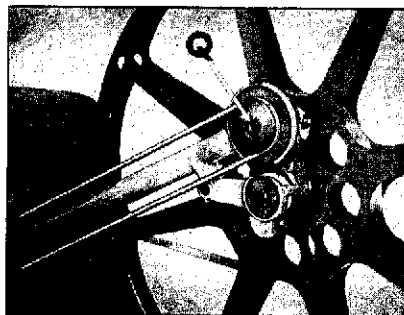
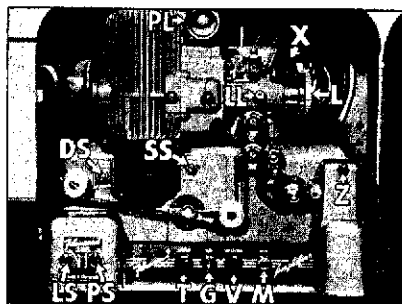

Figure 7
Q Take-up pulley



Threading the Film

With all controls in the OFF position and clutch control X, Figure 8, turned to the extreme counter-clockwise position, place the first reel, or a practice reel, of film on the spindle of feed reel arm HR, Figure 6, and an empty reel on the spindle of take-up reel arm JS, Figure 6. Press each reel firmly on the spindle until the small retaining spring-balls lock the reels in position on the spindles. Pull off about four feet of leader film for threading.

The film, if correctly wound, should feed from the front of the reel with the perforated edge toward the operator and the emulsion (dull) side out. (Exception: Duplicates from original reversal film, prints of 16mm negatives and Kodachrome films are wound and projected with emulsion side in.) Slip the film into the slot at the base

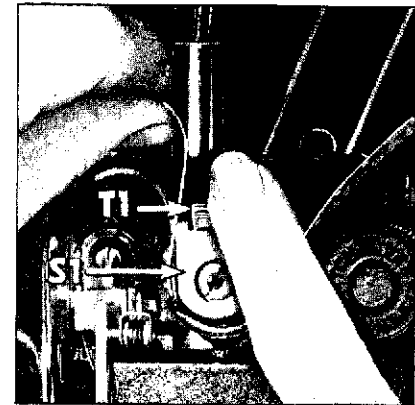

Figure 9
S1 Sprocket
T1 Sprocket tab

of feed reel arm HR, Figure 6, and between the two guide rollers. Lead the film over roller and below sprocket S1, Figure 9. Slide the film as far toward the machine as it will go. Holding the film snugly around the sprocket, press on tab T1, Figure 9, to open the guard. Pull gently on the film until the perforations seat over the sprocket teeth. Then release tab T1, locking the film on the sprocket.

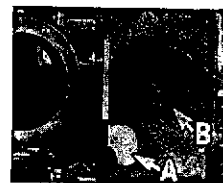

Figure 10
A Gate lever
B Hand setting knob

Swing film gate lever A, Figure 10, upward to open the film gate. Form the first loop, following the outline on the side of the gear case, as shown in Figure 11. Pass the film through the channel behind the lens as in Figure 11, being certain that it is fully seated in this channel. Then close the film gate by pressing down film gate lever A, Figure 10, as far as it will go. Form the second loop, conforming to the outline on the gear case, and slip the film over sprocket S2. Figure 12. Slide the film as far toward the machine as it will go. Holding the

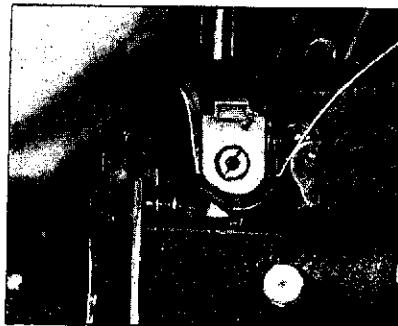

Figure 11

film snugly around the sprocket, press on tab T2, Figure 12, to open the guard. Pull gently on the film until the perforations seat over the sprocket teeth. Then release tab T2, locking the film on the sprocket. Turn clutch control X, Figure 8, to the extreme counter-clockwise position; then, turn hand setting knob B, Figure 10, several clockwise revolutions to engage the film with the shuttle teeth. Should the lower loop slide upward, open the gate and reset the loop to the outline on the gear case. Close the gate, and test the threading again by using the hand setting knob. Turn clutch control X, Figure 8, to the extreme clockwise position.

Lead the film from under sprocket S2, Figure 12, under roller R1, Figure 13, around sound drum SD, Figure 13, under roller R2, Figure 13, and over sprocket S3, Figure 14. Press the film as far toward the projector as it will go, over the sprocket. Pull down gently on the film as it passes over the sprocket until the



Figure 14
S3 Sprocket
T3 Sprocket tab

Oscillatory Stabilizer OS, Figure 13, is moved to its extreme position by the tension on the film. Then, open the sprocket guard by pressing on tab T3, Figure 14. Free the film just sufficiently to permit the Oscillatory Stabilizer to pull it back to the first available set of perforations, and release tab T3 to lock film on sprocket. Pass the film under snubber SN and rear idler roller K, Figure 15, into the slot at the base of the take-up reel

Figure 12
S2 Sprocket
T2 Sprocket tab

Figure 13
OS Oscillatory Stabilizer
R1 Stabilizer roller
R2 Stabilizer roller
SD Sound drum

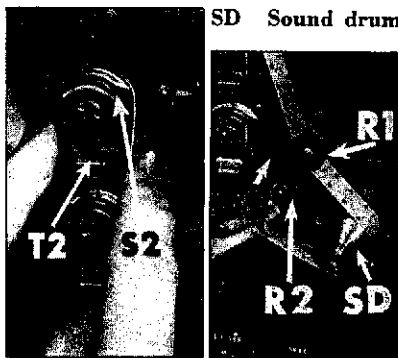

Figure 15
K Rear idler roller
SN Snubber



arm, and between the two guide rollers. Place the film around the bottom of the take-up reel I, Figure 16, and revolve reel to remove film slack.

No special precautions need be observed to synchronize the sound to the picture since adherence to the foregoing instructions will assure correct synchronization.

The mechanism on the take-up reel arm is a combination take-up and rewind device. Set it for take-up by pressing lever U, Figure 17, while the reel is on the spindle. No adjustment or compensation is necessary for various reel sizes, since the flat fabric belt between pulleys Q and Q1, Figure 17, provides complete and automatic compensation without any adjustments.

Figure 16
I Take-up reel

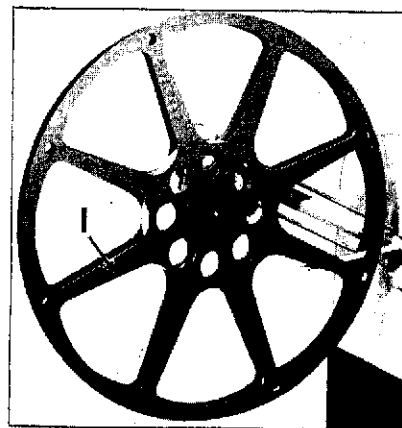
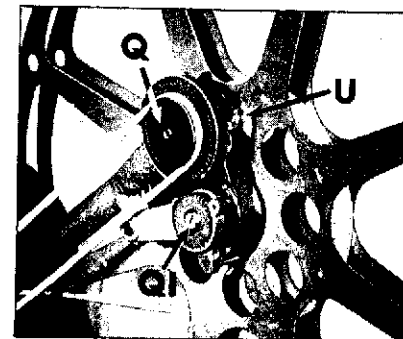

Figure 17
Q Take-up pulley
Q1 Spindle pulley
U Take-up lock lever



Projected Picture Sizes Obtained with B&H Projection Lenses

LENS FOCAL LENGTH	DISTANCE IN FEET FROM SCREEN TO FILM																
	8'	10'	12'	15'	20'	25'	30'	35'	40'	45'	50'	60'	75'	100'	125'	150'	
16mm Projector	WIDTH AND HEIGHT OF PICTURE																
	Upper Dimension is Width of Picture																
0.64"	4'9"	5'11"	7'2"	9'0"	12'0"												
0.75"	3'11"	4'11"	5'11"	7'6"	9'11"	12'6"											
	2'11"	3'8"	4'5"	5'7"	7'5"	9'3"											
1"	2'11"	3'8"	4'5"	5'7"	7'5"	9'4"	11'3"	13'1"									
	2'2"	2'9"	3'4"	4'2"	5'7"	6'11"	8'4"	9'9"									
1.5"	1'11"	2'5"	2'11"	3'8"	4'11"	6'2"	7'6"	8'9"	10'0"	11'3"	12'6"						
	1'5"	1'10"	2'2"	2'9"	3'8"	4'7"	5'7"	6'6"	7'5"	8'4"	9'4"						
2"	1'10"	2'2"	2'9"	3'8"	4'8"	5'7"	6'6"	7'5"	8'5"	9'4"	11'3"	14'0"	18'9"	23'5"	28'2"	
	1'4"	1'8"	2'1"	2'9"	3'5"	4'2"	4'10"	5'7"	6'3"	6'11"	8'4"	10'5"	13'11"	17'6"	21'0"	
2.5"	1'5"	1'9"	2'2"	2'11"	3'8"	4'5"	5'3"	6'11"	6'8"	7'5"	9'0"	11'3"	15'0"	18'9"	22'6"	
	1'1"	1'3"	1'8"	2'2"	2'9"	3'4"	3'11"	4'5"	5'0"	5'7"	6'8"	8'4"	11'2"	13'11"	16'9"	
3"	3'1"	3'8"	4'4"	5'11"	5'7"	6'2"	7'5"	9'4"	12'6"	15'7"	18'9"	
	2'3"	2'9"	3'3"	3'8"	4'2"	4'7"	5'7"	6'11"	9'3"	11'7"	14'0"	
3.5"	2'7"	3'2"	3'8"	4'3"	4'9"	5'4"	6'5"	8'0"	10'8"	13'4"	16'1"	
	1'11"	2'4"	2'9"	3'2"	3'7"	3'11"	4'9"	5'11"	7'11"	9'11"	12'0"	
4"	2'3"	2'9"	3'3"	3'8"	4'2"	4'8"	5'7"	7'0"	9'4"	11'8"	14'0"	
	1'8"	2'1"	2'5"	2'9"	3'1"	3'5"	4'2"	5'2"	6'11"	8'8"	10'5"	

Before projecting, you must be able to answer "yes" to the following questions:

1. Have you read, and carefully followed, the preceding instructions?
2. Have you checked the aperture, removable gate shoe, and optical components to see if they need cleaning? (See pages 22-24.)
3. Are both film loops of the correct size?
4. Is the film properly engaged on sprockets S1, S2, and S3?
5. Is the film gate closed?
6. Is the film properly started on take-up reel I, with all film slack removed?
7. Is the take-up reel arm mechanism set to *take up* film?
8. Is direction switch DS set at FORWARD?
9. Is sound-silent switch SS set for the type of film, sound or silent, to be projected?
10. Is the power supplied to Filmosound and power speaker 105- to 130-volt, 25-cycle or 50- to 60-cycle alternating current? (Or have you correctly connected the converter for operation on direct current?)
11. Have you tested the threading by turning the hand setting knob B or by momentarily turning on the motor?
12. If projecting sound film, is amplifier switch G set at ON?
13. If using a microphone with silent film, is amplifier switch G set at ON?
14. Have you learned from the ensuing pages of this manual: How to use a microphone and turntable; how to use the still picture clutch and tone control; how to rewind film; how to operate the Filmosound in reverse?

(After you have become adept at threading the film through the mechanism, turn on amplifier before threading. The amplifier tubes will then warm up to the proper operating temperature, so that sound projection can be started as soon as threading is completed.)

Operation

Projecting Sound Film. With amplifier operating and the volume control V, Figure 18, about one-quarter on, turn off pilot light PL, Figure 8, by pushing cap back and place projector switch PS, Figure 18, in the ON position. Immediately after the motor has started, place lamp switch LS, Figure 18, in the ON position and turn clutch control X, Figure 19, to extreme clockwise position.



Figure 18

- G Amplifier switch
- LS Lamp switch
- M Microphone jack
- PS Projector switch
- T Tone control
- V Volume control

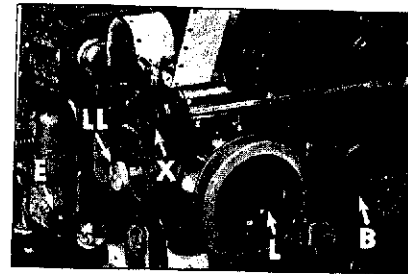

Figure 19

- B Hand setting knob
- E Framer control
- L Lens
- LL Lens locking screw
- X Clutch control

With the projector operating and the lamp on, loosen lens locking screw LL, Figure 19, and slide lens L, Figure 19, forward or backward in its carrier until the outlines of the aperture or frame are sharply defined. To further sharpen focus, revolve the lens first in one direction and then in the other until the point of maximum sharpness is found. Lock lens in position by turning lens locking screw LL, Figure 19, in a clockwise direction until tight.

If the picture frame line shows on the screen, turn framer knob E, Figure 19, to make the frame line disappear. If framing moves the picture off the screen, readjust tilt adjustment knob TN, Figure 8.

The volume control V, Figure 18, operates similarly to volume controls on radio sets. Advance or retard it as necessary to produce the desired volume of sound.

The tone control T, Figure 18, is also operated similarly to a tone control on a radio receiver. By means of this control, frequency range can be

compensated for in accordance with the acoustical conditions under which the equipment is being used. At each showing set it for the most desirable reproduction.

Project the first reel, or a practice reel, in its entirety. Run it over again, as necessary, until you are thoroughly familiar with every phase of operation and threading.

As "The End" title appears on the screen, place lamp switch LS, Figure 18, in the OFF position and, as the end of the narration or music is reached, retard volume control V, Figure 18, until no sound is heard. Run the remaining trailer of film completely through the machine.

Projecting Silent Film. To project silent film, thread the machine in the usual way. Set sound-silent switch SS, Figure 20, at SILENT. Do not turn on amplifier unless oral comments are to be made through the speaker by means of a microphone, or musical accompaniment is to be reproduced by means of a turntable. Turn off pilot light. Set projector and lamp switches and adjust focus and framing as for sound film.

If using a microphone, adjust volume control V, Figure 18, until the most pleasing sound volume is attained. If using a B&H turntable, adjust turn-

Figure 20

- DS Direction switch
- SS Sound-silent switch



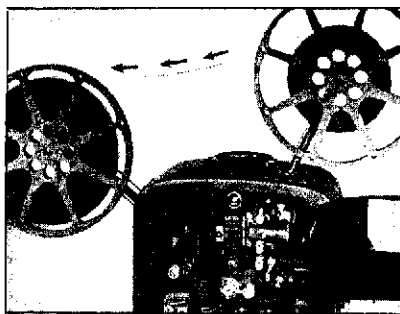

Figure 21

table volume control for best results under existing acoustical conditions.

Still Picture Projection. To project a single film frame as a still picture, turn clutch control knob X, Figure 19, one full counter-clockwise revolution, which disengages the projector mechanism. If no picture appears on the screen, the closed section of the shutter is obscuring the light. Turn hand setting knob B, Figure 19, slightly to bring the open section of the shutter into correct position. Adjust the lens to focus the still picture; re-focus when motion is resumed.

Reversing. Retard volume control V, Figure 18, until the sound is inaudible. Stop the film by disengaging clutch control knob X, Figure 19, or by placing projector switch PS, Figure 18, in the OFF position. When the mechanism has stopped, set direction switch DS, Figure 20, at REVERSE. The lamp may be on or off, as desired.

NOTE: Always stop projector mechanism before changing film direction.

Rewinding. Remove the take-up reel, which has now received the entire film, and the empty feed reel from their spindles and interchange the two reels. Lead the end of the film over the top

of the empty reel so that the film travel appears as in Figure 21. Press take-up lock lever U, Figure 17, and lift take-up reel as far as it will go to engage the rewind gears. Then, while still holding the reel in the lifted position, release pressure on lever U, to lock the assembly in rewind position. The take-up arm gears will then appear as in Figure 22.

Place direction switch DS, Figure 20, at FORWARD, place projector switch PS, Figure 18, in the ON position, disengage clutch control knob X, Figure 19, and allow the motor to run until all of the film has been rewound on the original reel.

Immediately after rewinding and before removing the loaded reel, press lever U, Figure 17, to restore the assembly to the take-up position.

When only a portion of a reel has been projected and must be rewound, unthread the projector and interchange the two reels. Then proceed with rewinding in the usual way.

NOTE: No twisting, changing or removing of any belt is necessary when rewinding or taking up film.

Figure 22

Gears on take-up arm locked in rewinding position

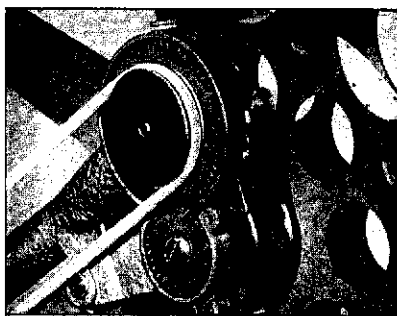

Microphone. A high-grade crystal or high-impedance dynamic microphone may be used with your Filmosound. Slip the end of the microphone cable beneath the projector case into the opening between case and amplifier base, so that both case doors may be closed if desired.

When using microphone with *silent* film, set sound-silent switch SS, Figure 20, at SILENT and insert microphone plug into jack M, Figure 18. Turn on Filmosound amplifier. Adjust the volume to the desired level by means of volume control. If there is a considerable lapse of time between broadcast comments, turn off the amplifier, to eliminate extraneous noises.

When commentary is over, turn off Filmosound amplifier and remove microphone plug from jack M.

When using microphone with *sound* film, before inserting plug into jack M, Figure 18, set sound-silent switch SS, Figure 20, at SILENT, to disconnect exciter lamp while microphone is in use. Adjust Filmosound volume control for best results under existing acoustical conditions.

While it is possible to connect the microphone without disconnecting the exciter lamp, it is not possible to adjust the microphone volume without correspondingly affecting the film sound volume, since both are adjusted through the same control. It is, therefore, advisable to use the microphone as instructed above.

When microphone is *not* in use, remove plug from jack M and set sound-silent switch SS at SOUND in order that sound from film may again be heard.

Phonograph Turntables or Transcrip-

tion Players. Any phonograph turntable with a sapphire stylus, crystal pick-up, or a high-impedance magnetic pick-up arm may be used with the Filmosound provided that it has an independent volume control.

When using phonograph turntable with silent film, with sound-silent switch SS, Figure 20, at SILENT and turntable volume control at minimum position, insert turntable plug into jack M, Figure 18. Set volume control V, Figure 18, at maximum position; set amplifier switch G, Figure 18, at ON and allow amplifier tubes to warm up. Then adjust turntable volume control for best results under existing acoustical conditions. When using phonograph turntable to provide background music for *sound* film, with turntable volume control set at minimum position, insert turntable plug into jack M. Adjust turntable volume control to desired sound level.

Operation on 115-volt Direct Current. If the amplifier is to be operated on direct current, a DC to AC converter having a capacity of 100 watts is necessary for the operation of the *amplifier* alone. The film-moving mechanism will operate on either alternating or direct current without any changes. When operating on DC, amplifier must be disconnected. The output of converter must be connected to amplifier receptacle.

Connect the converter to the direct current outlet with a line cord. Connect the female end of a second line cord to projector receptacle PR, Figure 5, and the male end to one socket of the direct current outlet. Plug the male end of the Filmosound cord into the AC output of the converter and the flat arm AP, Figure 5, into amplifier receptacle P, Figure 5.

ence of a large number of people will
 fer; be sure to replace shell properly
 Figure 32. Return amplifier to posi-
 tion in projector; reconnect exciter
 lamp lead wire plug and tighten am-
 plifier retaining screws securely. Re-
 turn speaker to projector case.

Projection Problems and Remedies

Problem

Kennedy

1. Filmosound will not operate.
 1. a. Check to see that current sup-
 ply cord is correctly connected
 to wall receptacle or extension
 cord outlet.
 - b. Test current outlet with ordi-
 nary lamp or other device known
 to be in working order to see
 if current is supplied to outlet.
2. Exciter lamp does not light and
 no sound is heard from speaker.
 - a. Check speaker cable connec-
 tions at speaker and Filmo-
 sound.
 - b. Check to see if projector ampli-
 fier switch is in the ON position.
 - c. Check to see if fuse in projec-
 tor amplifier is blown.
 - d. Check to see that sound-silent
 switch is set at SOUND.
 - e. Check to see that exciter lamp
 lead wire is connected.
 - f. Check to see if exciter lamp is
 burned out. If so, replace lamp.
 - g. Check to see that projector am-
 plifier tubes are correctly seated
 in correct sockets.
 - h. Replace projector amplifier
 tubes with a complete new set.

Figure 23
 Arrangement and
 connection of
 Filmosound unit
 for operation on
 115-volt DC

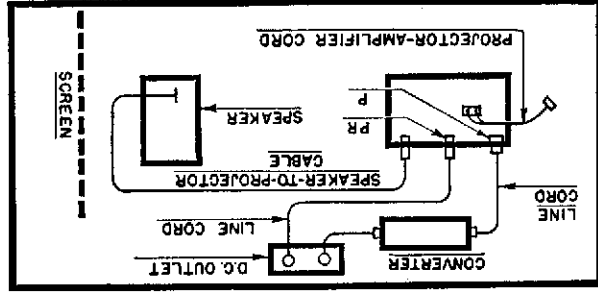

When correctly positioned and con-
 nected, the units will appear as in
 Figure 23. Operation is the same as
 for alternating current.

Operation on 220-volt, 25-cycle or
 50- to 60-cycle Alternating Current.
 When the Filmosound is to be oper-
 ated on 220-volt alternating current,
 a 1500-watt, 220- to 115-volt trans-
 former is required. Plug the 220-volt
 side of the transformer into the alter-
 nating current outlet. Connect the fe-
 male end (FP, Figure 5) of the pro-
 jector line cord to the projector as
 for normal operation (see "Electrical
 Connections—Projector"). Plug male
 end of line cord into 115-volt side of
 transformer. Operation is the same as
 for 115-volt alternating current.

Public Address System. To use the
 speaker and amplifier of your Filmo-
 sound, in conjunction with a micro-
 phone or turntable, as a public ad-
 dress system, remove the amplifier
 from the projector as instructed on
 page 26 under "Tube Replacement."
 Remove photocell PE, Figure 33, from
 the amplifier, following the procedur-
 e described under "Tube Replacement,"
 the program begins, since the pres-
 ented in advance of their use. It may
 be necessary at that time to adjust
 the tone control to eliminate tre-
 quency noises resulting from adverse
 acoustical conditions. Further slight
 adjustments of volume and tone con-
 trol settings may be necessary when
 the program begins, since the pres-

With either setup, it is recommended
 that the units be positioned and
 tested in advance of their use. It may
 be necessary at that time to adjust
 the tone control to eliminate tre-
 quency noises resulting from adverse
 acoustical conditions. Further slight
 adjustments of volume and tone con-
 trol settings may be necessary when
 the program begins, since the pres-
 ented in advance of their use. It may
 be necessary at that time to adjust
 the tone control to eliminate tre-
 quency noises resulting from adverse
 acoustical conditions. Further slight
 adjustments of volume and tone con-
 trol settings may be necessary when
 the program begins, since the pres-

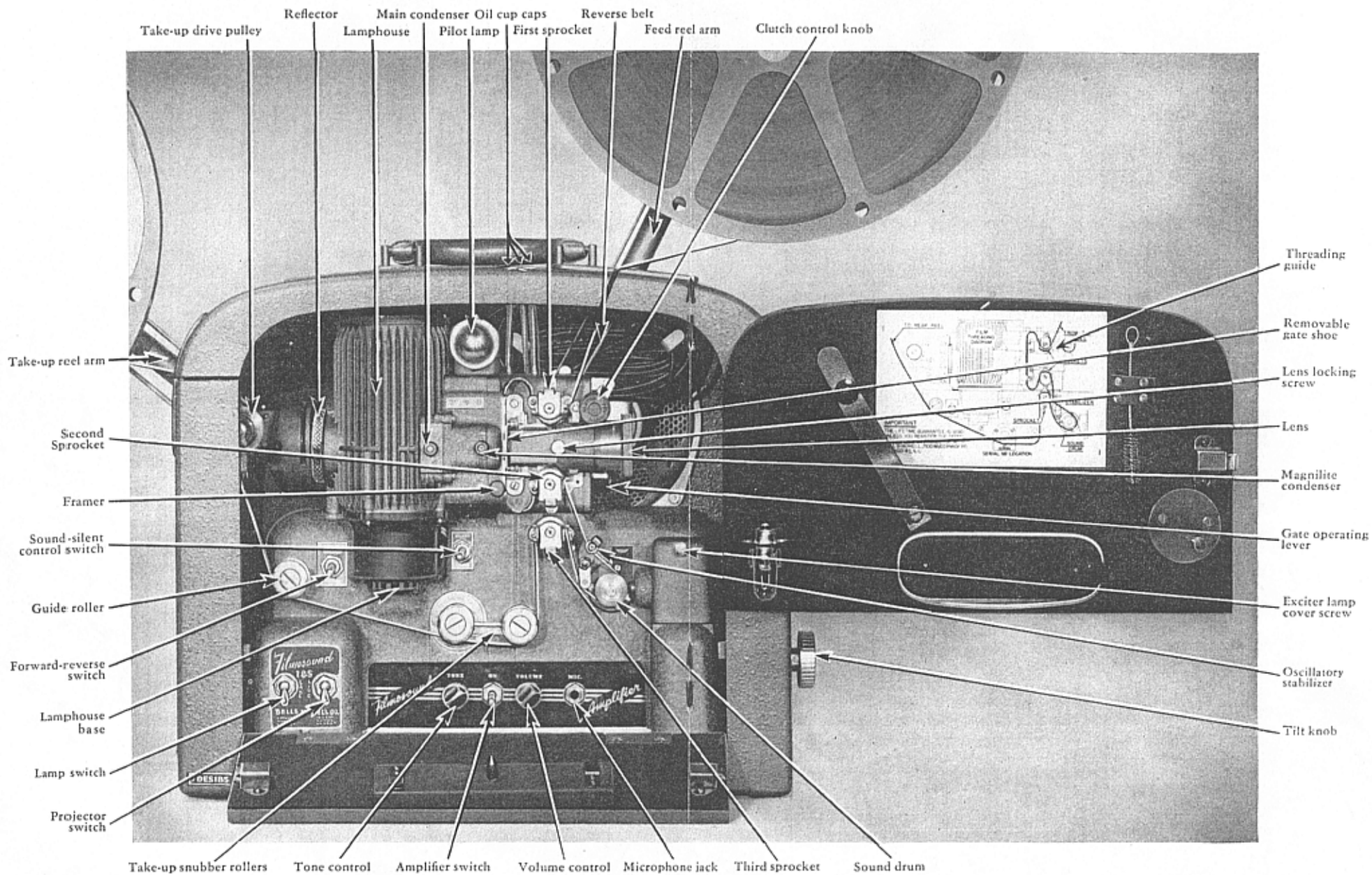

3. Exciter lamp lights but no sound is heard from speaker.
3. a. Advance volume control slightly.
 - b. Check film threading.
 - c. Clean lens and mirror of sound optical system to remove dirt.
 - d. Check position of exciter lamp light shield. Opening in shield may not be opposite optical slit.
 - e. Sound may be missing from film; to prove that defect lies in film and not with Filmosound, proceed as follows: Remove the film and turn on the amplifier. Turn volume control to maximum position. Pass a card swiftly back and forth between sound lens and sound drum. If a loud "thumping" noise is heard from the speaker, the Filmosound itself is operating properly and the sound is missing from the film.
 - f. Replace projector amplifier tubes with a complete new set.
 - g. Photocell shell not firmly screwed down.
4. Sound volume is not adequate.
4. a. Advance volume control toward maximum position.
 - b. Check to see that line current supplied to projector is of the correct voltage.
 - c. Check to see if film is clean. Dirty or poorly made film will not give the full sound volume.
 - d. Clean lens and mirror of sound optical system to remove any dirt or dust.
 - e. Check exciter lamp. If defective, replace; if incorrectly positioned, remove and replace correctly, wiping off dirt or fingerprints.
 - f. Replace amplifier tubes with complete new set.
5. Sound quality is unsatisfactory.
5. a. Check to see that sound-silent switch is set at SOUND.
 - b. Check to see that amplifier is firmly fastened in projector.
 - c. See other remedies given for defect No. 4 (see preceding page).
 - d. Check to see that film is tight around sound drum.
6. No picture appears on screen.
6. a. Open door in front of projection lens.
 - b. Check to see that projector and lamp switches are in the ON position.
 - c. Check to see that current supply cord is correctly connected at wall receptacle and Filmosound.
 - d. Check to see if projection lamp is burned out. If so, replace with another of correct voltage.
7. Picture brilliance seems insufficient.
7. a. Check to see that all windows and other light sources are properly covered or extinguished.
 - b. Check to see that current supply is of the correct voltage.
 - c. Darken room until screened picture seems brighter.
 - d. Clean projection lens, condensers, and reflector; remove any dirt from projection lamp.
 - e. Check to see if projection lamp has become excessively blackened. Effective lamp life may terminate before lamp actually burns out. Replace lamp if necessary.

Maintenance

Projection Lamp Replacement. Your Filmosound is equipped with a lamp of the voltage common to most communities. The next lamp you buy should be rated at the voltage of your line current. Using a lamp at higher than its rated voltage gives increased brightness but shorter life; at lower than rated voltage, increased life but lower illumination.

To replace a projection lamp, with projector switch PS, Figure 18, in the OFF position, unscrew the cap at the bottom of the lamphouse and allow the burned-out lamp to slide out into the hand, as in Figure 24. If the lamp is being replaced during a show, be careful as the lamp slides down to grasp it by the relatively cool pre-alignment gauge ring. This operation should be performed quickly, since a moment or two after the lamp is disengaged from the socket, the pre-alignment gauge ring, acting as a cooling flange, becomes quite warm.

Insert the new lamp with the vertical tongue on the prealignment gauge

ring toward the front of the projector and revolve it slightly one way or the other until the tongue settles into the prealignment gauge slot in the bottom of the lamphouse.

Replace the screw cap, making sure that it screws in squarely and tightly to lock the lamp in proper position.

Never attempt to change a lamp with the current on.

Since the lamp is designed to burn base down, the machine must not be turned upside down or laid on its side while the lamp is lighted.

Cleaning Optical and Film Handling Parts. At any time that seems necessary, clean: (1) projection lens, (2) removable gate shoe, (3) aperture, (4) film channel, (5) condensers, (6) lens and mirror of sound optical system, and (7) reflector.

To remove the projection lens L, Figure 25, for cleaning, loosen lens locking screw LL, Figure 25, and pull forward on the lens barrel. The front and rear elements are then accessible for cleaning. If only a slight amount of dust has accumulated, remove with B&H lens cleaning tissue. If, how-

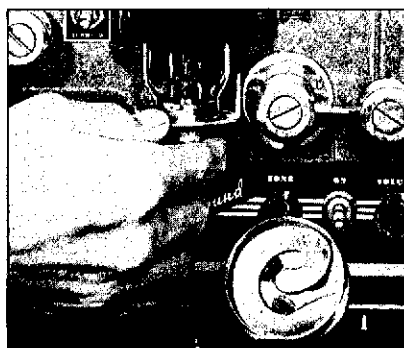

Figure 24
Lamp replacement

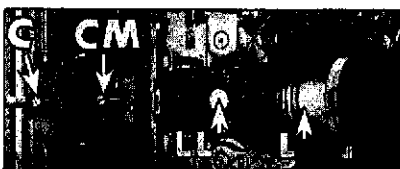

Figure 25
C Main condenser
CM Magnilite condenser
L Lens
LL Lens locking screw

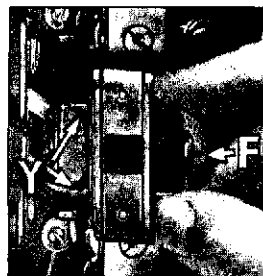

Figure 26
F Removable gate shoe frame
Y Guides

ever, fingerprints, oil, grease, or other accumulations of dirt are present, wipe B&H Lens Cleaning Fluid on the lens surfaces and follow with a thorough cleaning with lens cleaning tissue. Use B&H Lens Cleaning Fluid only—use no other cleaning agent as it may damage the Filmocoted surfaces.

While the lens is out of position, clean the removable gate shoe, aperture, and film channel. To remove the gate shoe for cleaning, grasp the metal frame F, Figure 26, and withdraw. Use no tools! Clean and polish with a soft cloth. If dirt or emulsion has gathered and hardened on the shoe, remove by rubbing with a soft dampened cloth. To avoid scratching polished surface, use no sharp tools!

Clean the aperture and film channel by opening the gate and inserting the brush into the channel in a vertical position. With the gate partially closed, move the brush up and down to remove all dirt and emulsion. The machine must not be running.

To return the removable gate shoe to position, place the guides Y, Figure 26, in the grooves formed by the metal plate attached to the back of the lens carrier and push the shoe

inward. An audible click will be heard when the metal frame F, Figure 26, is correctly positioned.

Close film gate, return lens to position in carrier, and tighten lens locking screw LL, Figure 25, securely.

Remove the main condenser C, Figure 25, and the Magnilite condenser CM, Figure 25, from the projector for cleaning by pulling on the holder handle. Clean in the same manner as the lens and return to position.

To expose the lens and mirror of the sound optical system for cleaning, remove the exciter lamp compartment cover Z, Figure 8, as instructed in the paragraph, "Exciter Lamp Replacement." One face of the lens is exposed within the exciter lamp compartment and the other toward the sound drum; the mirror can be seen by looking down behind the sound drum from in front of and above the Filmosound. Clean both lens surfaces and the mirror with B&H lens cleaning tissue wrapped around the end of a toothpick—use no other materials. NEVER attempt to remove or adjust the lens of the sound optical system.

To expose the reflector for cleaning, grasp holder and pull out from the



Figure 27
BC Reflector holder

projector. A snap spring permits quick removal and insertion. (BC, Figure 27.) Clean the reflector in the same manner as the projection lens and return holder to position; tighten securely. The reflector is factory-adjusted.

Projector Lubrication. Correct lubrication will assure long, trouble-free life of the Filmosound; lack of oil will result in serious damage.

The projector is properly lubricated when it leaves the factory.

Oil cups and holes are readily accessible and should be given careful attention according to the chart below.

To saturate the felt reservoirs within the sprocket shafts, disconnect the projector from the line current and speaker, and lay it on its side. Insert the tip of the B&H oil can in the holes D, Figure 28, and squeeze the sides of the oil can 3 times.

After every 100 hours of use, remove thumb screw cap GG, Figure 29, and add Bell & Howell reel arm grease as necessary to grease cup EE, Figure 29. Replace cap and tighten securely.

After every 100 hours of operation, place one drop of oil on shafts of snubber SN and roller K, Figure 15, and on the shafts of the rollers at base of each reel arm, where film enters and leaves projector case. Do not lubricate feed arm spindle or pulley at any time.

Spring Belt Replacement. To replace the belt on the feed reel arm HR, Figure 6, unhook the belt at the join-

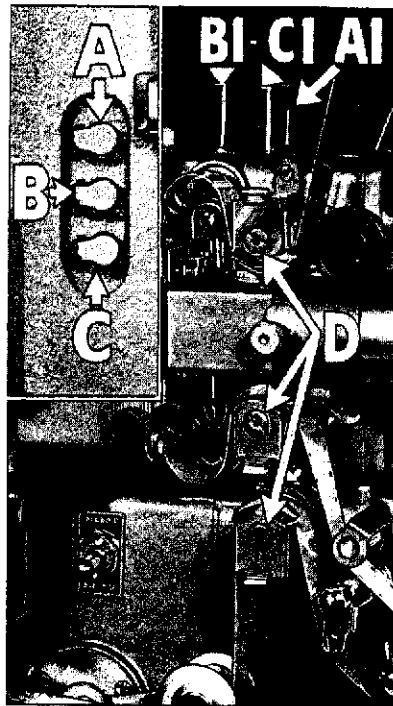

Figure 28

- A B C Oil cup caps
- A1 B1 C1 Matching oil cups
- D Sprocket oil holes

ing and draw it out of the projector and case. Insert one end of the new

Lubrication Chart (See Figure 28)

	Silent Speed	Sound Speed
Oil Cup A	One drop of B&H Projector Oil after each 8 hours of operation.	One drop of B&H Projector Oil after each 4 hours of operation.
Oil Cups B and C	One drop of B&H Projector Oil after each 32 hours of operation.	One drop of B&H Projector Oil after each 16 hours of operation.
Oil Holes D	Saturate felt reservoirs every 6 months.	Saturate felt reservoirs every 3 months.

belt into the slot at the base of the feed reel arm and down into the feed drive pulley slot in the gear case. Push the belt into this slot until the end, having wound itself around the concealed pulley, reappears at the opposite edge of the slot. Pull the end up, lead it through the slot at the base of the feed reel arm, and hook the two ends together to form a continuous belt. Place the belt, without a twist, around the pulley on the feed reel arm.

To replace a spring belt on take-up reel arm JS, Figure 6, unhook the belt at the joining and draw it out of the projector and case. Insert one end of the new belt into the slot at the base of the take-up reel arm, place the belt around take-up drive pulley RP, Figure 6, and lead it out of the slot. Hook the two ends together to form a continuous belt and place the belt, without a twist, around pulley Q, Figure 17.

Fabric Take-up Belt Replacement.

To replace a worn belt, with the take-up mechanism set to rewind film, remove the old belt by pulling it from over the two pulleys Z1 and Z2, Figure 29, and from under the belt guides X1 and X2, Figure 29. *It is not necessary to disassemble the take-up mechanism to replace the belt.* Place the new belt over the upper pulley Z1, pressing it under the upper guide X1, and place it around the lower pulley Z2 and under the lower belt guide X2. Set the take-up mechanism to take up film.

Exciter Lamp Replacement. The exciter lamp is beneath the three-sided metal cover Z, Figure 8. Unscrew the thumb nut which holds the cover in place, and remove the cover. Press the lamp down, turn it counter-clock-

wise slightly, and lift it out. Insert a new lamp, reversing the above procedure. Since the slots in the exciter lamp prefocusing ring will fit over the socket bayonet pins in only one position, the lamp cannot be inserted incorrectly. Be sure when replacing the lamp to turn it as far to the right (clockwise) as it will go; the lamp will then be correctly aligned. Wipe the lamp (as a lens) to remove all finger marks. Then replace cover Z and tighten thumb nut securely.

Tube Replacement. All tubes should be tested at a B&H Authorized Service Station about once a month, if projector is used frequently, and replaced if they are not up to standard. Gradual deterioration of the tubes before they actually stop functioning detracts from the amplifier's effective-

Figure 29

- EE Grease cup
- GG Thumb screw cap
- X1 Upper belt guide
- X2 Lower belt guide
- Z1 Upper pulley
- Z2 Lower pulley

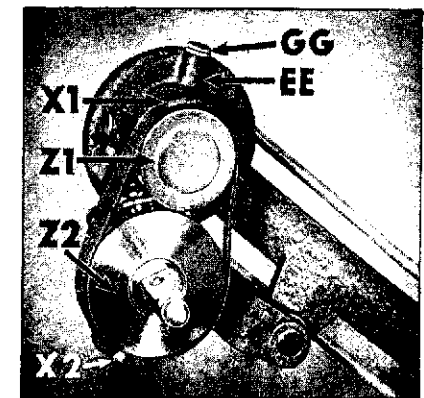

ness. A complete set of spare tubes should be carried with Filmosound at all times.

If a defective amplifier tube is suspected, remove tubes and replace with a complete new set.

To replace tubes of amplifier, it is necessary to remove the amplifier from the Filmosound. To remove the amplifier, lay the projector on its side and, with a screw driver or a coin, remove the four screws H, Figure 30. Pull amplifier out far enough to reach exciter lamp lead wire plug LP, Figure 31; remove plug from receptacle LR, Figure 31, before completely removing amplifier from projector. Remove the amplifier by pulling straight out, being careful not to allow it to drop and damage the tubes.

Remove each tube, and replace it with another of the same type from the new set; the label on the tube will identify the tube type. Although tubes used in the Filmosound projector may be obtained from most radio stores, it is advisable to use tubes tested by Bell & Howell and sold by your B&H dealer.



Figure 31
LP Lead wire plug
LR Receptacle

To expose the photocell, with Filmosound line cord disconnected, unscrew thumbscrew TS, Figure 32, and lift off shell SH, Figure 32. Remove photocell PE, Figure 33, and replace with another. Return shell SH to position over photocell and first amplifier tube, placing contact pins CO, Figure 33, on shell edge in holes PH, Figure 33, in amplifier chassis. Tighten thumbscrew TS to top of shell as firmly as possible *without the use of tools*.

When all of the tubes have been replaced with new tubes and have been correctly seated in their sockets, re-

place the amplifier, reversing the removal procedure. *Be sure* to re-connect the exciter lamp lead wire plug LP, Figure 31.

Since only one of the tubes removed from the amplifier may be defective, have the complete set tested at a B&H Authorized Service Station.

The tubes found in good condition may be carried as spares; the tubes found defective should be replaced with new tubes of the same type in order to keep the spare set complete.

Fuse Replacement. A 1½-ampere fuse is provided in the projector amplifier. Check it immediately if the exciter lamp fails to light. The fuse will burn out if direct current is fed into the amplifier supply receptacle.

To replace the fuse, disconnect the Filmosound line cord from the power source. Insert the edge of a coin into the slot FR, Figure 34, and turn coin in a counter-clockwise direction until the red portion of the fuse holder may be removed. Remove the fuse from the holder and replace it with another 1½-ampere fuse; never use a fuse larger than the 1½-ampere size.

Pilot Light Replacement. To replace the pilot light, turn cap PL, Figure 8, in a counter-clockwise direction until it may be removed. Unscrew the burned-out lamp and replace it with another of the same voltage. Replace cap PL and tighten securely.

Removing the Projector from the Case. At any time it seems necessary to remove the projector from the case, proceed as follows:

Disconnect the line cord and speaker cable, remove the front and rear reel arms, and draw the two spring belts to the inside of the case. Remove tubes to oil cups from cups by bending toward you until lower end of tube comes out of cup.

Lay the projector on its side with the two doors up. Open both doors; remove take-up reel from position on lower door and leave doors open. Turn tilt adjustment knob TN, Figure 8, clockwise to the stopping point. Loosen four screws RS, Figure 30, until they may be removed together with washers WW, lower cushions XX, metal sleeves YY and upper cushions ZZ, Figure 35. Then draw projector and amplifier out of case, as in Figure 35, being careful not to drop it and damage the tubes.

To replace, lay case on its side and open both case doors. With control side up, slip top of projector into bottom of case and up into position. Place one rubber cushion ZZ, Figure

Figure 30

H Amplifier retaining screws
RS Projector retaining screws

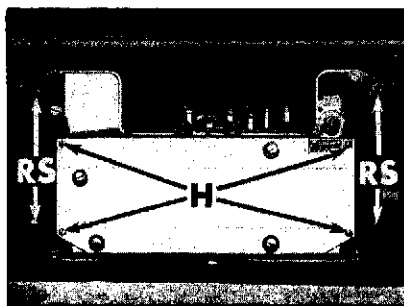

Figure 32

SH Shell
TS Thumb screw

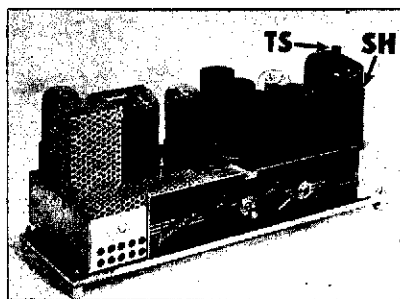

Figure 33

CO Contact pins
PE Photocell
PH Holes

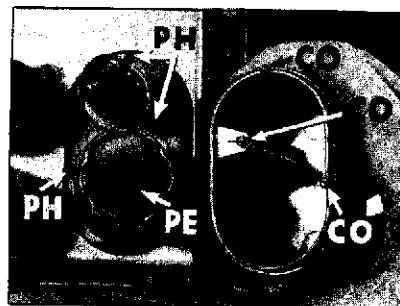

Figure 34
FR Fuse holder slot



35, between each of four brackets VV and UU, Figure 35. With washer WW, sleeve YY and cushion XX, Figure 35, positioned on screw RS in order named, replace the four screws RS and tighten securely. Replace the reel arms, position the two spring belts, return oil cup tubes to position, and make the electrical connections; the projector then will be ready for further use.

Speaker Cord Maintenance. If, at any time, cord sticks together during storage on brackets, shake a generous amount of talcum powder into a soft cloth and pass the length of cord through the cloth.



Figure 35

- RS Screws
- UU Brackets
- VV Brackets
- WW Washers
- XX Rubber cushions
- YY Metal sleeves
- ZZ Rubber cushions

Instructions for

FILMOSOUND Models 285-B and -B1

Operation of the Filmosounds 285-B and -B1 differs from that of the Filmosound 285-C as follows:

Electrical Connections—8" Speaker. When all necessary accessories have been removed from speaker case and it has been correctly positioned at the front of the room, remove plug CB from receptacle MS, Figure 36.

When show is over, remove plug MP from receptacle S and plug CB from receptacle MS. Turning handle CH, Figure 36, in a clockwise direction, wind speaker cable evenly and compactly onto reel N.

Speaker cable is wound on reel N, Figure 36, and emerges through the hole in the lower right side of the front panel of the case. Holding plug on this end of speaker cable, withdraw the cable as you walk toward projector; place cable where audience cannot trip over it. Insert male plug MP, Figure 5, into 16-ohms receptacle S, Figure 5. Returning to speaker case, insert plug CB into receptacle MS, Figure 36, and close case door.

Electrical Connections—12" Speaker. Using one 12" speaker: When all

necessary accessories have been removed from speaker case and it has been correctly positioned at the front of the room, connect female end WP, Figure 37, of speaker cable to male plug VR, Figure 37, draw cable out of slot in right side of case door and close door.

Figure 37
VR Male plug
WP Female plug

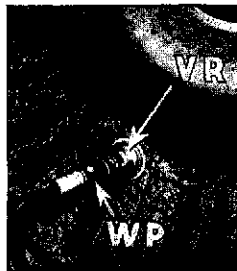

Uncoiling cable as you walk toward the projector, place cable where audience cannot trip over it. Insert male plug MP, Figure 5, into 16-ohms receptacle S, Figure 5.

Using two 12" speakers: When all necessary accessories have been removed from each speaker case, carry the speakers and their cables to the front of the room. Place one speaker

at each side of the screen, or one at each corner of the room, and above the floor, but not so high as to interfere with the picture. Locate each speaker at least 18 inches in front of any obstructing surface. Connect female end of second speaker cable to male plug of second speaker. Draw cable through slot in right side of case door and close door. Insert male plug of second speaker cable into female receptacle on first speaker chassis. Draw first speaker cable through slot in right side of case door and close door. Uncoiling cable as you walk toward projector, place cable where the audience cannot trip over it. Insert male plug MP, Figure 5, of first speaker cable into 8-ohms receptacle S, Figure 5.

Figure 36

- CB Plug
- CH Handle
- HR Feed reel arm
- MS Receptacle
- N Speaker cord reel

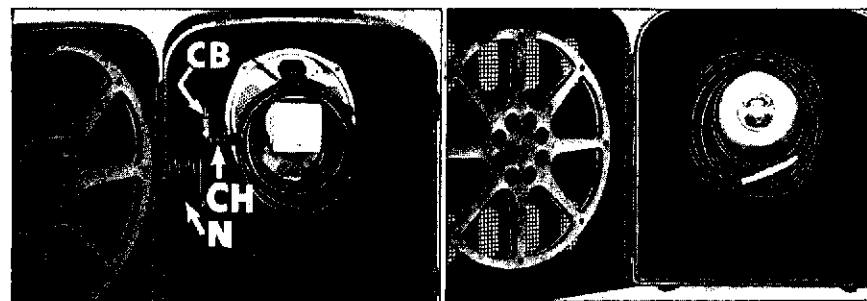

8" Speaker

12" Speaker

Instructions for FILMOSOUND Model 285-B2

Operation of the Filmosound 285-B2 differs from that of the Filmosound 285-C as follows:

Positioning of Projection Units. Place the Filmosound at the rear of the room on a stand or table of a height which will permit projecting over the heads of the audience. Set up the projection screen, at the front of the

room, according to the instructions accompanying the model to be used.

Unfasten two latches on rear door of power speaker and open door. Remove Y cord, speaker-to-projector cable, line cord and take-up reel from carrying positions. Carry the speaker, line cord, and speaker-to-projector cable to the front of the room. Place the speaker as nearly as possible at the center of the screen and above the floor, but not so high as to interfere with the picture. Locate the speaker at least 18 inches in front of any obstructing surface.

Electrical Connections — Speaker. With line switch ND, Figure 40, in the OFF position, insert female plug MG, Figure 39, of power speaker line cord into receptacle KR, Figure 39; plug other end of line cord into wall receptacle supplying 105- to 130-volt, 25-cycle or 50- to 60-cycle alternating current. Connect plug AR, Figure 39, of speaker-to-projector cable to receptacle DP, Figure 39. For operation of power speaker on 115-volt direct current or 220-volt alternating current, see pages 34 and 35.

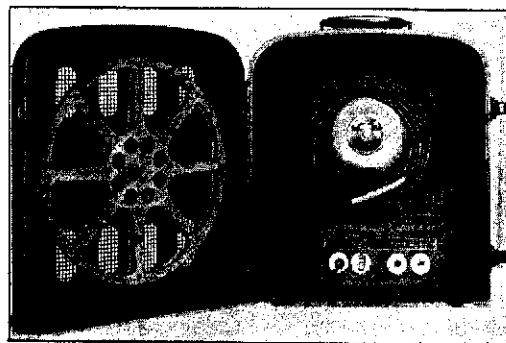

Figure 38
Accessories in carrying position.

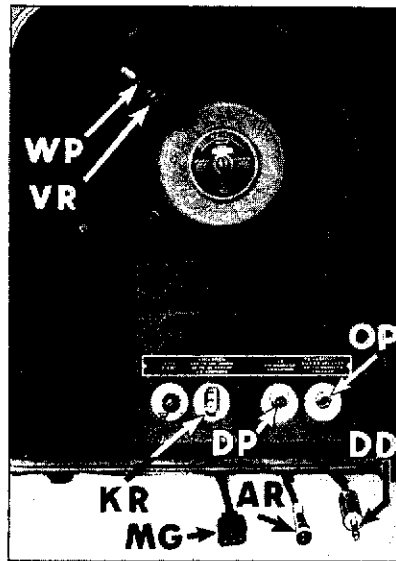

Figure 39

AR Female plug
DD Extra speaker cable plug
DP Receptacle
KR Power supply receptacle
MG Female plug
OP Extra speaker jack
VR Male plug
WP Female plug

Draw cable out of slot in right side of case door and close door. Uncoil-

ing speaker-to-projector cable as you walk toward projector, place cable where audience cannot trip over it. Figure 41a shows positions and connection of Filmosound and power speaker.

On those occasions when even greater sound volume is desired, add one or more extra power speakers. To connect two or more power speakers (see Figure 41b): Connect plug MG of second power speaker line cord to receptacle KR. Connect plug AR of speaker-to-speaker cable to receptacle DP. With connections for first power speaker made in the usual way, connect plug DD of speaker-to-speaker cable to jack OP on first speaker amplifier. Connect each additional power speaker to the one before it, using the speaker-to-speaker cable; since all connectors are polarized and speaker amplifier receptacles are clearly identified, connections can be made only correctly.

When desired, a regular speaker may be used with the power speaker or the power speaker itself may be used as a regular speaker. To use a regular speaker with the power speaker (see Figure 41c): Connect plug AR of speaker-to-speaker cable to receptacle VR of regular speaker. With connections for power speaker made in the usual way, connect plug DD of speaker-to-speaker cable to jack OP on power speaker amplifier. To use the power speaker as a regular speaker (see Figure 41d): Remove plug WP, Figure 39, from receptacle VR, Figure 39. Connect plug AR of speaker-to-projector cable to receptacle VR, Figure 39. No further electrical connections for speaker are necessary, since amplifier of speaker will not be used.

Electrical Connections — Projector. When speaker(s) has been set up and connected, insert plug MP, Figure 5, of speaker-to-projector cable into 16-ohms receptacle S, Figure 5. With all controls on the Filmosound in the OFF position, insert plug FP, Figure 5, into projector receptacle PR, Figure 5. Plug other end of line cord into a wall or extension cord receptacle supplying 105- to 130-volt, 25-

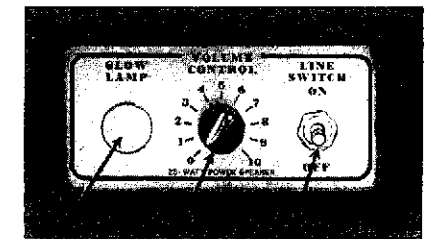

Figure 40

GL Glow lamp
ND Line OFF-ON switch
SV Volume control

cycle or 50- to 60-cycle alternating current.

Preparing to Operate. Set up the Filmosound 285-B2, position the light beam on the screen, and focus the lens following the instructions given on page 7 under the above heading. Then:

Place projector switch PS, Figure 8, in the OFF position. Set power speaker line switch ND, Figure 40, at ON. If the speaker electrical connections have been made correctly, glow lamp GL, Figure 40, will now light up to indicate that the amplifier is operating. Set volume control SV, Figure 40, midway between the 7 and 8 marks,

for average acoustical conditions. The sound volume may now be controlled by the projector volume control. If more than one power speaker is being used, turn on each speaker and set the volume control as above.

Set amplifier switch G, Figure 8, at ON. Allow about one minute for the tubes to heat; then, move volume control V, Figure 8, in a clockwise direction until a hiss is heard in the speaker(s). At the same time a light should be seen from behind exciter lamp cover Z, Figure 8. If these conditions exist, electrical connections and other adjustments have been made correctly.

Since the power speaker volume control setting may require adjustment to give best coverage of the area, it is recommended that the Filmosound and power speaker(s) be set up and checked in advance of the actual showing.

At that time, with the Filmosound threaded with sound film and speaker and projector amplifiers operating, the operator should check, by ear, the sound volume at various points in the room. If, with the speaker volume control set midway between the 7 and 8 marks and the projector volume control at or close to its minimum position, the sound volume is too great, set the speaker volume control at a lower point. Do not set the speaker volume control at a point lower than the 1 mark since the sound will then be almost inaudible even with the projector volume control at the maximum position. If, with the speaker volume control set midway between the 7 and 8 marks and the projector volume control at or close to its maximum position, the sound volume is not sufficient, set the speak-

er volume control at a higher point or the 10 position.

Once the best volume control setting of the speaker(s) has been found, adjustment of the projector volume control at the start of or during the show will handle any necessary compensation for acoustics altered by the presence of an audience.

Place all projector and power speaker controls in the OFF position and prepare to thread the projector in the usual way.

Projecting Sound Film. The Filmosound 285-B2 operates in the same manner as the Filmosound 285-C. However, *be sure to turn on power speaker amplifier when it is to be used.*

Projecting Silent Films. Follow the instructions given for Filmosound 285-C. Place power speaker controls in the OFF position unless oral comments are to be made through the speaker by means of a microphone, or musical accompaniment is to be reproduced by means of a turntable.

Microphone. Follow the instructions given for the use of a microphone with the Filmosound 285-C, *being sure to place power speaker controls in the ON position if power speaker amplifier is to be used.*

Phonograph Turntables. Follow the instructions given for the operation of a turntable with the Filmosound 285-C, *being sure to place power speaker controls in the ON position if power speaker amplifier is to be used.*

Public Address System. Follow the instructions given for the Filmosound 285-C under the above heading, being

41a

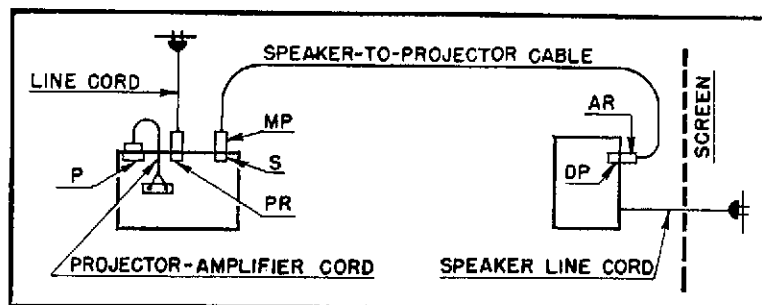

41b

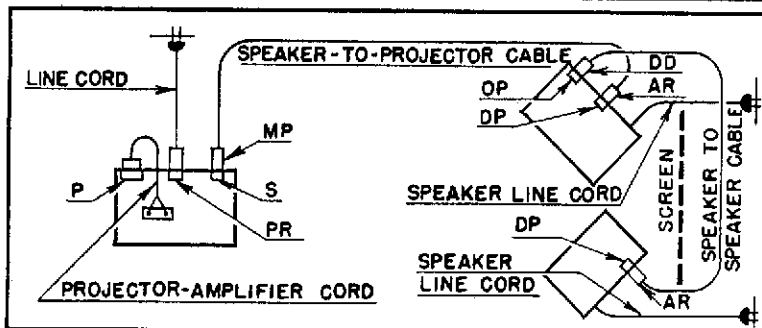

41c

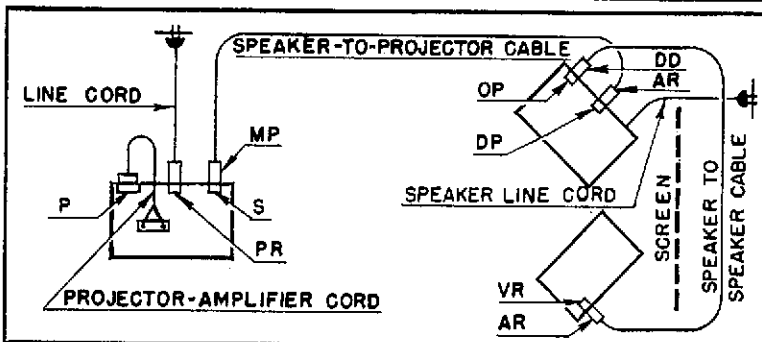

41d

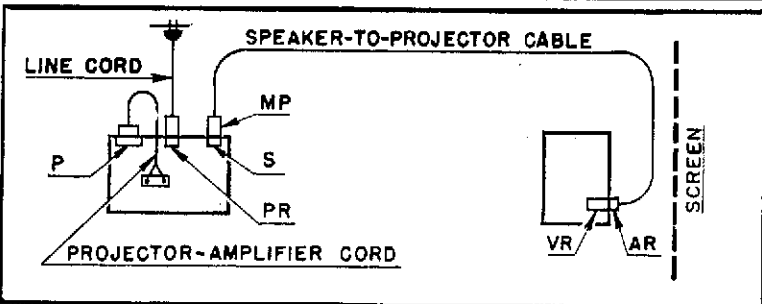

sure to connect power speaker to power supply if speaker amplifier is to be used and to place speaker controls in the ON position.

Operation on 115-volt Direct Current. If projector and/or power speaker amplifier is to be operated on direct current, a DC to AC converter having a capacity of 100 watts is necessary for the operation of *each amplifier*. The film-moving mechanism will operate on either alternating or direct current without any changes.

Connect the converter to the direct current outlet with a line cord. Connect the female end of a second line cord to projector receptacle PR, Figure 5, and the male end to one socket of the direct current outlet. Plug the male end of the Filmosound line cord into the AC output of the converter and the flat arm AP, Figure 5, into amplifier receptacle P, Figure 5.

When using speaker amplifier on direct current, connect a second converter to the direct current outlet with a line cord. Connect the male end of the power speaker cord into the AC output of the converter and the flat arm of the cord into power speaker receptacle KR, Figure 39.

When correctly positioned and connected, the units will appear as in Figure 42. Operation is the same as for alternating current.

Operation on 220-volt, 25-cycle or 50- to 60-cycle Alternating Current. If Filmosound and/or power speaker is to be operated on 220-volt alternating current, a 1500-watt, 220- to 115-volt transformer is required. Plug the 220-volt side of the transformer into the alternating current outlet. Connect the female end (FP, Figure 5) of the projector cord to the projector as for normal operation (see "Electrical Connections—Projector"). Connect power speaker line cord to speaker as for normal operation. Plug male ends of line cord and speaker line cord into a double socket; plug double socket into 115-volt side of transformer. Operation is the same as for *115-volt alternating current*.

Projection Problems and Remedies.

- 3. g. Check to see that power speaker has been connected to current supply and to Filmosound, or that power speaker has been correctly connected for use as a regular speaker and to Filmosound.

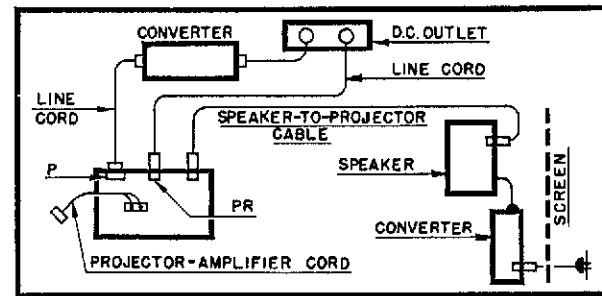

Figure 42
Arrangement and connection of Filmosound units for operation on 115-volt DC

- h. Check to see that power speaker amplifier has been turned on and that speaker volume control has been set above the 0 position.
 - i. Check to see if fuse in power speaker amplifier is blown.
 - j. Check to see that power speaker amplifier tubes are correctly positioned in correct sockets.
 - k. Replace power speaker amplifier tubes with a complete new set.
- 4. f. Replace tubes of projector and power speaker amplifiers with complete new sets.
 - g. Change power speaker volume control setting.

Tube Replacement. Remove and replace projector amplifier tubes in the same manner as for the Filmosound 285-C.

To expose the amplifier (see Figure 44) of the power speaker for tube replacement, place one hand on either side of the amplifier cover, as shown in Figure 43, and pull forward on the cover until it slips from over the amplifier. It is not necessary to remove the amplifier from the speaker. Remove and replace the power speaker amplifier tubes in the same manner as for the projector amplifier tubes. When all of the tubes have been replaced with new tubes and have been correctly seated in their sockets, replace the amplifier cover, sliding the edges of the cover under the amplifier base plate. Press the cover firmly back into position.

Fuse Replacement—Power Speaker. A 3-ampere fuse is provided in the power speaker amplifier. Check it immediately if the glow lamp on speaker

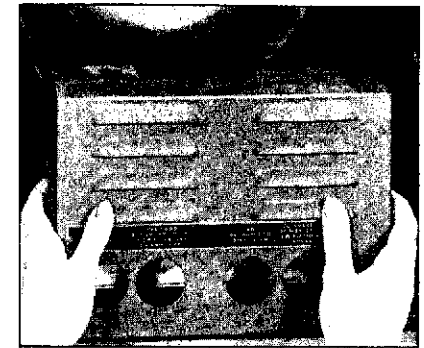
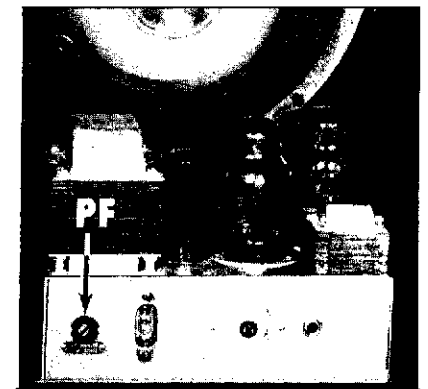

Figure 43
Removing cover of power speaker amplifier

control panel fails to light or speaker does not operate. The fuse will burn out if direct current is fed into the amplifier supply receptacle.

To replace the fuse, disconnect the power speaker line cord from the power source. Insert the edge of a coin into the slot PF, Figure 44, and turn coin in a counter-clockwise direction until the red portion of the fuse holder may be removed. Remove

Figure 44
PF Fuse holder slot



the fuse from the holder and replace it with another 3-ampere fuse; never use a fuse larger than the 3-ampere size.

Glow Lamp Replacement. To replace glow lamp GL, Figure 40, unscrew the

plastic shell; turn burned-out bulb counter-clockwise until it may be removed. Replace it with another ½-watt lamp (General Electric NE-51). Pressing lamp firmly into socket, turn clockwise as far as it will go. Replace plastic shell and tighten securely.

Special Instructions for Power Speaker or 12" Regular Speaker equipped with Cordomatic Speaker Cord Reel

If your power speaker or 12" regular speaker is equipped with a Cordomatic speaker cord reel, the speaker cable emerges from the case through the hole in the lower right side of the front panel. It is wound within the case on an automatic cable control reel.

Withdraw the cable from the speaker by exerting a steady, even pull, until the desired length has been reached. Release tension on the cable and allow it to rewind slightly until the locking mechanism holds it firmly in position. (Every other click of the ratchet mechanism will hold the reel.)

To rewind the speaker cable, disconnect the plug and pull (do not jerk)

the cable until a click is heard, indicating that the locking mechanism has been released. Holding the plug, walk toward the speaker case, allowing the cable to wind compactly onto the reel within the speaker case. This insures longer wear, and, in addition, prevents the cable from winding up loosely and thereby bulking up and crowding the inside of the reel casing compartment before all of the cable has been taken up.

If, at any time, the rubber-covered cable becomes sticky, shake a generous amount of talcum powder into a soft cloth and allow the cable to pass through the cloth as it is being rewound.

PROFESSIONAL SERVICING

Fine equipment that it is, your Bell & Howell camera and projector need only a minimum of expert care. You might think, because of their precision construction and efficient operation, that they need no servicing at all. *This is not true.* For, just as all fine equipment demands professional care, so Bell & Howell cameras and projectors must be serviced regularly to keep them in their original perfect condition.

The low service requirements of Bell & Howell equipment are due in part to excellent design, materials, and craftsmanship. Another reason for the long, trouble-free lives of B&H equipment lies in the fine service, advice, and operator training provided by B&H Approved Service Stations. Cue to your responsibility is the old saw, "An ounce of prevention is worth a pound of cure," for it's you who must see that your equipment gets the care it needs *before* it needs it.

To be sure this small but vital bit of service is correctly done, you will want to turn your equipment in to your local dealer to be taken to the nearest Approved Service Station, Bell & Howell factory branch, or the B&H home plant in Chicago.

Many owners follow our suggestion that every projector, even though apparently in first-class condition, be serviced annually. The equipment is thoroughly cleaned, lubricated, and inspected. Any parts which show serious wear are replaced. Then, after careful testing, it is returned ready for another year of rigorous use. The cost of this preventive service is nominal, and results in dependable performance are more than satisfactory.

Supplement this yearly servicing with good, everyday care, proper storage and maintenance; the added appreciation of all who view your movies will be your reward.

BELL + HOWELL

7100 N. McCormick Road Chicago, Illinois
60545

GENERAL SERVICE BULLETIN

G-85-224

SUBJECT

DISCONTINUED SERVICE & PARTS

DATE 5-20-85

Effective immediately, repairs, repair parts and service manuals for models 173, 273, 138, 140, 156, 179, 279, 185, 285, 385, 302, 399, 8302 and 8399 are no longer available from Bell & Howell Company.

If you require parts or repairs for any of these models, we suggest you contact:

International Cinema Equipment Co.
100 N.E. 39th Street
Miami, Florida 33137-3632
(305) 573-7339 voice
(305) 573-8101 fax
URL: www.iceco.com

They can furnish you with the parts or repair expertise necessary to satisfy your customers' needs.

GENERAL SERVICE DEPARTMENT

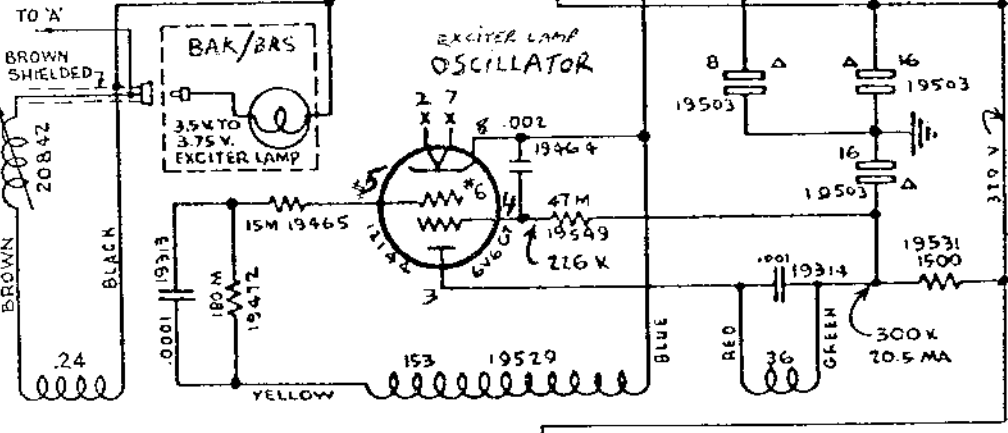
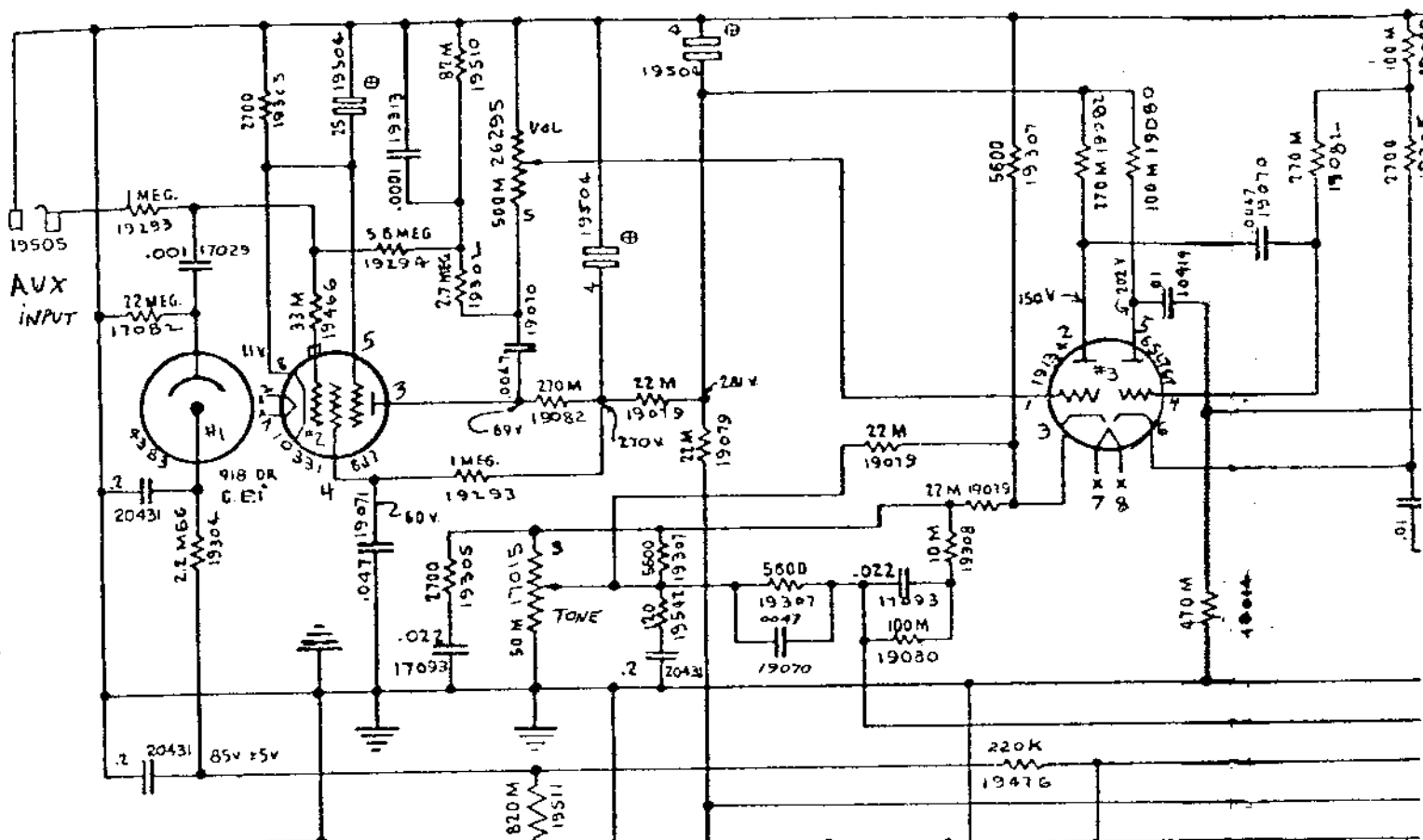

M = 1,000 (K)
FOR RESISTORS
ON THIS
SCHEMATIC ONLY

WIRE COLOR CODE			
WHITE	GROUND	BROWN	SCREEN
YELLOW	CATHODE	BLUE	PLATE
RED	B+	BLACK	HEATER
GREEN	GRID	BLACK & WHITE	B-

"S" INDICATES TERMINAL AT CLOCKWISE STOP. ALL VOLTAGES MEASURED WITH RESPECT TO CHASSIS & TONE CONTROL BASS.
⊕ Δ INDICATES CAPACITORS IN BANK.

TUBE LAYOUT

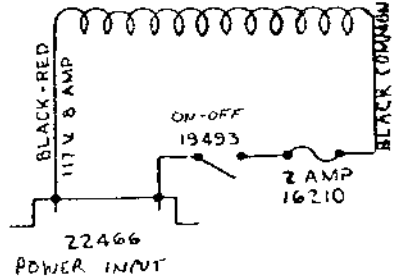
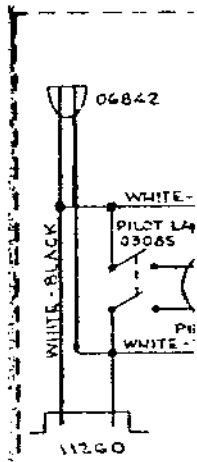
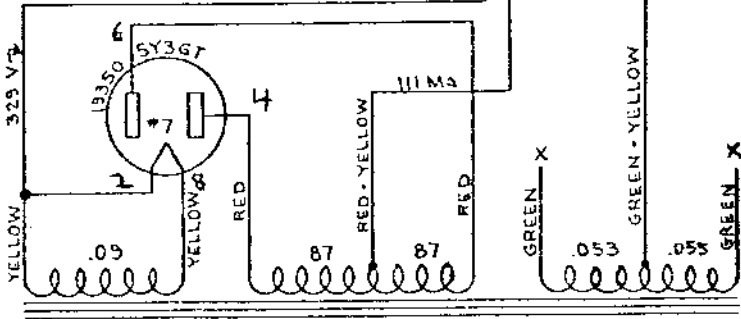

NOT INCLUDED IN PROJECT WIRING

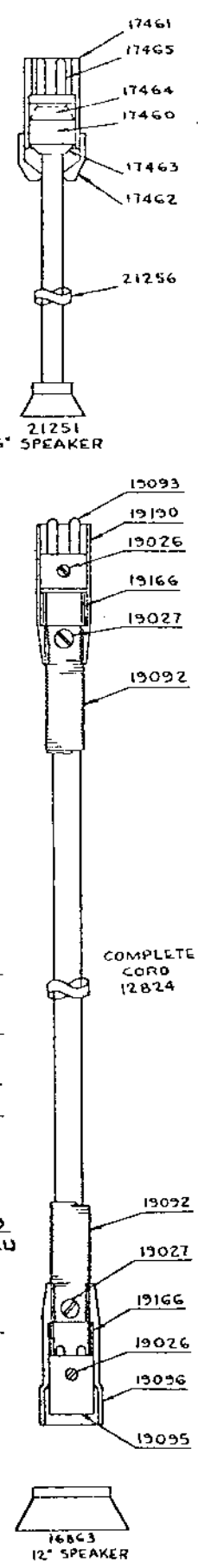
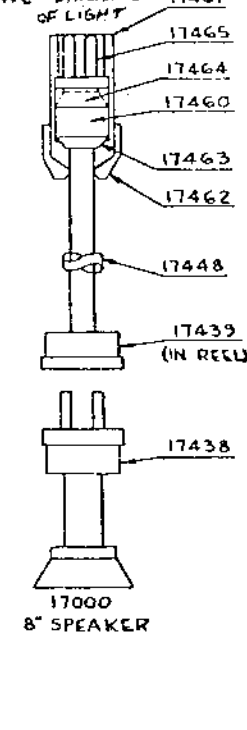
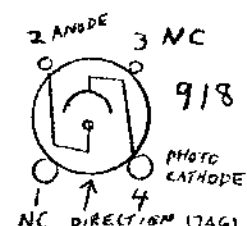
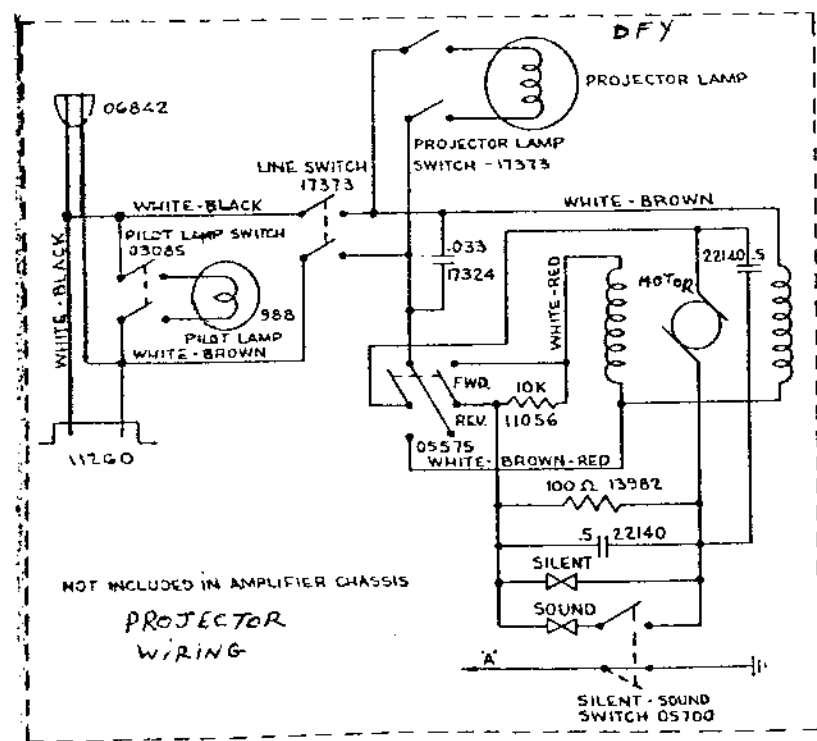
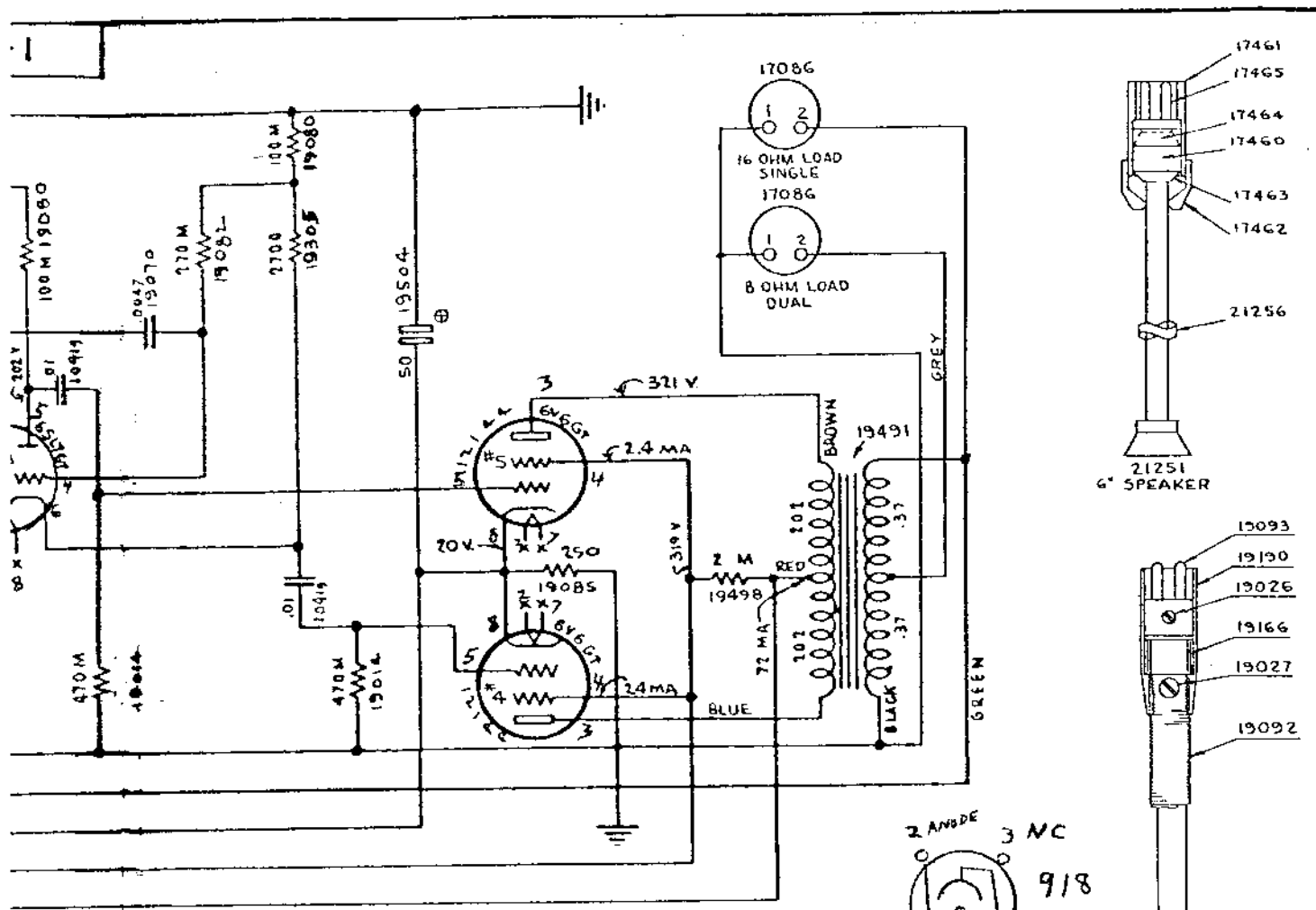

BELL + HOWELL 16MM
FILMOSOUND PROJECTOR
AMPLIFIER # 07137
MODEL # 285

50 TO 60 CYCLES

Bell & Howell Co. Chicago U.S.A.		
14 W. AMPLIFIER WIRING DIAGRAM FOR DESIGNS 285 (ALL) (07137)		
DATE 11-29-55	SERVICE DATA	DRAWN <i>ad</i> APVD. <i>ld</i>

055 GREEN X
BLACK COMMON