

Film-Tech

The information contained in this Adobe Acrobat pdf file is provided at your own risk and good judgment.

These manuals are designed to facilitate the exchange of information related to cinema projection and film handling, with no warranties nor obligations from the authors, for qualified field service engineers.

If you are not a qualified technician, please make no adjustments to anything you may read about in these Adobe manual downloads

www.film-tech.com

CAUTION AVIS

RISK OF ELECTRIC SHOCK
DO NOT OPEN
RISQUE DE CHOC ELECTRIQUE
NE PAS OUVRIR

CAUTION: TO REDUCE THE RISK OF ELECTRIC SHOCK
DO NOT REMOVE COVER (OR BACK)
NO USER-SERVICEABLE PARTS INSIDE
REFER SERVICING TO QUALIFIED PERSONNEL

 ATTENTION: POUR EVITER LES RISQUES DE CHOC
ELECTRIQUE, NE PAS ENLEVER LE COUVERCLE. AUCUN
ENTRETIEN DE PIECES INTERIEURES PAR L'USAGER. CONFIER
L'ENTRETIEN AU PERSONNEL QUALIFIE.

 AVIS: POUR EVITER LES RISQUES D'INCENDIE OU
D'ELECTROCUTION, N'EXPOSEZ PAS CET ARTICLE
A LA PLUIE OU A L'HUMIDITE



The lightning flash with arrowhead symbol within an equilateral triangle is intended to alert the user to the presence of uninsulated "dangerous voltage" within the product's enclosure that may be of sufficient magnitude to constitute a risk of electric shock to persons.

Le symbole éclair avec point de flèche à l'intérieur d'un triangle équilatéral est utilisé pour alerter l'utilisateur de la présence à l'intérieur du coffret de "voltage dangereux" non isolé d'ampleur suffisante pour constituer un risque d'électrocution.



The exclamation point within an equilateral triangle is intended to alert the user of the presence of important operating and maintenance (servicing) instructions in the literature accompanying the appliance.

Le point d'exclamation à l'intérieur d'un triangle équilatéral est employé pour alerter les utilisateurs de la présence d'instructions importantes pour le fonctionnement et l'entretien (service) dans le livret d'instruction accompagnant l'appareil.

SAFETY INSTRUCTIONS

1. **Read Instructions** — All the safety and operation instructions should be read before this Mackie product is operated.
2. **Retain Instructions** — The safety and operating instructions should be kept for future reference.
3. **Heed Warnings** — All warnings on this Mackie product and in these operating instructions should be followed.
4. **Follow Instructions** — All operating and other instructions should be followed.
5. **Water and Moisture** — This Mackie product should not be used near water — for example, near a bathtub, washbowl, kitchen sink, laundry tub, in a wet basement, near a swimming pool, swamp or salivating St. Bernard dog, etc.
6. **Cleaning** — Clean only with a dry cloth.
7. **Ventilation** — This Mackie product should be situated so that its location or position does not interfere with its proper ventilation. For example, the Component should not be situated on a bed, sofa, rug, or similar surface that may block any ventilation openings, or placed in a built-in installation such as a bookcase or cabinet that may impede the flow of air through ventilation openings.
8. **Heat** — This Mackie product should be situated away from heat sources such as radiators, or other devices which produce heat.
9. **Power Sources** — This Mackie product should be connected to a power supply only of the type described in these operation instructions or as marked on this Mackie product.
10. **Power Cord Protection** — Power supply cords should be routed so that they are not likely to be walked upon or pinched by items placed upon or against them, paying particular attention to cords at plugs, convenience receptacles, and the point where they exit this Mackie product.
11. **Object and Liquid Entry** — Care should be taken so that objects do not fall on, and liquids are not spilled into, this Mackie product.

12. **Damage Requiring Service** — This Mackie product should be serviced only by qualified service personnel when:

- A. The power-supply cord or the plug has been damaged; or
- B. Objects have fallen, or liquid has spilled into this Mackie product; or
- C. This Mackie product has been exposed to rain; or
- D. This Mackie product does not appear to operate normally or exhibits a marked change in performance; or
- E. This Mackie product has been dropped, or its chassis damaged.

13. **Servicing** — The user should not attempt to service this Mackie product beyond those means described in this operating manual. All other servicing should be referred to the Mackie Service Department.

14. To prevent electric shock, do not use this polarized plug with an extension cord, receptacle or other outlet unless the blades can be fully inserted to prevent blade exposure.

Pour prévenir les chocs électriques ne pas utiliser cette fiche polarisée avec un prolongateur, un prise de courant ou une autre sortie de courant, sauf si les lames peuvent être insérées à fond sans laisser aucune paroi à découvert.

15. **Grounding or Polarization** — Precautions should be taken so that the grounding or polarization means of this Mackie product is not defeated.

16. **Power Precaution** — Unplug this Mackie product during lightning storms or when unused for long periods of time.

17. This apparatus does not exceed the Class A/Class B (whichever is applicable) limits for radio noise emissions from digital apparatus as set out in the radio interference regulations of the Canadian Department of Communications.

ATTENTION — Le présent appareil numérique n'émet pas de bruits radioélectriques dépassant les limites applicables aux appareils numériques de class A/de class B (selon le cas) prescrites dans le règlement sur le brouillage radioélectrique édicté par les ministere des communications du Canada.

18. Exposure to extremely high noise levels may cause permanent hearing loss. Individuals vary considerably in susceptibility to noise-induced hearing loss, but nearly everyone will lose some hearing if exposed to sufficiently intense noise for a period of time. The U.S. Government's Occupational Safety and Health Administration (OSHA) has specified the permissible noise level exposures shown in the following chart.

According to OSHA, any exposure in excess of these permissible limits could result in some hearing loss. To ensure against potentially dangerous exposure to high sound pressure levels, it is recommended that all persons exposed to equipment capable of producing high sound pressure levels use hearing protectors while the equipment is in operation. Ear plugs or protectors in the ear canals or over the ears must be worn when operating the equipment in order to prevent a permanent hearing loss if exposure is in excess of the limits set forth here.

Duration Per Day In Hours	Sound Level dBA, Slow Response	Typical Example
8	90	Duo in small club
6	92	
4	95	Subway Train
3	97	
2	100	Very loud classical music
1.5	102	
1	105	Patrice screaming at Ron about deadlines
0.5	110	
0.25 or less	115	Loudest parts at a rock concert

WARNING — To reduce the risk of fire or electric shock, do not expose this appliance to rain or moisture.

This manual covers both the DFX•6 and DFX•12 mixers. They share the same design and operate in the same way, except that the DFX•12 has 2 more mono channels than the DFX•6, and it has 2 stereo line-only channels.



Absolutely most important pages:

Before connecting and using your mixer, please read the **Safety Instructions** on page 2. Before you start mixing, please read the **Quick Start** section starting on page 4. It's a list of steps that will familiarize you with the mixer and help you set up a basic performance.

CONTENTS

SAFETY INSTRUCTIONS	page 2
QUICK START	4
INTRODUCTION	6
APPLICATION DIAGRAMS	7

PATCHBAY FEATURES

MIC	8
LINE IN (MONO)	8
LINE IN (STEREO)	8
INSERT	9
EFFECTS: SERIAL OR PARALLEL?	9
MAIN OUTPUTS	10
PHONES	10
AUX SEND 1/MON	10
AUX SEND 2/EFX	10
AUX 1 RETURN	11
AUX 2 RETURN	11
CD/TAPE INPUT	11
TAPE OUTPUT	11
EFX FOOTSWITCH	11
AC POWER INPUT	11
POWER SWITCH	11

CHANNEL STRIP FEATURES

GAIN	12
LEVEL SET LED	12
LOW CUT	12
2-BAND EQ	12
HI EQ	12
LOW EQ	12
AUXILIARIES	13
AUX 1/MON	13
AUX 2/EFX	13
PAN	13
MUTE	13
FADER	13
OL OVERLOAD LED	13

MASTER SECTION FEATURES

STEREO GRAPHIC EQ	page 14
MAIN/AUX 1 EQ SWITCH	15
BYPASS EQ SWITCH	15
POWER LED	15
PHANTOM POWER SWITCH AND LED ...	15
METERS	15
PHONES LEVEL	15
MAIN MIX FADERS	15
CD/TAPE RETURN FADER AND MUTE ...	15
BREAK SWITCH	16
VOCAL ELIMINATOR SWITCH	16
AUX 2/EFX SEND	16
LEVEL SET LED	16
AUX 2/EFX RETURN FADER AND MUTE ..	17
AUX 1/MON SEND	17
EFFECTS TO MONITOR	17
AUX 1 RETURN FADER AND MUTE	17
EMAC EFFECTS PROCESSOR	17
QUICK START	17
BYPASS LED	17
PRESET SELECTION	18

APPENDIX A: SERVICE INFO

WARRANTY SERVICE	20
TROUBLESHOOTING	20
REPAIR	20

APPENDIX B: TECHNICAL INFO

SPECIFICATIONS	21
DIMENSIONS	22
AC POWER CONSIDERATIONS	22
BLOCK DIAGRAM	23

Please visit our website at www.mackie.com for more information about this and other Mackie products.

QUICK START

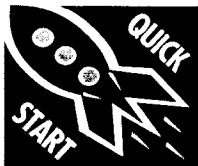

We know you can't wait to get the show on the road. Who has time to read a booooring manual? That's fine — the DFX Mixer is designed to set up quickly and operate intuitively — but please, read the **Safety Instructions** on page 2, and then **read these two pages!**

First you will zero the console, then make the connections, set the levels and tweak the mix.

1. ZERO THE CONSOLE:

1. Turn everything off, including the mixer's POWER switch and PHANTOM POWER switch.
2. Turn down the channel strip GAIN, AUX 1 and AUX 2 knobs, and faders.
3. Center the channel strip EQ and PAN controls.
4. Push the channel strip MUTE switches down.
5. Set the channel strip LOW CUT switches up.
6. Center the STEREO GRAPHIC EQ sliders.
7. Turn down the MASTER AUX SEND knobs, and the AUX RETURN faders.
8. Turn down the MAIN MIX faders.
9. Now you are ready to make the connections, see the next page.

MACKIE® DFX-12
12 CHANNEL INTEGRATED LIVE SOUND MIXER

Zeroing the console

- Control Centered
- Control Fully Down
- Switch UP
- Switch DOWN
- All Faders DOWN

1. Connect your amplifier's outputs to your speaker inputs (unless, of course, you have powered monitors).
2. Plug all the sound system components into suitable AC outlets, properly grounded and capable of delivering adequate current.
3. Using XLR or 1/4" TRS cables, make connections from your mixer's MAIN OUT to your amplification system's line inputs.
4. Make connections from your microphones and instruments to the mixer: Connect balanced microphones to the mono channel MIC jacks. (For condenser microphones, engage the PHANTOM POWER switch, located just above the meters). Connect line-level instruments (synthesizers, guitar effects, direct boxes) to the mono or stereo channel LINE IN 1/4" TRS jacks.
5. ZERO THE CONSOLE as shown on the previous page.
6. Turn all the power switches on, leaving the amplifier's switch for last.
7. Turn up the MAIN MIX faders to the "-30" label, for now. We'll crank it later on.
8. Now you are ready to set the levels:

3. SET THE LEVELS:

1. Choose one of the microphones or instruments you connected. Make some noise. If it's a microphone, sing at your normal singing volume. If it's a synthesizer, play it at its normal output level.
2. While making noise, turn up that channel's GAIN control until the adjacent LEVEL SET LED starts a-blinking.
3. Disengage (up) that channel's MUTE.
4. Raise that channel's fader to unity gain ("U" label). You should be hearing your noise now.
5. If necessary, apply channel EQ changes. (You may need to compensate for level changes with the channel fader.)
6. Check that the channel's OL LED does not come on. If it does, reset the GAIN and adjust the EQ if required.
7. Repeat steps 1 through 6 for the remaining active channels.
8. Stop making noise. Everyone: start making music.
9. Now you are ready to tweak the mix:

1. Engage MUTE on all channels except your rhythm section (drums & bass).
2. Adjust the rhythm section's channel faders to get a good balance of levels.
3. Un-mute the other active channels and adjust their faders.
4. Now that you have a rough mix going, turn up the MAIN MIX faders to a comfortable listening level.
5. If the overall mix has an equalization problem, make adjustments to the STEREO GRAPHIC EQ. If an individual channel is the problem, use its channel EQ instead.
6. Use the channel AUX 2/EFX knobs to send signals to the EMAC internal effects processor (and to any external effects processor you might have). Then adjust the AUX 2/EFX RETURN fader and experiment with adding some effects to your main mix.
7. If you are playing into the CD/TAPE input, try using the VOCAL ELIMINATOR to hear its effect on centered vocals and start up a bit of audience mass-Karaoke.
8. Depending on how much time you've got, keep tweaking. Walk the room to see how it sounds away from your mixer.
Keep tweaking.

KNOW THESE THINGS:



- Never listen to loud music for prolonged periods. Please see "Safety Instructions" on page 2 for information on hearing protection.
- Never plug amplifier outputs into anything except speakers.
- Never use guitar cables to connect amplifiers to speakers.
- Before making connections to an external amp or reconfiguring an amp's routing, turn the amp's level (gain) controls down, turn the power off, make the changes, turn the power back on, and then turn the level controls back up.
- When you shut down your equipment, turn off any external amplifiers first. When powering up, turn on the amplifiers last.
- Change your engine oil every 3,000 miles and rotate your tires for even wear. Dad would be proud of you.
- Save the shipping box and packing material! You may need them someday, and you probably don't want to have to pay for that again.

INTRODUCTION

Thank you for choosing a Mackie Designs DFX™ Mixer! These compact live-sound mixers are designed to meet the sound reinforcement needs of almost any small to medium-sized club, meeting room, sanctuary, or outdoor gathering.

Here's a quick glance at all the features you've acquired:

2 or 4 mono channels, with:

- Variable input gain (0 to +50 dB mic, -20 to +30 dB line)
- Phantom power (globally switched)
- Level Set gain-setting indicator LED
- XLR microphone input jack
- 1/4" TRS line input jack
- 1/4" TRS insert jack
- Switchable 75 Hz low-cut filter
- Pre-fader aux (monitor) send
- Post-fader aux (effects) send
- 2-band EQ
- Pan control
- Mute switch
- Overload warning LED
- 60mm mono fader

2 mono-mic / stereo-line channels, with:

- Variable input gain (0 to +40 dB mic, -20 to +20 dB line)
- Level Set gain-setting indicator LED
- XLR microphone input jack
- Left and Right 1/4" TRS line input jacks
- Pre-fader aux (monitor) send
- Post-fader aux (effects) send
- 2-band EQ
- Pan control
- Mute switch
- Overload warning LED
- 60mm stereo fader

The DFX•12 also includes:

2 stereo-line channels, with:

- Variable input gain (-20 to +20 dB line)
- Level Set gain-setting indicator LED
- Left and Right TRS line input jacks
- Pre-fader aux (monitor) send
- Post-fader aux (effects) send
- 2-band EQ
- Pan control
- Mute switch
- Overload warning LED
- 60mm stereo fader

Comprehensive master section, with:

- Two 60mm main mix faders (L, R)
- Balanced XLR stereo main outputs
- Balanced TRS stereo main outputs
- 12-segment stereo LED metering
- 5-band stereo graphic EQ with main mix/monitor switch and bypass switch
- EMAC™ 32-bit digital stereo effects with footswitch bypass, and Level Set LED
- Aux 1/monitor send with level control
- Aux 2/effects send with level control
- Effects-to-monitor control
- Two 60mm stereo aux return faders with mute switches
- Break switch for intermissions
- RCA Tape output
- RCA CD/Tape input
- Vocal Eliminator circuit for CD/Tape
- Master +48 V phantom power switch with LED indicator
- Headphone output with level control
- Power LED indicator

Please write your serial number here for future reference (i.e., insurance claims, tech support, return authorization, etc.):

Purchased at:

Date of purchase:

APPLICATION DIAGRAMS

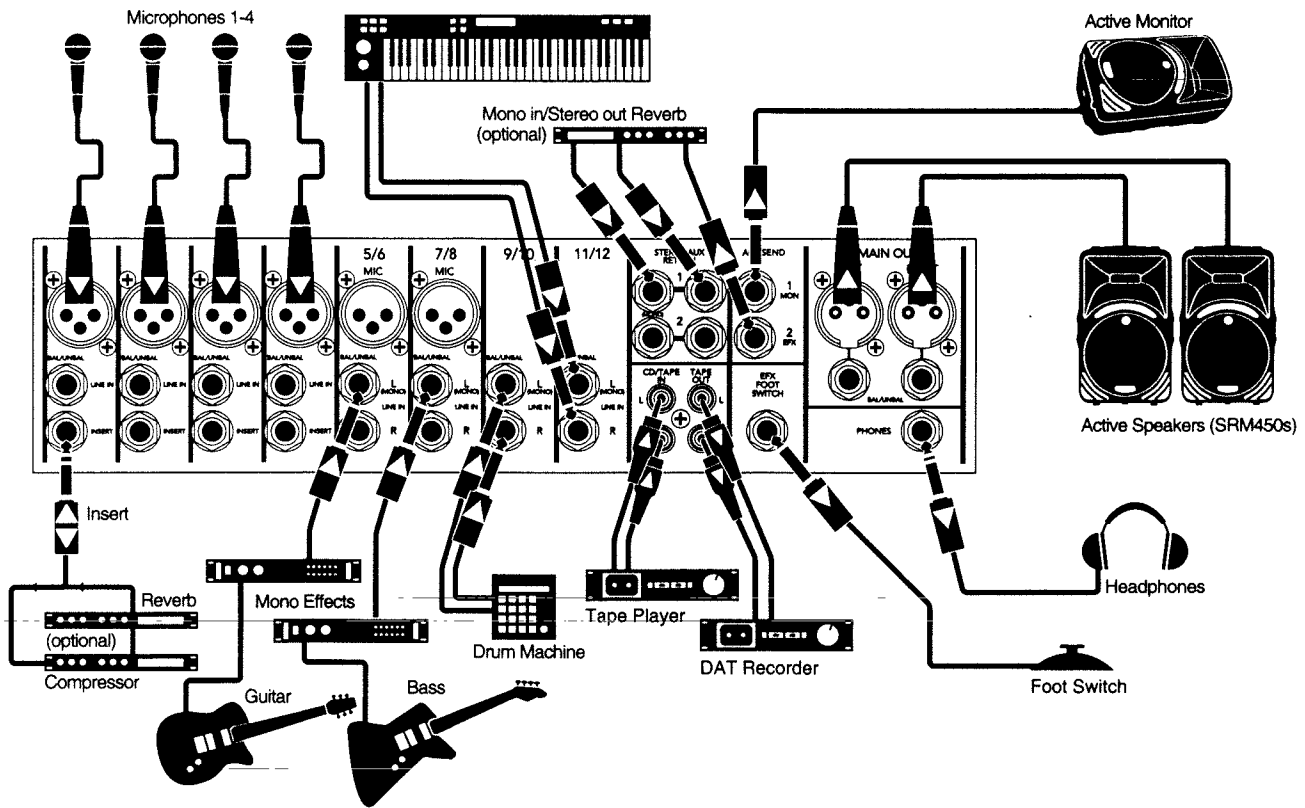

DFX-12 — Small Club Gig

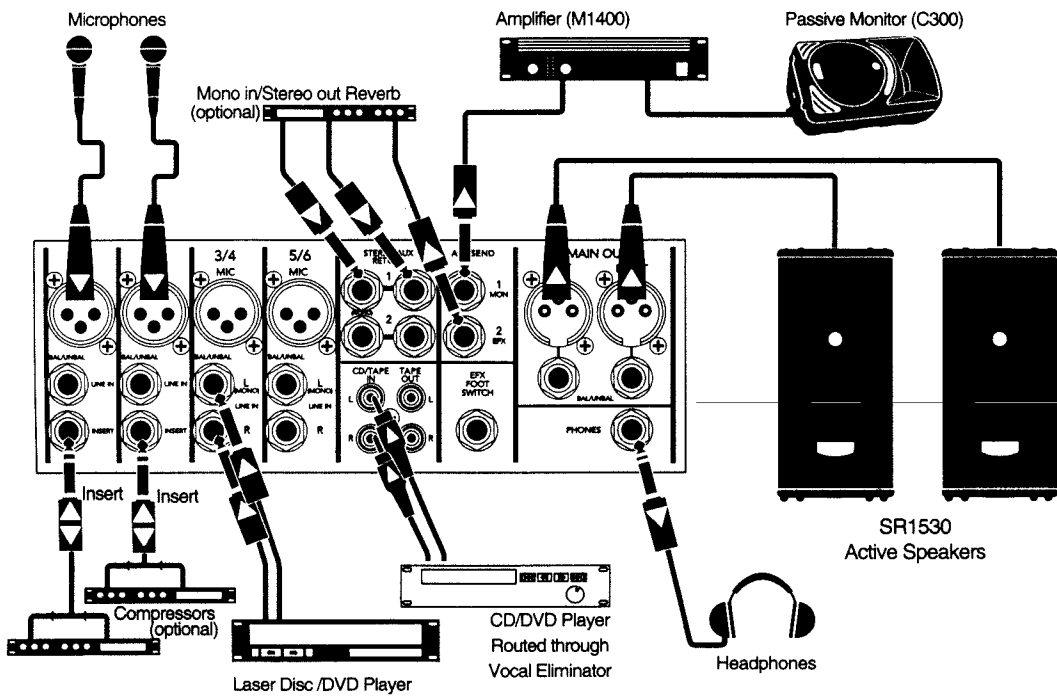

DFX-6 — Karaoke set up

PATCHBAY (the intro and the outro)

This is where everything gets plugged in: microphones, line-level instruments, effects devices, and the ultimate destination(s): PA system, monitors, headphones, and tape recorder, etc.

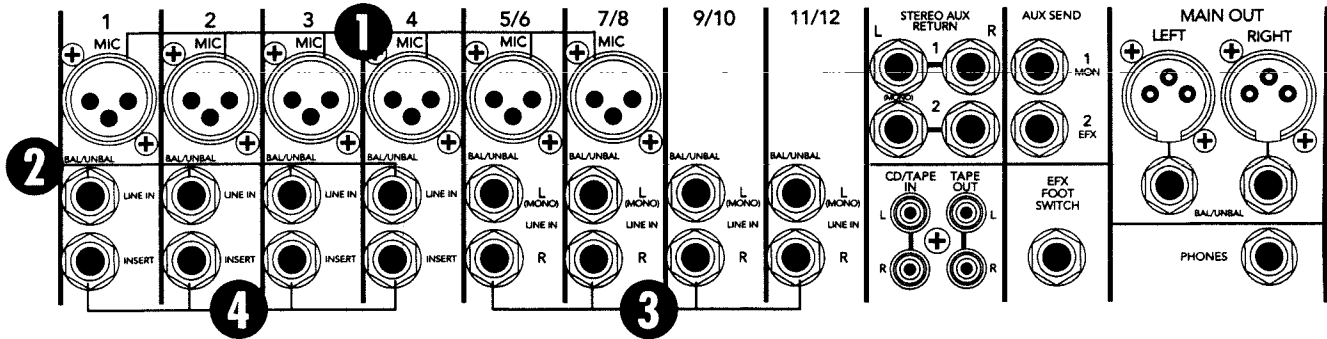

1. MIC

The DFX Mixer is equipped with rugged, low noise, phantom-powered microphone preamplifiers, providing up to 50 dB of pounding crystal-clear amplification. Their balanced circuitry rejects all manner of extraneous interference. Professional condenser, dynamic, and ribbon mics all sound excellent through these XLR inputs.

You can plug in almost any kind of balanced mic that has a standard XLR-type male mic connector.

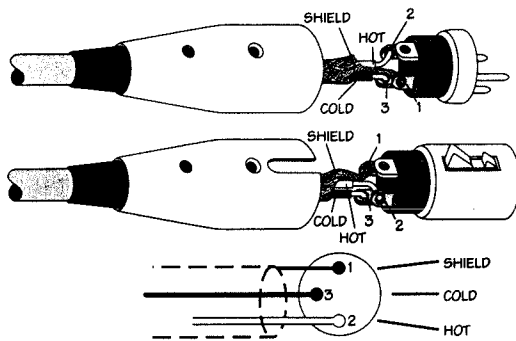

XLR balanced wiring:

- Pin 1 = shield
- Pin 2 = hot (+)
- Pin 3 = cold (-)

The DFX Mixers provide +48 VDC phantom powering on pins 2 and 3 of all the mono channels' XLR MIC inputs (not the stereo channels). This can be turned on or off using the PHANTOM POWER (31) switch on the right side of the mixer.



DO NOT connect a line-level device to a MIC input with the phantom power switched on. This could damage the device. Use the LINE IN (2, 3) jacks instead.

2. LINE IN (FOR MONO CHANNELS)

These inputs can accept 1/4" TRS balanced and 1/4" TS unbalanced plugs from any line-level instrument, effects device, or tape player. The line inputs share circuitry (but not phantom power) with the mic preamps, and can be driven by virtually any line-level signal.

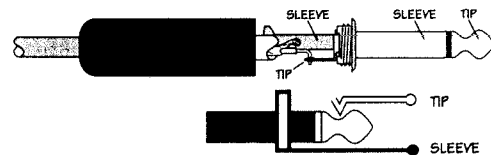

1/4" TS (Tip-Sleeve) unbalanced wiring:

- Tip = hot (+)
- Sleeve = shield

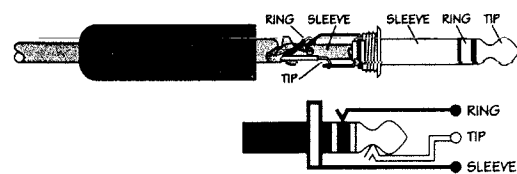

1/4" TRS (Tip-Ring-Sleeve) balanced wiring:

- Tip = hot (+)
- Ring = cold (-)
- Sleeve = shield

3. LINE IN (FOR STEREO CHANNELS)

These inputs can accept 1/4" TRS balanced and 1/4" TS unbalanced plugs from any line-level instrument, effects device, or tape player.

When connecting a stereo device (two cords), use both the left (mono) input and the right input.

When connecting a mono device (just one cord), always use the left (mono) input and plug nothing into the right input. A trick called "jack normalling" causes the signal to appear

Use the insert jacks to send the channel signal through a compressor, graphic equalizer, or similar device.

With nothing plugged into this jack, the channel's signal goes straight through the mic/line preamp and channel strip. With an external effects device plugged into this jack, the channel's signal leaves the mixer, goes through the effects device and back into the channel strip (see insert plug diagram below).

The insert send signal is not affected by the channel EQ or fader, thereby preserving the original signal's characteristics. Only the GAIN (16) control has any effect on the insert send level.

Specialty cables, developed just for these insert jacks, are widely available. They allow a signal to leave and enter the mixer on the same TRS plug. They are wired thuswise:

Tip = Send (to effects device input)
 Ring = Return (from effects device output)
 Sleeve = Common ground (connect shield to all three sleeves)

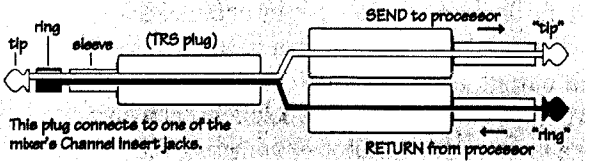

Besides being used for inserting effects devices, these jacks can also be used as channel direct outputs; post-GAIN (16), pre-LOW CUT (18) and pre-EQ (19, 20).

Here are three ways to use the jacks:

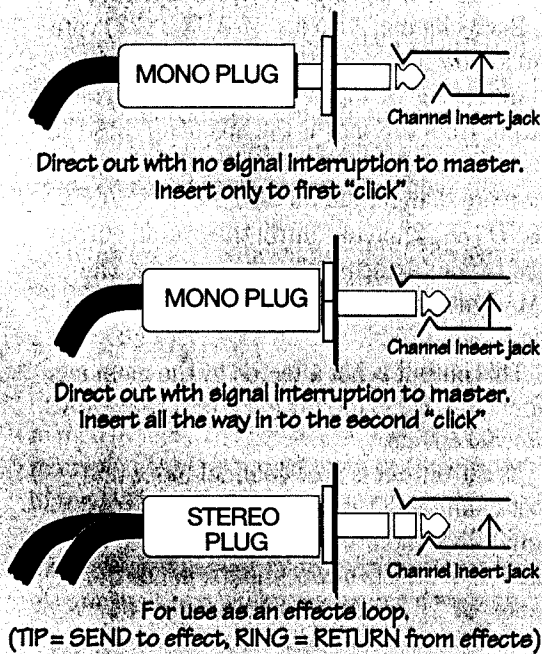

Effects devices are used either in serial or in parallel:

Serial means that the entire signal is routed through the effects device. Examples include: preamps, compressor/limiters, graphic equalizers. Connections are typically made via the channel INSERT jacks.

Parallel means that a portion of the signal is tapped off to the effects device, processed, and returned, to be mixed with the original "dry" signals. Multiple signals (via multiple mixer channels) can all make use of the same parallel effects device. Examples include: reverb, delay, chorus. Connections are typically made via AUX sends and AUX returns.

Serial Device

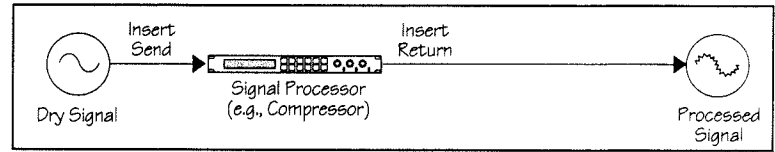

Parallel Device

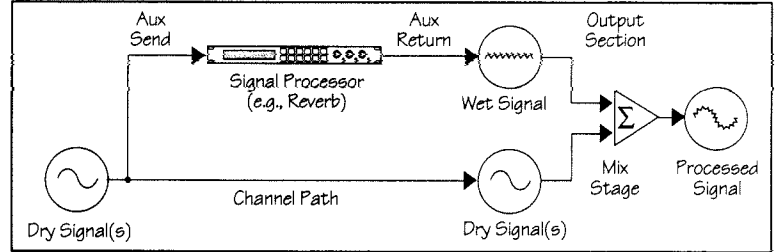

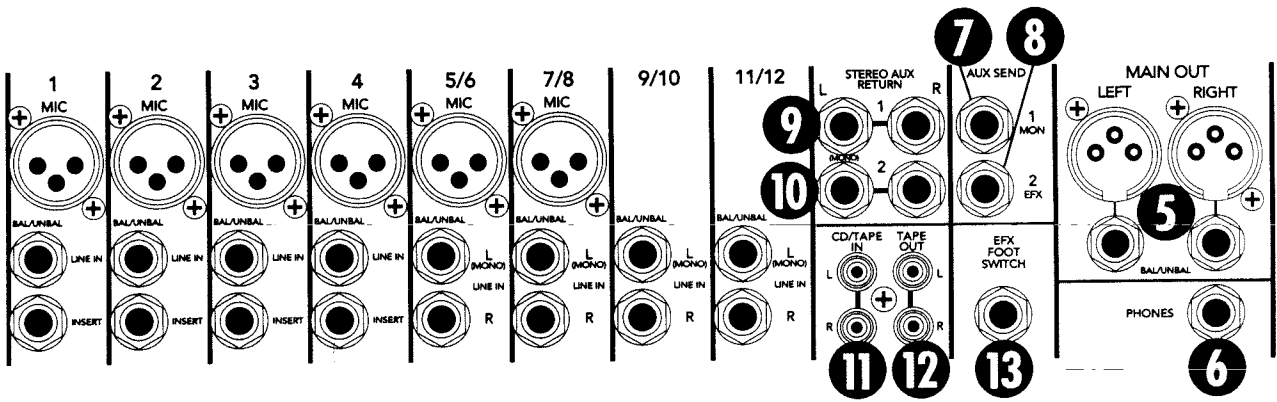

5. MAIN OUTPUTS

Coming in two flavors, XLR and 1/4" TRS, the main output represents the end of the mixer chain, where your fully mixed and enhanced stereo signal enters the real world.

Connect these outputs to the inputs of your amplifier, or powered speakers.

XLR balanced wiring:

- Pin 1 = shield
- Pin 2 = hot (+),
- Pin 3 = cold (-)

1/4" TRS balanced wiring:

- Tip = hot (+)
- Ring = cold (-)
- Sleeve = shield

6. PHONES OUTPUT

The stereo signal at this output jack is the main mix, but it is not affected by the position of the MAIN MIX (34) faders.

The PHONES (33) control knob allows you to set the levels in your headphones as desired, without disturbing the main mix level.

Note: Be very careful because the PHONES jack can drive any standard headphones to very loud levels. Please see the "Safety Instructions" on page 2 for information on hearing protection.

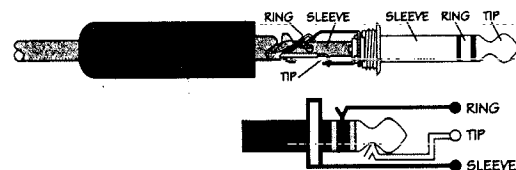

1/4" TRS stereo wiring:

Tip = left, ring = right, sleeve = shield

Walkperson-type phones can also be used with an appropriate adapter.

7. AUX SEND 1 / MON OUTPUT

To create a stage monitor mix, patch this TRS output into your monitor amplifier's input, or powered monitor's input. This jack can also be used to feed the inputs of an effects device.

Each channel strip has an AUX 1 (21) control knob which adjusts how much of that channel's signal appears at this output. The output from this jack is the sum of all those active channels which have their AUX 1 knobs set more than in the minimum position. Use the AUX 1/MON SEND (41) knob (page 17) to control the overall output sent to your monitor.

The output is not affected by the main mix faders, or channel faders, or by channel EQ.

The five band EQ (27) can be applied to this output using the MAIN/AUX 1 (28) switch. A sample of the stereo effects can also be added to your monitor by adjusting the EFFECTS TO MONITOR (42) knob.

See AUX 1/MON (21) on page 13 for more information.

8. AUX SEND 2 / EFX OUTPUT

This 1/4" TRS output can be used to connect to the input of an external effects device.

Each channel strip has an AUX 2 (22) control knob which adjusts how much of that channel's signal appears at this output. The output from this jack is the mix of all those active channels which have their AUX-2 knobs set more than minimum. Use the AUX 2/EFX SEND (38) knob to control the overall output sent to your external effects processor. The EMAC-internal effects processor receives the same signal.

This output is not affected by the main mix faders, the five-band EQ (27), or by the EMAC-internal effects.

As the output is post-channel-fader, and post-channel EQ, it cannot be used as traditional stage monitor cues. It is intended to patch into effects device inputs; hence the name "EFX." See AUX 2/EFX on page 13.

7. AUX 1 RETURN INPUTS

Patch the outputs of external parallel effects devices to these inputs.

Signals coming in are adjusted using the AUX 1 RETURN (43) fader and MUTE.

When connecting a mono device (just one cord), always use the left (mono) input and plug nothing into the right input. The signal will appear on both sides.

10. AUX 2 RETURN INPUTS

Patch the outputs of external parallel effects devices to these inputs.

Signals coming in are adjusted using the AUX 2 RETURN (40) fader and MUTE.

When connecting a mono device (just one cord), always use the left (mono) input and plug nothing into the right input. The signal will appear on both sides.

Note: The AUX 2 RETURN signal is combined with the signal from the internal effects processor.

11. CD/TAPE INPUT

Patch the outputs of your intermission entertainment here. Any line-level mono or stereo device can be used: tape, DVD/CD player, television audio, etc.

Signals coming into the CD/TAPE (11) inputs are adjusted using the CD/TAPE RETURN (35) fader and MUTE.

Also see page 16 for information regarding the BREAK (36) switch.



RCA unbalanced wiring:

Tip = hot, sleeve = shield

When connecting a mono device (just one cord), you'll need a "Y-splitter" RCA adapter. It turns a mono output cord into two cords; so both the left and right tape input jacks can be used. This adapter is widely available.

Note: There is a chance of feedback if you have the ins and outs connected to the same recorder, and it is in record mode.

12. TAPE OUTPUT

Use these jacks to capture the entire performance to tape. The signal at these jacks is the main mix, but it is not affected by the position of the MAIN MIX (34) faders.

If you find that the output to tape is quite low in level, but your main speaker sound levels are good, you might try turning down the

the channel faders upwards to compensate. This will increase the levels in the mixer and the tape output.

13. EFX FOOTSWITCH

You can connect a normally-open footswitch here to switch the EMAC effects processor in and out. Closing the switch connection causes the internal effects to be bypassed, as you bask in the warm glow of the BYPASS LED (44).

Note: This only affects the internal effects and does not affect any signals from devices plugged into AUX 1 and AUX 2 returns.

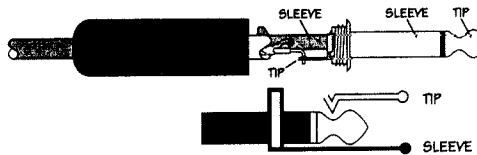

1/4" TS (Tip-Sleeve) Footswitch wiring:

Tip = one end of a normally-open switch

Sleeve = shield, and other end of a normally-open switch.

14. AC POWER INPUT

This IEC socket on the rear panel, is where you connect the supplied AC linecord to provide AC power to the mixer. Plug the cord into a suitable AC outlet, properly grounded and capable of delivering adequate current.

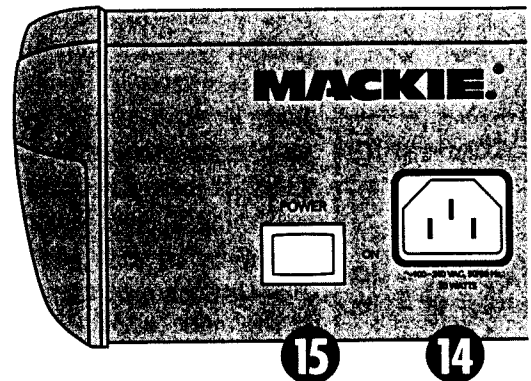

The mixer has a universal-input, switching power supply, so you can plug the AC linecord into any AC outlet with a voltage between 100 and 240 VAC, without having to worry about setting any switches or using a step-up or step-down voltage transformer.

15. POWER SWITCH

Push the side of the switch labeled "ON" to turn the mixer on; you should see the POWER LED (30) glow in confirmation on the top right of the mixer. To turn the mixer off, push the switch the other way.

As a general rule, turn the mixer on first, before any amplifiers or powered speakers, and at the end of a show, turn it off last. This will prevent any turn-on or turn-off thumps being heard in your speakers.

CHANNEL STRIP FEATURES

OVERVIEW

The channel strips are independent of each other, and allow you to adjust, tweak and otherwise beautify the sound coming from your different microphones, guitars and other instruments. The Faders and Pans let you adjust how much of each channel is sent to the main mix. The Auxes let you adjust how much of each channel goes to your stage monitors or out to external or internal effects.

The channel strips come in two flavors: Mono and Stereo. In addition, the DFX•12 has two line-level-only stereo channels.

16. GAIN

If you haven't already, please read "SET THE LEVELS" on page 5.

The GAIN control adjusts the input sensitivity of the mic and line inputs on each channel. This allows signals from the outside world to be adjusted to optimal internal operating levels.

Through the mono channel MIC (XLR) inputs, there is 50 dB of gain fully up. For stereo channel MIC inputs, this is +40 dB.

Through the mono channel LINE IN (TRS) inputs, there is 20 dB of attenuation fully down and +30 dB of gain fully up, with a "U" (unity gain) mark halfway up. The stereo channel LINE INs have a maximum gain of +20 dB.

Having 20 dB of line-level attenuation can be very handy when you are injecting a signal that is very hot, or when you want to add a lot of EQ boost, or both. Without this "pad," it would be very difficult to control the line signal and might lead to channel clipping.

17. LEVEL SET LED

This LED (Light Emitting Dohickey) lets you know that the signals going into the mixer are adjusted to the correct level, not too strong to cause distortion and not too weak to be lost in noise.

After you connect a microphone or line-level component to the mixer, do a sound test and adjust the GAIN (16) control until this handy LED flickers just occasionally. If it is glowing constantly, turn the GAIN down. If the LED is doing almost nothing, turn it up.

18. LOW CUT

The LOW CUT circuit, often referred to as a high-pass filter, cuts the bass frequencies below 75 Hz at a rate of 18 dB per octave.

We recommend that you use LOW CUT on every microphone application except kick drum, bass guitar, or bass-heavy synth patches. LOW CUT can also help reduce the possibility of feedback in live situations and it helps to conserve amplifier power.

2-BAND CHANNEL EQ

The DFX Mixers use "shelving" equalization. This boosts or cuts all frequencies past a specified frequency. For example, turning the LOW EQ (20) knob clockwise will boost the bass frequencies at 80 Hz and below.

Although you can bring sound to life with proper EQ, you can also mess things up. If you max the EQs on every channel, you'll get mix mush, not to mention driving your mix levels near or beyond clipping. So equalize subtly; use cut as well as boost.

Adjusting the channel EQ will affect your main mix and the AUX 2/EFX (8) output, but not the AUX 1/MON (7) output.

19. HI EQ

This control provides up to 15 dB of boost, or 15 dB of cut at 12 kHz and above. There is no boost or cut at the center detent position.

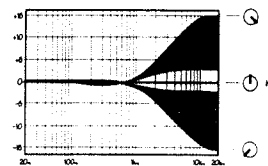

Use this wisely to add sizzle to cymbals or an overall sense of transparency or edge to keyboards, vocals, guitar, and bacon frying. Turn it down a little to reduce sibilance or hide tape hiss.

20. LOW EQ

This control provides up to 15 dB of boost, or 15 dB of cut at 80 Hz and below.

There is no boost or cut at the center detent position. Frequencies of 80 Hz and below represents the punch in bass drums, bass guitar, fat synth patches, and high-testosterone male singers.

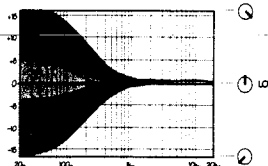

While adding boost, also engaging the LOW CUT (18) switch can create an audible low frequency boost without boosting stage rumble, mic-handling clunks, and breath pops.

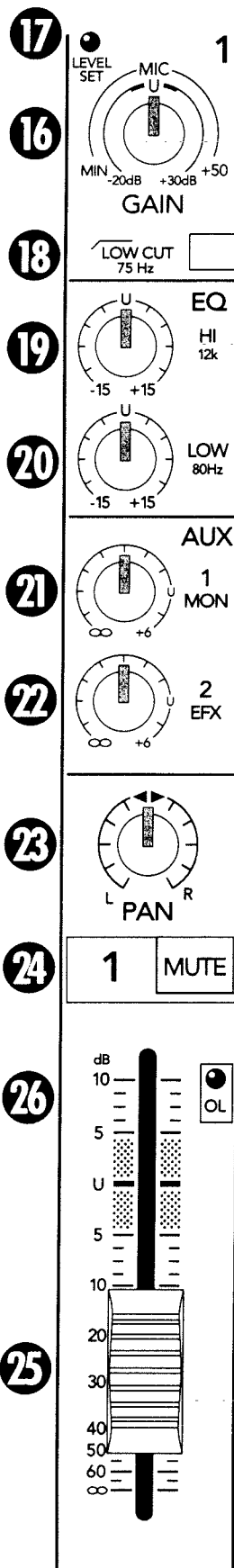

Mono Channel

AUX 1/MON allows you to create a separate mono mix which can be used to feed stage monitors.

AUX 2/EFX allows you to create another mono mix to feed the EMAC internal effects, and any external effects processor you have.

The channel AUX knobs adjust how much of each channel is added to each aux mix. The adjustment ranges from off, through unity, and on up to 6 dB of extra gain.

The stereo channel AUX knobs control a mono sum of the channel's stereo signals. For example, on the DFX•12, channel 9 (L) and 10 (R) mix together to feed that the channel 9/10 AUX knobs.

The master AUX SEND (38, 41) knobs adjust the overall aux output levels.

These are more than mere effects and monitor sends: they can be used to generate separate mixes for recording or "mix-minuses" for broadcast.

21. AUX 1/MON

AUX 1 is designed for feeding a separate monitor mix to the musicians on stage, via the AUX 1 SEND (7) output jack.

The signal is tapped off before the channel EQ section, and before the channel fader. Only the channel GAIN, MUTE and LOW CUT will affect the output to your monitors.

22. AUX 2/EFX

AUX 2 is designed for feeding the EMAC internal effects processor and the inputs of parallel effects devices.

It is post-fader, so any changes to the channel controls will affect the AUX 2 signal. In addition to feeding the inputs of the EMAC, it also feeds the AUX 2 SEND (8) output.

23. PAN

This adjusts how much of the channel signal is playing in the left side of the main mix, and how much is playing in the right.

For mono channels, if the PAN control is in the center position, the mono signal appears equally in both the left and right of the main mix. If the control is set left, more of the signal appears in the left side of the main mix. If the control is set right, more of the signal appears in the right side of the mix.

For stereo channels, the PAN control works like the balance control on your home stereo, by attenuating one side or the other. If it is in

signals pass through to the main mix unaffected. If PAN is turned left, the right channel is attenuated; if turned right, the left side is attenuated.

24. MUTE

When you engage a channel's MUTE switch, its signal disappears from the main mix, tape, AUX 1, AUX 2 and headphones. The only exception is the INSERT (4) outputs.

25. FADER

This fader is the master level control for the channel's signal. Subtle adjustment of the channels' fader positions is the key to a finely-tuned mix.

Typically (providing the GAIN (16) control is set correctly) the fader position will be positioned somewhere between 0 dB ("U") and -30 dB.

If you have a fader set all the way up, that's usually a sign that your GAIN is set too low. Conversely, if the fader is set way down, your GAIN may be set too high.



"U" = UNITY GAIN

Mackie mixers have a "U" mark on almost every level control. This stands for "unity gain," meaning there is no change in signal level. Once you have adjusted the input signal to line-level, you can set every control at "U" and your signals will travel through the mixer at optimal levels. What's more, all the labels on our level controls are measured in dog biscuits (dB), so you'll know what you're doing level-wise if you choose to change a control's settings.

26. OL (OVERLOAD) LED

This handy feature gives you the chance to take care of any signal overload before it is made worse by turning up the fader.

This LED only lights when the channel's signals are set too high and are about to distort (clip). The OL circuit monitors the signal just before it reaches the channel fader, so any overload must be taken care of by adjusting the channel's GAIN, EQ, or the LOW CUT, and not the channel fader.

If the LED comes on, make sure you reset the GAIN control correctly, and check that your channel EQ settings are not too high.

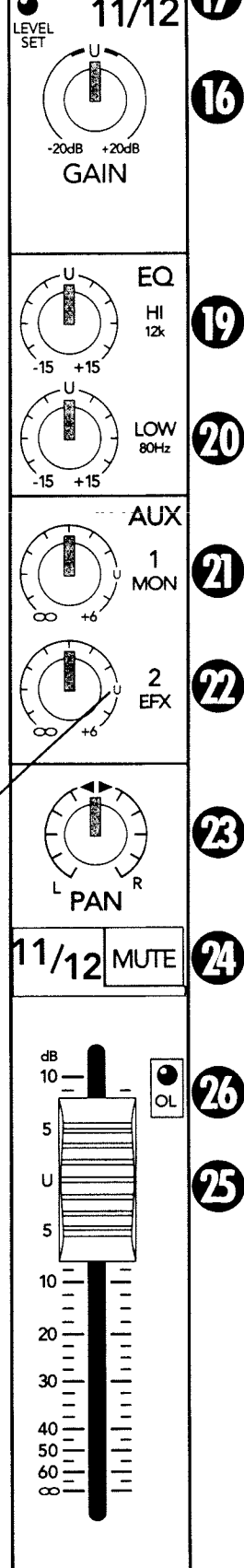

Stereo Channel (DFX•12)

MASTER SECTION FEATURES

MACKIE® DFX-12

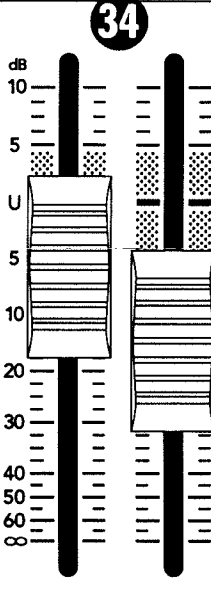
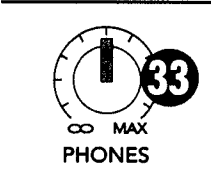
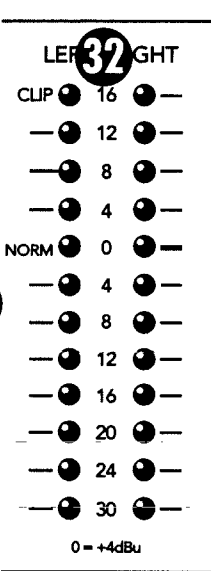
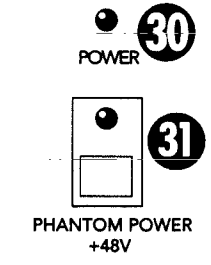
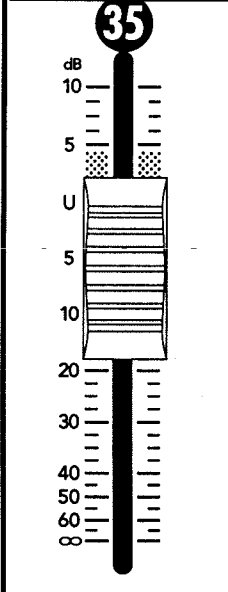
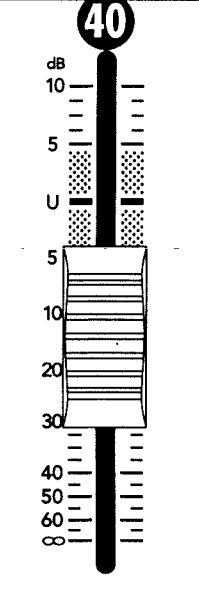
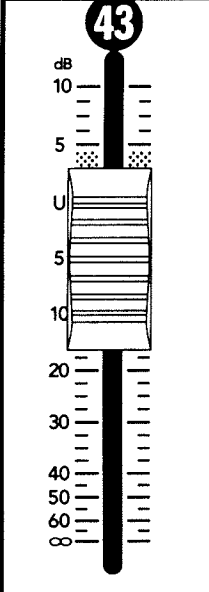
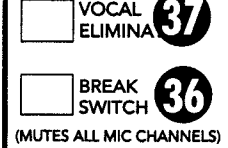
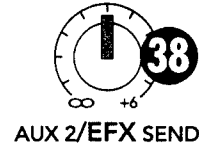
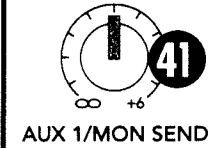
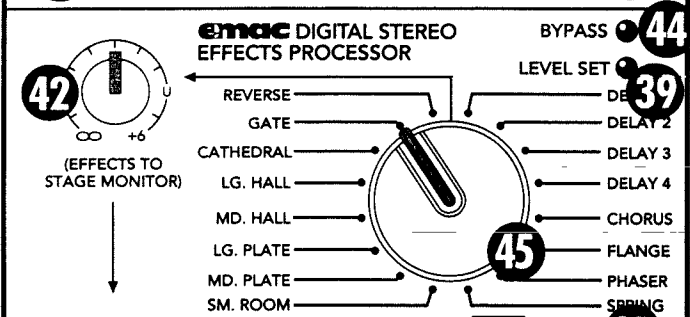
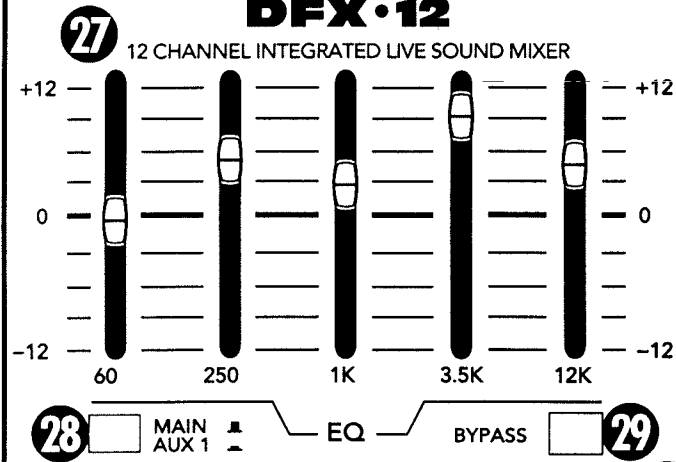

Before you read this chapter, you might want to look at the rather lovely channel strip features on the previous page.

27. STEREO GRAPHIC EQ

This equalizer is used to shape the frequency spectrum of the main mix or monitor mix. It is the last thing in the signal chain before the MAIN MIX (34) faders and the MAIN OUT (5) jacks.

Each EQ slider controls a different section of the audio frequency range. Moving a slider up or down will boost or cut the output levels of signals around the slider's center frequency. By setting all the EQ sliders to zero (center) you'll effectively remove it from the signal path.

The following steps show how the equalizer can be used to reduce feedback:

1. Set the EQ sliders to zero (center) while the band plays on.
2. Set the channel GAIN (16) levels, using the LEVEL SET LED (17) and adjust the channel faders for a nice mix.
3. Slowly turn up the MAIN MIX (34) faders until feedback just begins to occur. BE CAREFUL! Feedback can occur quickly and become very LOUD, very fast.
4. Cut the appropriate EQ slider until the feedback stops.

Here are some general suggestions on using the EQ:

For better vocal sound, set the 250, and 12K sliders to +5. Note: Make sure the singer is within 3 to 6 inches of the microphone. No amount of EQ can save a wandering minstrel.

For more presence, set the 3.5K slider to +5.

To warm up the overall sound, set the 1K slider to -5.

REMEMBER, LESS IS BETTER.

28. MAIN/AUX 1 EQ SWITCH

This switch allows you to add EQ either to your main mix, or to your monitors.

In the UP (MAIN) position, the EQ (27) only affects the main mix, phone or tape outs.

In the DOWN (AUX 1) position, the EQ only affects the AUX SEND 1/MON (7) output; with no effect on the main mix, phone or tape outs.

29. BYPASS EQ SWITCH

Use this switch to quickly compare the effect of your EQ settings.

In the UP position, the EQ (27) section is in line with the signal path, (either main mix or monitor, depending on the position of the MAIN/AUX 1 (28) switch).

In the DOWN position, the EQ section is bypassed and has no effect on any outputs.

30. POWER LED

This LED turns on when the mixer is switched on, and (as you can probably guess) it turns off when the mixer is switched off.

31. PHANTOM POWER SWITCH and LED

Press this switch to turn on the pretty LED. It also supplies phantom power to all of the mono channels' XLR MIC inputs. Phantom power is required to operate most condenser microphones (some condenser microphones are battery-powered). With the switch pressed in, the DFX Mixers provide +48 VDC phantom powering on pins 2 and 3 of the XLR connectors.

Note: The stereo channels do not have phantom power on their XLR connectors.

If you have dynamic, ribbon, or tube mics that do not require phantom power, leave the switch out. If you are using both condenser and dynamic mics, don't worry. Phantom power will not hurt most dynamic mics. Check the microphone's user manual if you're not sure.



Caution: Turn all output levels down before operating this switch to avoid the possibility of a "pop" in your speakers.

32. METERS

The DFX Mixer's metering system is made up of two columns of twelve LEDs each, with thresholds ranging from -30 dB up to "CLIP."

The 0 dB LEDs correspond to an output level of +4 dBu (=1.23 V). The "CLIP" LEDs turn on when the output reaches +20 dBu. There is a fair margin of safety before actual clipping distortion occurs, but you should turn things down if you see it come on.

mix, after the MAIN MIX (34) faders.

You can get a good mix with the meter's peaks flashing anywhere between -20 and +8 dB. Most amplifiers clip at about +10 dB, and some recorders aren't so forgiving either. For best real-world results, try to keep your peaks between "0" and "+8."

If your meters are too high, you will get distortion. If they are too low, then your signal/noise will suffer. Use the meters to help you adjust the mixer for optimum performance without distortion or noise, then you can adjust your amplifiers for good overall volume.

33. PHONES

This control allows you to adjust the headphone levels without disturbing the main mix.

Turn this down before connecting and putting on your headphones. Bring it up slowly.

Please see the "Safety Instructions" on page 2 for information on hearing protection.

34. MAIN MIX FADERS

These two faders control the final level of the signals sent to the MAIN (5) outputs.

The TAPE (12) and PHONE (6) outputs also receive the main mix, but are not affected by these faders.

All active mono and stereo channels that are not turned fully down will appear in the main mix. Other signals feeding these faders include: AUX 1 RETURN(9), AUX 2 RETURN (10) including the EMAC internal effects, and the CD/TAPE (11) inputs.

The faders, set fully up, provide 10 dB of gain. A "U" unity gain point is just below that. When set fully down, the main mix is effectively muted. These are the faders to pull down at the end of the song when you want The Great Fade-Out.

35. CD/TAPE RETURN FADER and MUTE

If you have a CD or Tape player connected to the CD/TAPE (11) inputs, the signals pass through the MUTE switch, through this stereo fader, and then into your main mix. This is like a channel fader, except it is adding the CD/TAPE input to the main mix, instead of adding a channel.

Set this fader to minimum, then play your selection and increase the fader as desired. Assuming the MAIN MIX (34) faders are set, you should hear the music. Press down the VOCAL ELIMINATOR (37) if you like to remove centered vocals, and BREAK (36) if you want to play soothing CDs or tapes while the band is breaking up the bar.

MACKIE®

DFX•12

27 12 CHANNEL INTEGRATED LIVE SOUND MIXER

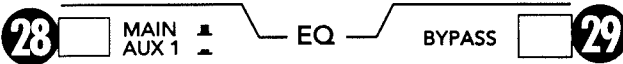
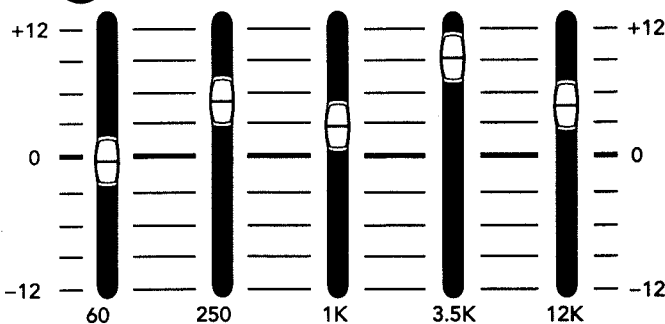

28 MAIN AUX 1 EQ BYPASS 29

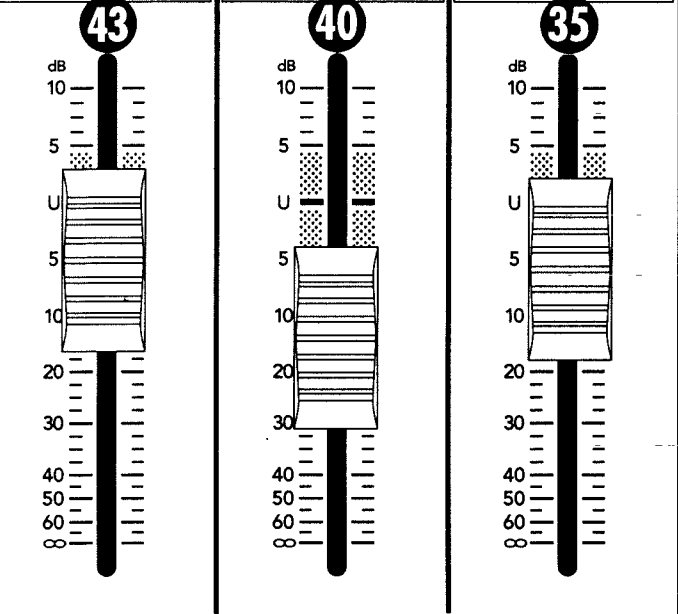
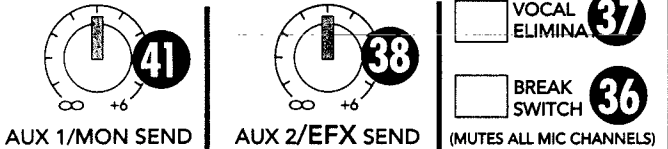
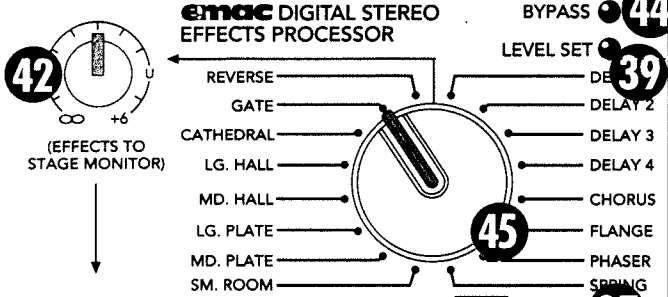

36. BREAK SWITCH

Engage the BREAK switch (as in take-a-break) and the entire main microphone mix is switched off.

The CD/TAPE (11) input is still active, so you can play your intermission CDs or tapes through the main outputs. On the DFX•12, line level inputs 9 and 10, 11 and 12 are also still active, and are summed with the CD/TAPE input. During an intermission, you could play keyboards or a second tape deck into these line inputs.

BREAK acts as a master mute switch for your microphones, so it is useful when moving microphones around on stage. It does not mute the AUX 1 (7) or AUX 2 (8) outputs, so turn down the master AUX SEND (41, 38) knobs if desired.

37. VOCAL ELIMINATOR SWITCH

This switch allows you to eliminate the vocals from any CD or Tape selection playing in the CD/TAPE (11) inputs.

In the UP position, the CD or Tape signals are not affected. In the DOWN position, any vocals which are centered in the normal stereo image will be attenuated.

The circuit design uses phase cancellation of the vocal frequency range between the left and right channels. The effect is most noticeable on music material which has the vocals panned dead center.

38. AUX 2/EFX SEND

Effects send signals are derived by each channel's AUX 2/EFX (22) control, summed together, then sent through this master control. It allows you to simultaneously adjust the signal levels out to the AUX 2/EFX SEND (8) output, and to the EMAC effects processor.

Turned fully up, it provides 6 dB of gain, "U" is unity gain, and fully down is off.

Use the individual channel AUX 2/EFX controls to adjust the amount of each channel's signal you want to go to the AUX 2/EFX SEND or EMAC. Then use this master control to make sure the EMAC's LEVEL SET LED (39) never lights more than occasionally.

39. LEVEL SET LED

This indicates when the EMAC is 6 dB below clipping. Just like the channel LEVEL SET LEDs (17), this should only light occasionally. If it blinks frequently, you should turn down the AUX 2/EFX SEND (38) control a little. If this LED never blinks, then turn the control up.

The EMAC output is added to any signals going into the AUX 2 RETURN (10) jacks from an external effects processor. The final effects signal is then sent to this MUTE switch and stereo fader. It acts like a channel fader, except it is adding the final effects signal to the main mix, rather than adding a channel signal.

Turned fully up, it provides 10 dB of gain, "U" is unity gain, and fully down is off.

Press MUTE to quickly compare the difference between adding, or not adding effects. The MUTE and fader affect the level of the effects going to the main mix only, and not of any effects going to the monitors.

41. AUX 1/MON SEND

This allows you to control the level of the signal going out to your monitors.

Any signals from each channel's AUX 1/MON (21) control (and the EFFECTS TO MONITOR (42) control), are summed together, then sent through this master control.

Turned fully up, it provides 6 dB of gain, "U" is unity gain, and fully down is off.

When the talent wants a louder monitor mix, this is the control to crank up — watch out for feedback!

42. EFFECTS TO MONITOR

Typically, this control is used to add effects to the stage monitors. Any effects sent to the monitors are the same as in the main mix, except for the level, and they are summed mono. The effects level sent to the monitor mix is not affected by the AUX 2/EFX RETURN (40) fader, so the monitors and main mix effect levels can be set independently.

Turned fully up, this control provides 6 dB of gain, and "U" is unity gain. Turn it fully down for no effects sent to your monitors.

This control is similar to each channel's AUX 1/MON (21) control, except it adds the effects (summed mono) to the monitor mix, rather than adding a channel signal.

43. AUX 1 RETURN FADER and MUTE

Any signals going into the AUX 1 RETURN (9) jacks from an external processor pass through the MUTE switch and then to this stereo fader. This is like a channel fader, except it is adding the signal from an external device to the main mix, rather than adding a channel signal. Turned fully up, it provides 10 dB of gain, "U" is unity gain, and fully down is off.

EMAC stands for Extended Multiply and Accumulate, which is a proprietary 32-bit digital stereo processor developed by our Digital Engineering Group. It provides you with a choice of 16 preset digital effects algorithms for your enjoyment.

The mono signal going into the EMAC comes from the AUX 2/EFX (22) controls of each channel, summed together and passed through the AUX 2/EFX SEND (38) control. Note that the AUX 2/EFX signals are post-channel EQ and post-channel fader, so any channel adjustments will alter the effects.

The EMAC takes the mono input, processes it and creates a stereo output. A footswitch allows the EMAC to be bypassed and a SET LEVEL LED (39) allows the input signal strength to be optimized for best performance.

The processed stereo signals coming out of the EMAC are added to any signals coming in from an external processor connected to the AUX 2 RETURN (10) jacks. The combined signals then pass through the MUTE (40) and AUX 2/EFX RETURN (40) fader and then on to the main mix.

EMAC QUICK START

Assuming you have your basic mix up and running, turn up the AUX 2/EFX (22) controls on each channel. This feeds individual amounts of channel signals to the EMAC.

Set the master AUX 2/EFX SEND (38) control so the EMAC's LEVEL SET LED (39) blinks occasionally.

Turn up the AUX 2/EFX (40) fader and you should be hearing the effects.

Next, goof around with the various Preset Selects (45) to listen to their effect. When you find an effect you like, jot it down, then goof around some more.

To bypass these effects, engage an optional foot switch connected to EFX FOOT SWITCH (13). To send these effects to the stage monitors, turn up the EFFECTS TO MONITOR (42) knob.

44. BYPASS LED

This LED will come on when the EMAC circuit is bypassed by use of an external footswitch. The bypass affects only the internal EMAC effects, not any external effects processor you may have connected to the AUX 2 RETURN (10) jacks.

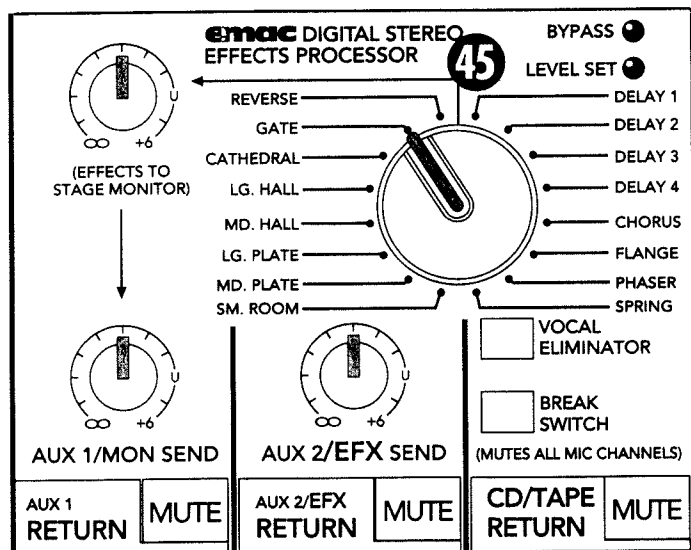

45. PRESET SELECT

Rotate this detented switch to select any of the following preset effects:

REVERBS

The reverbs are designed to provide a wide variety of reverb sounds for vocal and instrument applications. In the following description, "tail" refers to the reflections that follow the initial sound event, also referred to as decay range. "Pre-delay" is the amount of time between the initial sound event and the first reflection.

REVERSE:

Standard reverse reverb, simulating a tail-first effect increasing to the original note.

GATED:

Standard gated reverb, where the reverb tail is cut off sharply after the preset decay length.

CATHEDRAL:

Dense, smooth reverb with very long tail, long pre-delay, and late reflections. Tails are very warm with some additional high-end reflections imitating the stone walls of a cathedral. A very dramatic effect that works well with wind instruments such as flute, slow finger picking on acoustic guitar, and quiet vocal group harmony and choirs. Also works well with keyboards.

LG. HALL:

Dense, smooth reverb with long tail, long pre-delay, and some early reflections. Tails are warm with more apparent high end. Works well with vocals and electric and acoustic guitar.

MD. HALL:

Dense, smooth reverb with normal tail, normal pre-delay, and increased early reflections. Tails are warm with more apparent high end. Works well with vocals and electric and acoustic guitar.

LG. PLATE:

Good early reflections and no pre-delay. Tails are normal and warm with strong high end for increased presence. Perfect for vocals and snare.

MD. PLATE:

Good early reflections and no pre-delay. Tails are short and warm with strong high end for increased presence. Perfect for tight vocals and snare.

SM. ROOM:

Reverb featuring very fast and scattered early reflections with a short pre-delay. Tails are very short and warm with normal high-end imitating absorbent wall materials and audience. Good for tight vocal effects.

SPRING:

Mimics the vintage 60's-style wet spring reverb effect. Tails are normal with strong high end and a slight waver imitating the slow flutter of the mechanical spring system. Very good with acoustic guitar.

DELAYS

There are four delays available with one, two, three, and four repeats:

DELAY 1:

One repeat. Works best for slapback delay used in country and swing guitar, and for rockabilly and some country vocals.

DELAY 2:

Two repeats. Provides a fuller, more dramatic effect for rock and gospel vocals, acoustic guitar, and wind instruments such as flute. Especially effective for some finger-picking styles.

DELAY 3:

Three repeats. An excellent delay for slow, bluesy vocals and melodic flute music. This delay usually works best when the channel EFX send is set at less than halfway.

DELAY 4:

Four repeats. This is for very dramatic delay effects, particularly for enhancing long vocal notes and dramatic instrumental note-chopping effects. Be sure to set the channel EFX send at about halfway.

These include Chorus, Flange, and Phaser, and are generally used for enhancement of instrumental music. However, Chorus adds a dramatic effect to vocals as well.

CHORUS:

Provides a soft, ethereal sweeping effect. Perfect for enhancement of electric and acoustic guitar and bass. It also adds a dramatic effect to vocals, particularly group harmonies and choirs. The channel's AUX 2/EFX should be set half-way or higher.

FLANGE:

Creates a strong sweeping effect, particularly effective on rock electric guitar, lead and rhythm. The channel's AUX 2/EFX should be set halfway or higher.

PHASER:

This effect is perfect for enhancing strummed acoustic guitar or electric guitar power chords. The PHASER effectively duplicates the popular 70's phase shift effect used for guitar.

The following effect ideas did not quite make the grade:

ELEVATOR:

Each musical selection is carefully stripped of its lyrics, passed through a true mono, house band simulator and emerges as a piece even its own songwriter would not recognize or sue you for. The intermingled "bing" at each floor, will have you facing the walls, looking up at the ceiling, and avoiding all eye contact in your own living room.

DAD:

When musical passages increase in volume, they reach a certain trigger point (dad-threshold) at which point, irate male vocals containing the words: "turn it down!" can be faintly heard coming from downstairs, even if you don't have a downstairs, followed by the sound of a broom handle banging on the virtual ceiling. Additional settings include the terms: "if I have to come up there!" and "you long haired hippy!" complete this sound effect suite.

PUNK:

This will turn all of your favorite lyrics into something shouted loudly and out of key, about teenage rebellion from not being all that good at school, not having an easy job that pays good money, or not ever having a girlfriend who was very nice to you.

APPENDIX A: Service Info

Warranty Service

Details concerning Warranty Service are spelled out in the Warranty Card included with your mixer. If it's missing, please let us or your dealer know.

If you think your DFX Mixer has a problem, please do everything you can to confirm it before calling for service. Doing so might save you from the deprivation of your mixer and the associated suffering.

These may sound obvious to you, but there's some things you can check. Read on.

Troubleshooting

Bad Channel

- Is the channel Fader turned up?
- Is the MUTE switch on?
- On mono channels, try unplugging any INSERT devices.
- Try the same source signal in another channel, set up exactly like the suspect channel.

Bad Output

- Are the MAIN MIX faders turned up?
- If it's one of the MAIN OUTs, try unplugging all the others. For example, if it's a TRS MAIN OUT, unplug the associated XLR outputs. If the problem goes away, it's not the mixer.
- If it's a stereo pair, try switching them around. For example, if a left output is presumed dead, switch the left and right cords, at the mixer end. If the left speaker is still dead, it's not the mixer.

Noise

- Turn the channel Faders, AUX RETURN and AUX SEND controls down, one by one. If the sound disappears, it's either that channel or whatever is plugged into it, so unplug whatever that is.

Power

- Our favorite question: Is the POWER switch on? Are all the lights out in your building?
- If the POWER LED is blinking, switch the mixer off for a few seconds, and disconnect all connections except the linecord. Switch it back on, and if the LED continues to blink, the mixer may need repair.

Repair

Service for DFX mixers sold in the USA is available at our factory, located in sunny Woodinville, Washington. Service for Mackie mixers living outside the United States can be obtained through local dealers or distributors.

If your mixer needs service, follow these instructions:

1. Review the preceding troubleshooting suggestions. Please.
2. Call Tech Support at 1-800-258-6883, 8am to 5pm PST, to explain the problem and request an RA (Return Authorization) number. Have your mixer's serial number ready. *You must have an RA number before you can obtain service at the factory.*
3. Keep this owner's manual. We don't need it to repair the mixer.
4. Pack the mixer in its original package. This is *very important*. When you call for the RA number, please let Tech Support know if you need new packaging. Do not use packing "peanuts" or any small packing pieces which could get inside the mixer. Always wrap it in a plastic bag. *Mackie is not responsible for any damage that occurs due to non-factory packaging.*
5. Include a legible note stating your name, shipping address (no P.O. boxes), daytime phone number, RA number, and a detailed description of the problem, including how we can duplicate it.
6. Write the RA number in **BIG PRINT** on top of the box.
7. Ship the mixer to us. We suggest insurance for all forms of cartage. Ship to this address:

Mackie Designs
SERVICE DEPARTMENT
16140 Wood-Red Rd. NE, Ste 5
Woodinville, WA 98072

8. We'll try to fix the mixer within three to five business days. Ask Tech Support for the latest turn-around times when you call for your RA number. The mixer **MUST** be packaged in its original packing box, and must have the RA number on the box. Once it's repaired, we'll ship it back the same way in which it was received. This paragraph does not necessarily apply to non-warranty repair.

APPENDIX B: Technical Info

Specifications

DFX•6, DFX•12

Mixer Section

Frequency Response

Mic Input to any Main output (GAIN at 0 dB):
+0, -1 dB, 16 Hz to 30 kHz

Distortion

THD and SMPTE IMD; 20Hz to 20kHz

Mic Input to Main Output:
< 0.05% @ +4 dBu output

Noise

20Hz to 20kHz BW (150Ω source impedance)

Equivalent Input Noise (EIN):
-127 dBu

Residual Output Noise:
Main, Monitor, & Effects outputs
Channel & Master levels off
-95 dBu

Common Mode Rejection Ratio (CMRR)

60 dB @ 1kHz, Gain @ unity

Crosstalk

Adjacent Inputs or Input to Output:
-90 dB @ 1kHz

Fader Off
-90 dB @ 1kHz

Mute Switch and Break Switch Mute
-80 dB @ 1kHz

Input Level Trim Control Range

0 to +50 dB

Phantom Power

+48V DC on mono channels

Equalization

Low Cut: 75 Hz, -18 dB/octave

Channel EQ:
High ±15 dB @ 12kHz
Low ±15 dB @ 80Hz

Stereo Graphic EQ (5 bands):
Q = 1.414, ISO octave centers
±12 dB @ 60, 250, 1k, 3.5 k, 12 kHz

Mixer Rated Output

Main, Aux, & EFX: +4 dBu
Maximum Rated Output: +20 dBu

Maximum Input Levels

Mic Input: -28 dBu, Gain @ +50 dB
+18 dBu, Gain @ +6 dB

Line Input: -8 dBu, Gain @ +30 dB
+38 dBu, Gain @ -15 dB

Insert Input, Stereo Line Input, Tape Input, and
Effects Return: +20 dBu

Maximum Voltage Gain

Mic Input to
Insert Output: 50 dB
Tape Output: 60 dB
Main Output: 76 dB
Aux Send: 85 dB

Line Input to
Insert Output: 30 dB
Tape Output: 40 dB
Main Output: 56 dB
Aux Send: 66 dB

Stereo Line Input to
Tape Output: 20 dB
Main Output: 40 dB
Aux Send: 50 dB

Tape Input to
Main Output: 22 dB

Effects Return to
Main Output: 22 dB

Input Impedance

Mic Input: 3 kΩ, balanced
Line Input: 40 kΩ, balanced
Insert Input, Stereo Line Input, Tape Input, and
Effects Returns: 10 kΩ, unbalanced

Output Impedance

Main Output, Insert Output, Tape Output, and
Effects Sends: 150 Ω

Digital Effects

Resolution: 16-bit, 2-channel
Number of Presets: 16

Channel Level Set LED (Sensitivity)

0 dBu (normal operating level)

VU Meters

Main L/R
12 segments:
Clip (+16), +12, +8, +4, 0, -4, -8, -12, -16, -20, -24,
and -30

AC Power Requirements

100 - 240 VAC, 50/60 Hz, 30 watts
(Capable of operation from 85% to 110% of rated line
voltage.)

Disclaimer

Since we are always striving to make our products better by incorporating new and improved materials, components, and manufacturing methods, we reserve the right to change these specifications at any time without notice.

"Mackie," the "Running Man" figure, "DFX," and "EMAC" are trademarks or registered trademarks of Mackie Designs Inc.

All other brand names mentioned are trademarks or registered trademarks of their respective holders, and are hereby acknowledged.

©2002 Mackie Designs Inc.
All Rights Reserved.

Dimensions

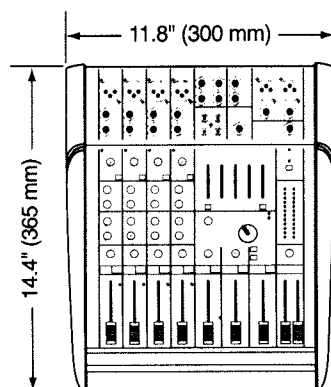
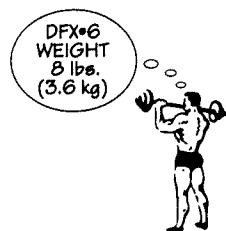
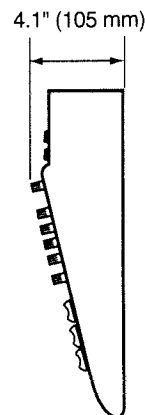
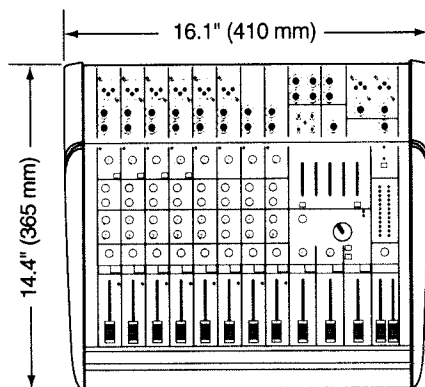

AC Power Considerations

The majority of AC outlets encountered in homes and clubs (in the U.S.) are served by a 240 VAC center-tapped service entrance transformer. This provides two phases of AC power on either side of the center tap, at 120 V each.

If lighting is used in a show, it is preferable to power the lights from one leg of the service, and power the audio equipment from the other leg. This will help minimize noise from the lights coupling into the audio (particularly if SCRs, or light-dimmer switches, are used).

In order to minimize ground loops, the safety grounds for all the outlets should be connected to a common ("star") grounding point, and the distance between the outlets and the common grounding point should be as short as possible.

When setting up for a show, oftentimes you are plugging into an AC power distribution system you know nothing about. You may even be faced with 2-wire outlets that are missing the third safety ground pin. It's a good idea to have a three-wire AC outlet tester in your toolbox so you can check the outlets yourself to make sure they are wired correctly. These testers

will tell you if the polarity of the hot and neutral wires is reversed and if the safety ground is disconnected. Don't use an outlet if it is wired improperly! This is to protect yourself as well as your equipment.

If you find that you must plug into a two-wire outlet, you will need to use a two-wire to three-wire adapter (cheater plug). These come with a metal tab that you put underneath the center screw that holds the AC outlet faceplate in place. This center screw must be grounded. You can check it by connecting the adapter to the outlet and then plugging in your handy-dandy AC outlet tester.



NEVER bypass the AC plug's ground pin. This is dangerous!

**MONO CHANNELS
1-4**

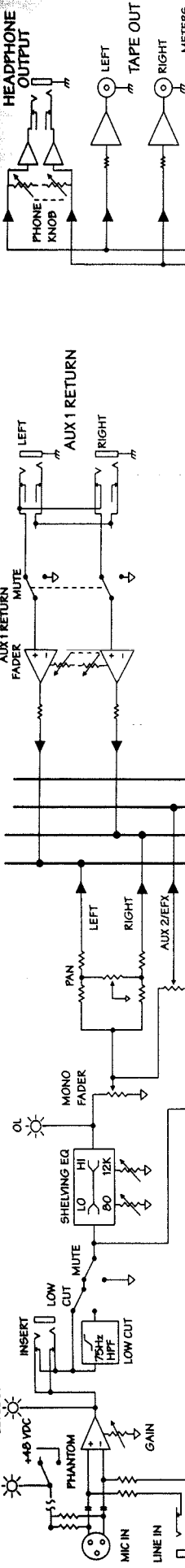

**STEREO CHANNELS
5/6 7/8**

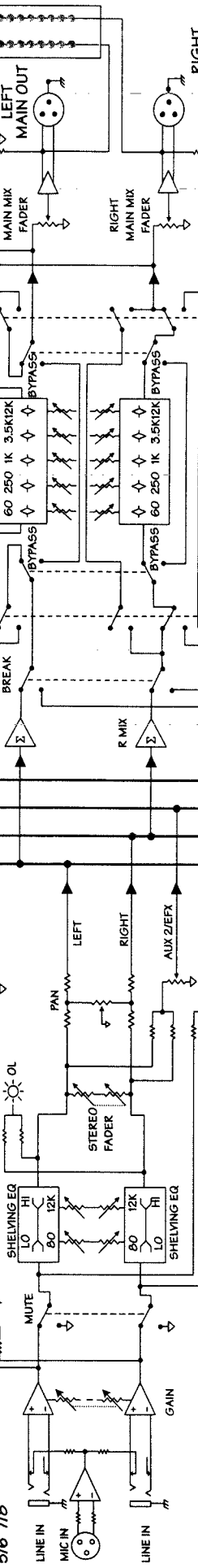

**STEREO CHANNELS
9/10, 11/12 (DFX*12 ONLY)**

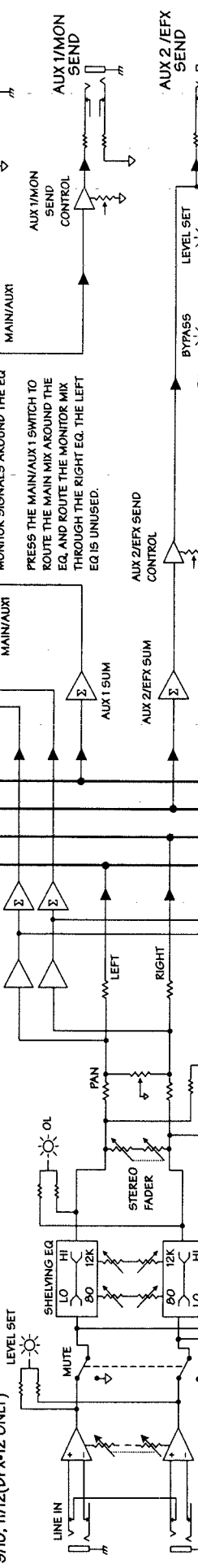

CD/TAPE IN

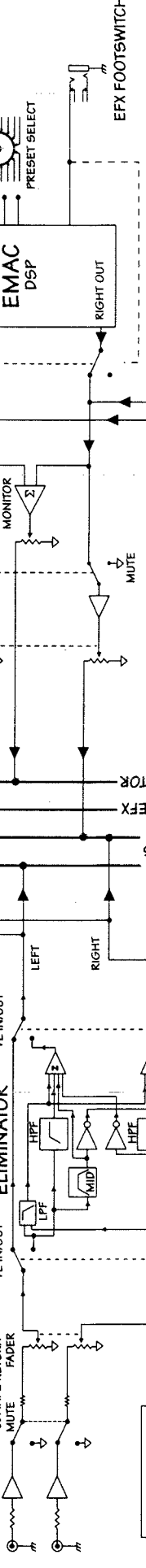

DFX*12 / DFX*6
BLOCK DIAGRAM
SSE 191201

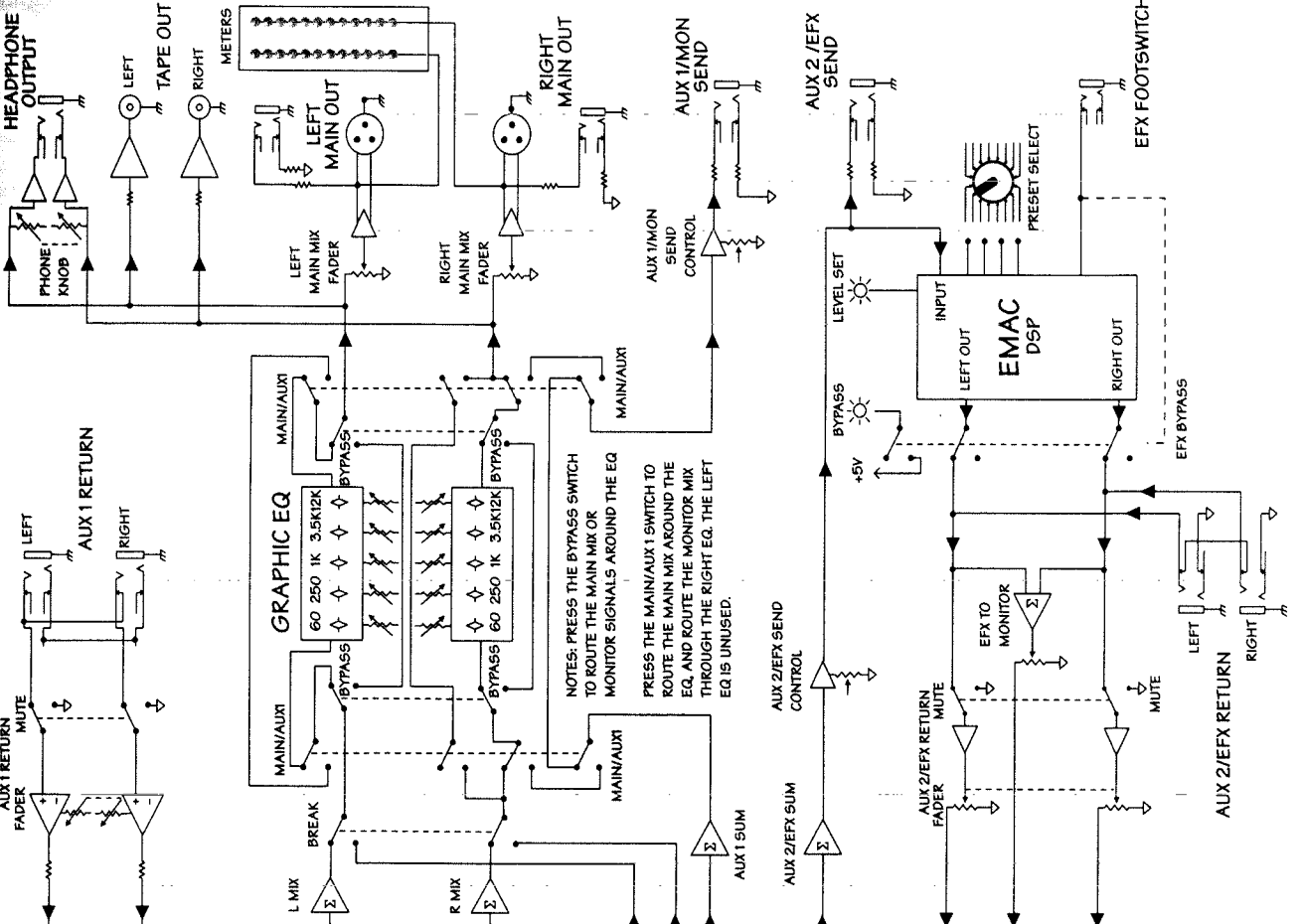

NOTES: PRESS THE BYPASS SWITCH TO ROUTE THE MAIN MIX OR MONITOR SIGNALS AROUND THE EQ.
PRESS THE MAIN/AUX 1 SWITCH TO ROUTE THE MAIN MIX AROUND THE EQ. AND ROUTE THE MONITOR MIX THROUGH THE RIGHT EQ. THE LEFT EQ IS UNUSED.



*Some of the
people at our
factory who helped
design, build, sell,
and support your
product.*

MACKIE

Mackie Designs, Inc.

16220 Wood-Red Rd. NE • Woodinville, WA 98072 • USA

US & Canada: 800/898-3211

Europe, Asia, Central & South America: 425/487-4333

Middle East & Africa: 31-20-654-4000

Fax: 425/487-4337 • www.mackie.com

E-mail: sales@mackie.com