

# Film-Tech

The information contained in this Adobe Acrobat pdf file is provided at your own risk and good judgment.

These manuals are designed to facilitate the exchange of information related to cinema projection and film handling, with no warranties nor obligations from the authors, for qualified field service engineers.

If you are not a qualified technician, please make no adjustments to anything you may read about in these Adobe manual downloads.

[www.film-tech.com](http://www.film-tech.com)

CONTENTS

<u>SECTION</u>	<u>TITLE</u>	<u>PAGE</u>
1.0	INTRODUCTION.	1
1.1	PRODUCT DESCRIPTION	
1.2	FRONT PANEL	
1.3	REAR PANEL	
1.4	SPECIFICATIONS	
2.0	INSTALLATION.	4
2.1	UNPACKING & INSPECTION	
2.2	MOUNTING	
2.3	PRECAUTIONS	
2.4	POWER REQUIREMENTS	
3.0	NOTES .	5
3.1	TROUBLESHOOTING	
3.2	ADJUSTING ±15V LEVELS	
3.3	REMOVING/REPLACING POWER SUPPLY	
3.4	MOLEX-PIN DESIGNATIONS	
4.0	SCHEMATICS .	7
4.1	STANDARD MODULAR FRAME	
4.2	REAR-CHASSIS SUBASSEMBLY	
5.0	APPENDIX .	9
5.1	STANDARD 900 MODULE HOOKUP INFORMATION	
5.2	F-900-U POWER HOOKUP INFORMATION	

\* \* \* \* \*

1.0	INTRODUCTION
1.1	PRODUCT DESCRIPTION

The dbx Model F-900 Mainframe is designed for use with the 900 Series Signal-Processing modules. In 5½" of vertical 19" rack space, the F-900 provides power and barrier-strip signal connections for eight (8) 900 Series modules.

The 900 Series is a modular system that eliminates redundant packaging and saves rack space. In the studio or on the road, the right combination of processors can be set up or interchanged quickly and easily.

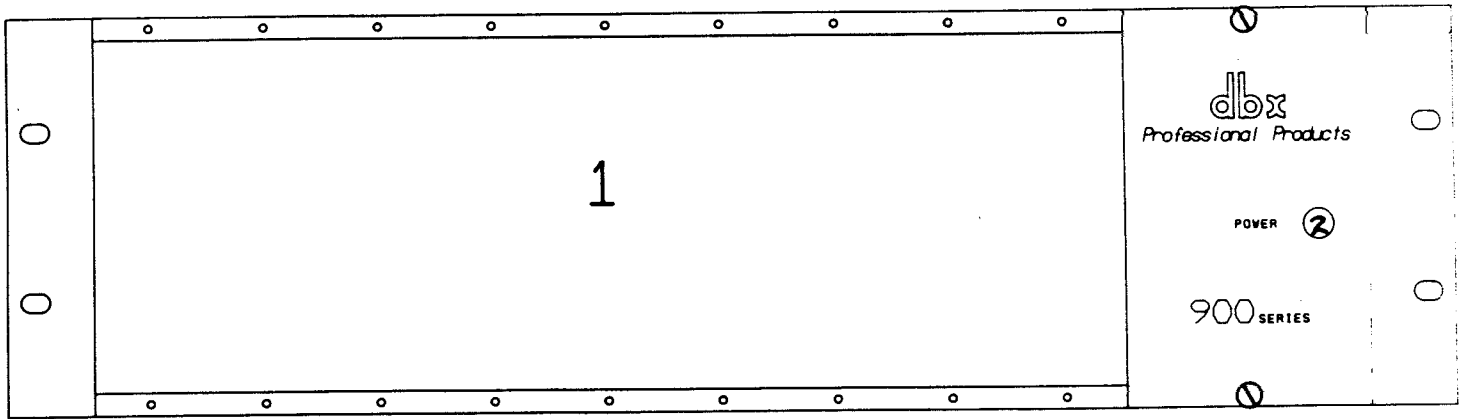

FIGURE 1.2

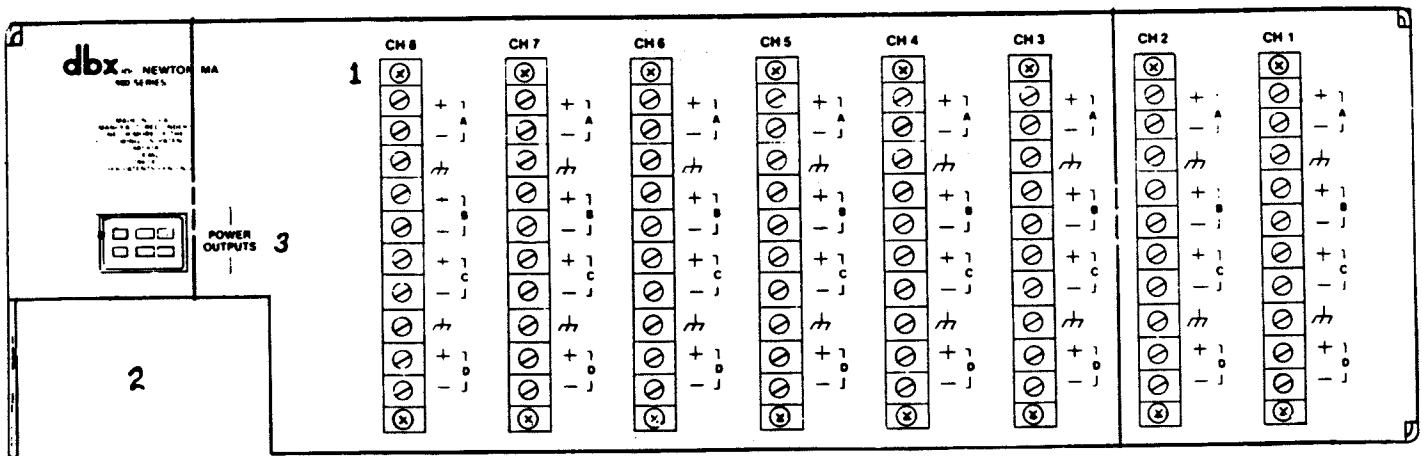

FIGURE 1.3

## 1.2 FRONT PANEL

1. 900 SERIES MODULES - Any combination is possible.
2. AC POWER BUTTON - Push once to turn the 900 ON, and push again to turn it off. The button is illuminated when the power is ON.

## 1.3 REAR PANEL

1. TERMINAL STRIPS - The terminal strips provide audio and control connections for the modules.
2. AC POWER CORD SOCKET AND FUSEHOLDER - The NEMA 3-wire grounded power cord must be removed to replace the fuse. Always replace the 1-amp fuse with the same size and type. Unless otherwise specified, the 900 is delivered with the power supply set for 120 VAC operation. Check the adjacent label on the rear panel. The 900 can be set for other voltages by following the procedures in Section 2.4. See Fig. 2.4 for closeup.
3. POWER OUTPUTS - This socket provides power for externally mounted modules. See Fig. 3.1.

Figure 3.1 shows the pin designation for powering modules mounted outside of the rack. The 900's power supply provides 1.2 amps, so the total draw from modules in the rack and outside cannot exceed this figure. Calculate the total demand before wiring any external modules.

## 1.4 SPECIFICATIONS

Number of slots available	9: 8 powered and 1 nonpowered
Operating Temperature	32°F to 140°F (0°C to 60°C)
Connectors	Barrier Strips
Dimensions	5½" high x 19" wide x 13½" deep (133.35mm high x 482.60mm wide x 342.90mm deep)
Power Requirements	120V ac, 50-60 Hz, 40 watts; can be set for 100,200, or 240 V ac.

2.0 INSTALLATION

2.1 UNPACKING AND INSPECTION

The carton should contain:

1. Model 900 Mainframe.
2. Instruction Manual.
3. Warranty Card.

The Model 900 was carefully inspected and tested at the factory. Contact your dealer in the event of any problems. We suggest saving the shipping carton and packing materials for safely transporting the unit in the future.

2.2 MOUNTING

The 900 Mainframe mounts in a standard 19" rack and occupies 5 $\frac{1}{4}$ " of vertical panel space. To avoid overheating of the mainframe and modules, 1-3/4" of unused rack space should be allowed above and below the 900 for adequate air circulation. If the 900 is used in an enclosed space, a fan should be installed. Avoid high humidity and water.

2.3 PRECAUTIONS

Mounting electronics equipment and connecting cables as far as possible from motors and large power transformers lessens the possibility of picking up the 60Hz hum these devices can produce.

2.4 POWER REQUIREMENTS

The 900 is set for 120VAC, 50-60Hz operation as supplied. It may be reset for 100, 220, or 240VAC operation. A label should be affixed adjacent to the power connector to indicate when the line voltage setting has been changed from 120VAC. The 900 draws about 40 watts.

To change the nominal AC line voltage requirement, unplug the power cord and slide the window to the left. See Figure 2.4. Use the fuse puller to remove the fuse. Beneath the fuse holder is a small circuit board with a number indicating the line voltage. With a needle-nose pliers, gently pull the board out. Position it so the desired voltage will be visible once the board has been replaced.

REPLACE THE AC FUSE WITH ONE OF THE APPROPRIATE RATING:

100VAC	1 Amp
120	1
220	$\frac{1}{2}$
240	$\frac{1}{2}$

Re-label the rear panel to clearly indicate the selected line voltage. Slide the window back and install a suitable power cord.

NOTE: Early production models of the F-900 were manufactured with the AC power connection/fuse assembly inverted. If your frame has the word FUSE on the fuse puller lever printed upside down, place F-900 upside down (FUSE now reads properly) before following instructions.

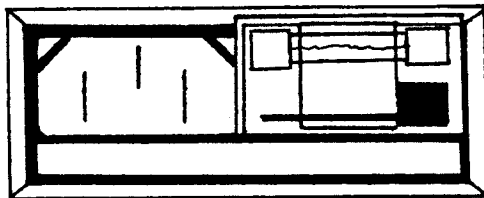

FUSE HOLDER/VOLTAGE SELECTOR

FIGURE 2.4

### 3.0 NOTES

#### 3.1 TROUBLESHOOTING

The 6-pin cinch connector on the rear panel of the F-900 permits rapid verification of proper power supply operation. Each of the four output voltages ( $\pm 24V$ ,  $\pm 15V$ ) used to power 900 Series modules is brought out to a pin on this connector as shown below:

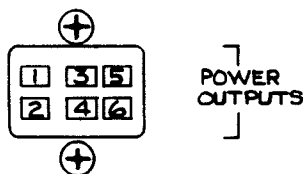

#### J5 PIN DESIGNATIONS

1. +24V
2. +15V
3. REG GND
4. REG GND
5. -24V
6. -15V

FIGURE 3.1

### 3.2 ADJUSTING REGULATED $\pm 15V$ LEVELS

The power supply circuitry of the F-900 is designed to have the  $-15V$  regulated output track the  $+15V$  output. This means that both voltages can be adjusted equally and simultaneously with a single control. This control (R10) is a multi-turn trimmer which can be easily accessed by removing the top cover of the F-900. It is mounted on the regulator p.c. card with the adjustment screw on the top edge of the card. See Figure 3.2.

### 3.3 REMOVING/REPLACING POWER SUPPLY

The entire power supply, less the power transformer, can be easily removed from the F-900 as follows:

1. Remove power from the frame by disconnecting the AC mains cable from the NEMA connector on the F-900's rear panel.
2. Loosen the two front panel thumb-screws holding the F-900 identification panel in place, and remove the panel.
3. Remove the four screws (2-top, 2-bottom) which pass through the extruded front rails of the F-900 into the aluminum heat sink mounted on the power supply p.c. card.
4. Pull the power supply card out the front of the F-900, as if it were any other module being unplugged from the frame.
5. When the card is half-way out of the frame, unplug the Molex connector which brings the power transformer leads to the card. Then remove the card completely by sliding it forward and out of the frame.

### 3.4 MOLEX-PIN DESIGNATIONS

Molex-pin numbers called out on the schematics for the F-900 refer to identification numbers molded onto the connectors themselves. Mating connectors DO NOT interface on a PIN 1 to PIN 1, PIN 2 to PIN 2 basis. The actual interfacing between the F-900 sub-chassis and the F-900 connector shroud is as below:

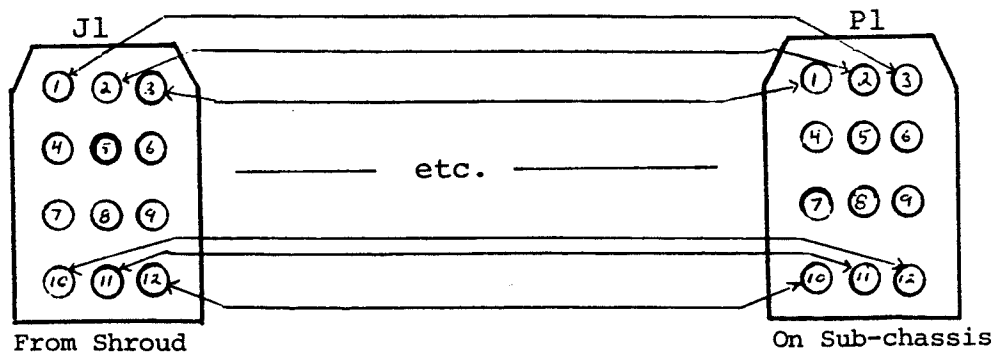
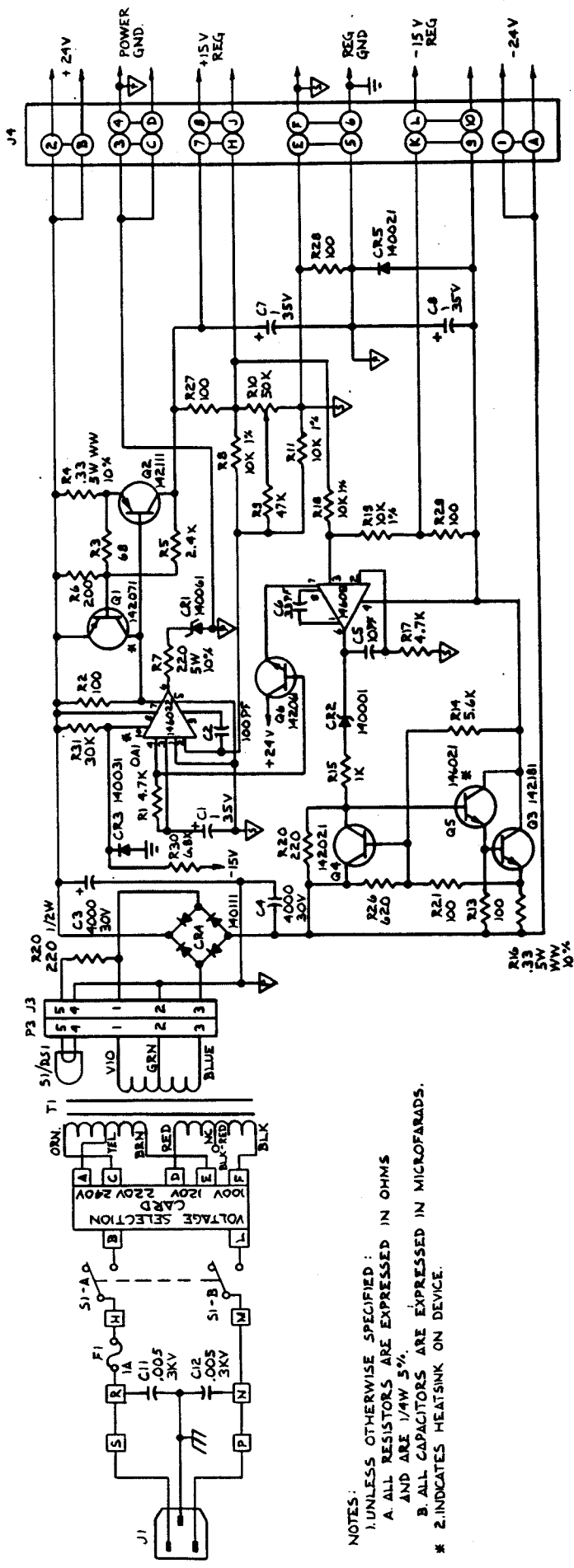

FIGURE 3.4

dbx MODEL F-900 MAIN FRAME POWER SUPPLY SCHEMATIC



NOTES:  
 1. UNLESS OTHERWISE SPECIFIED:  
 A. ALL RESISTORS ARE EXPRESSED IN OHMS  
 AND ARE 1/4W 5%.  
 B. ALL CAPACITORS ARE EXPRESSED IN MICROFARADS.  
 \* 2. INDICATES HEATSINK ON DEVICE.

Manufactured under one or more of the following U.S. patents: 3,681,618; 3,714,462; 3,789,143; 4,101,849; 4,097,767. Other patents pending.



# dbx MODEL F-900 REAR CHASSIS SUBASSEMBLY SCHEMATIC

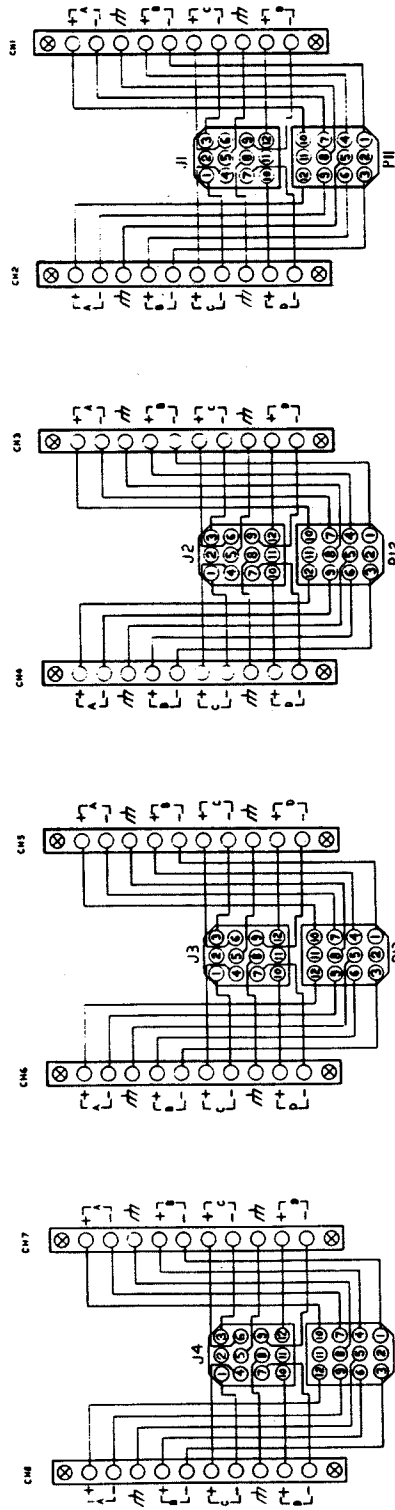

- NOTES**
- 1 REFERENCE SCHEMATIC, REAR PANEL, MODULAR FRAME #310074.
  - 2 ALL CONNECTORS ARE SHOWN IN THE WIRING POSITION.
  - 3 REFERENCE, REAR PANEL, SUBASSEMBLY DRAWING #180088 FOR COMPLETE WIRING AND CABLE ASSEMBLY DIAGRAMS.
  - 4 \*38010 (FOR WIRING PH P2, P3, P4)
  - 5 \*38010 (FOR WIRING PH P1, P3, P4)
  - 6 \*38010 (FOR WIRING J5, P30)

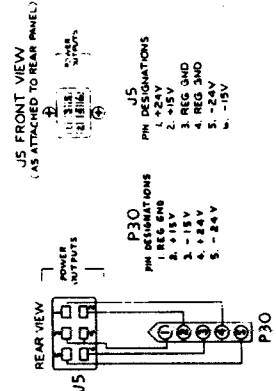

Manufactured under one or more of the following U.S. patents: 3,681,618; 3,714,462; 3,789,143; 4,101,849; 4,097,767. Other patents pending.

APPENDIX

TYPICAL 900 MODULE HOOKUP INFORMATION

900 TERMINALS	902 DE-ESSER	903 COMP/LIMITER	904 NOISE GATE	905 PARAMETRIC	941 TYPE II DUAL ENCODE	942 TYPE II DUAL DECODE	411 TYPE I ENCODE/DECODE
] A ] + -	AUDIO INPUT				CH. A INPUT		DECODE INPUT
	AUDIO OUTPUT					CH. B OUTPUT	ENCODE OUTPUT
] B ] + -	DETECTOR INPUT		KEY INPUT		NOT USED	CH. B INPUT	ENCODE INPUT
	CV OUTPUT		CV INPUT		NOT USED	CH. A OUTPUT	DECODE OUTPUT

FOR OTHER MODULES, REFER TO OPERATOR'S MANUAL  
OF THE MODULE BEING USED.

## 5.2 F-900-U POWER HOOK-UP INFORMATION

The F-900-U is an unpowered version of the F-900 frame. It is identical to the F-900 except that the power-supply components (i.e., power transformer, mains switch, fuseholder and regulator-supply cord) have been omitted. Power may be applied via the 6-pin cinch connector on the unit's rear panel or the 5-pin Molex connector on the subchassis, as shown below.

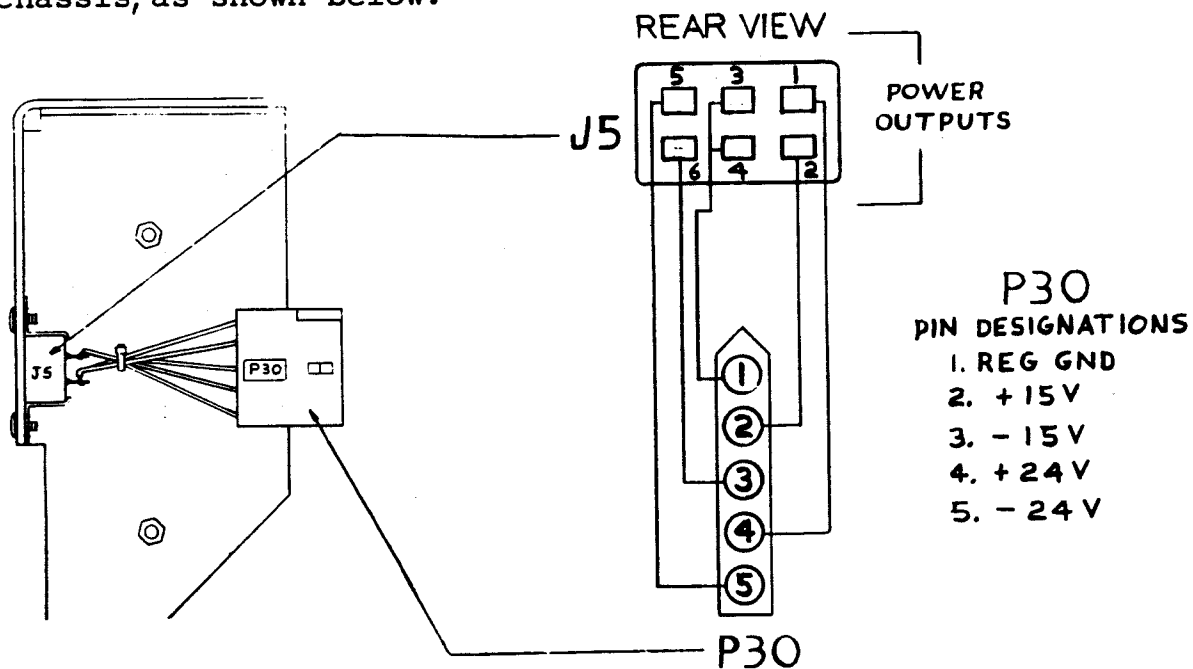

The power supply should be capable of delivering at least 1 ampere of combined  $\pm 24V$  DC ( $\pm 1.00$ ) at less than 1% ripple and  $\pm 15V$  DC ( $+0mV, -5mV$ ).

## 6.0 FACTORY SERVICE

The dbx Customer Service Department is prepared to give additional assistance in the use of this product. All questions regarding interfacing dbx equipment with your system, service information or information on special applications will be answered. You may call during business hours (telephone 617-964-3210) or write to:

dbx Inc.  
71 Chapel Street  
Newton, MA 02195  
Attn: Customer Service Department

Should it become necessary to have your equipment factory serviced:

1. Please repack the unit including a note describing the problem along with the day, month and year of purchase.
2. Send the unit freight prepaid to:

dbx Inc.  
224 Calvary Street  
Waltham, MA 02154  
Attn: Repair Department

3. We also recommend that you insure the package and send it via United Parcel Service whenever possible.
4. Please direct all inquiries to the dbx Customer Service Department.

Outside the United States - contact your nearest dbx dealer for the name of an authorized repair center.