

Film-Tech

The information contained in this Adobe Acrobat pdf file is provided at your own risk and good judgment.

These manuals are designed to facilitate the exchange of information related to cinema projection and film handling, with no warranties nor obligations from the authors, for qualified field service engineers.

If you are not a qualified technician, please make no adjustments to anything you may read about in these Adobe manual downloads

www.film-tech.com

XTD-33

Digital Crossover

INSTRUCTION MANUAL

 **USL, Inc.**

Quality Cinema Products

Ultra*Stereo Labs, Inc. • 181 Bonetti Drive
San Luis Obispo, CA 93401

Telephone 805.549.0161 • e-mail usl@uslinc.com

One Year Limited Warranty



Ultra*Stereo Labs, Inc. warrants that each product manufactured by it will be free from defects in material and workmanship under normal usage for a period of one (1) year after its purchase new from an authorized dealer. Our obligation under this warranty is limited to repairing or replacing any product or component which we are satisfied does not conform with the foregoing warranty and which is returned to our factory, freight paid, or serviced by one of our authorized contractors. The foregoing warranty is exclusive and in lieu of all other warranties, whether expressed or implied. Such warranty shall not apply to any product or component (A) repaired or altered by anyone other than Ultra*Stereo Labs or an authorized service contractor; (B) tampered with or altered in any way or subjected to misuse, negligence or accident or (C) which has been improperly connected, installed or adjusted other than in accordance with Ultra*Stereo Labs instruction.

 **USL, Inc.**

Quality Cinema Products

© 2000 All Rights Reserved

Ultra*Stereo Labs, Inc.

181 Bonetti Drive

San Luis Obispo, CA, 93401USA.

Telephone 805.549.0161

FAX 805.549.0163

e-mail: usl@uslinc.com

Table of Contents

Topic	Page
Introduction	5
Scope of this Manual	5
Safety Notices	5
Unpacking	6
Configurations and Options	6
Technical Specifications	7
Declaration of Conformance, CE	7
XTD-33 Front Panel	8
XTD-33 Rear Panel	10
Theory of operation	12
Normal operation	12
Speaker Protection (Anti-Thump)	13
Backup System	13
Installation	14
Equipment needed	14
System Hardware Mounting and Grounding	14
Power Connection, Main Voltage Selection, and Fuse ..	15
Rear Panel Signal Input Connections	16
Rear Panel Signal Output Connections	17
Optional Signal to Chassis Grounding	17
Front Panel Controls	18
Alignment	19
Selecting Speaker Type	19
Setting Input levels	19
Setting Output levels	20
Emergency Bypass setup	20
Operation	21
Normal Operation	21
Bypass Operation	21
Updating the Program and Crossover Files	21
Appendix	22
Connector pinouts	22
Crossover List	22
Trouble Shooting	23
Fuse replacement	23

Please record the following information for your records:	
Model: _____	Serial Number: _____
Date of Purchase: _____	Purchased from: _____

Introduction

General

The XTD is designed as an easy-to-set-up, high performance digital crossover. It is designed to match the most commonly used speaker types currently produced by several manufacturers. The 96kHz sample rate, 24-bit resolution and flexible firmware assures it will meet the demands of future speaker designs. It may be used with other equipment, such as room equalization equalizers, to isolate specific functions and provide a complete audio processing system. The XTD is compatible with all commercially available sound processors.

Scope of this Manual

This manual is to aid in the installation and operation of the XTD-33 Digital Crossover. Because the XTD is designed for use with specific speaker systems, there may be situations that the XTD cannot correct (e.g., a room with excessive acoustic absorption or a power amplifier without sufficient power). Please contact USL if you have any questions

Safety Notices

Review the following safety precautions to avoid injury and prevent damage to this product. To avoid potential risk, use this product only as specified and only for the purpose described in the instruction manual.

To Avoid Fire and Personal Injury:

- **Use Correct Power Cable.** Use only the power cable provided. Ensure that the AC power outlet is located near the product and is easily accessible.
- **Use a Correctly Grounded Power Source.** The Power Supply earth ground is established through the ground conductor in the power cable. To avoid the potential of electric shock, the ground conductor must be correct.
- **Observe Source Ratings.** To avoid risk of fire or electric shock, the power source must be 110 - 120 VAC, 60Hz or 220 - 240 VAC, 50 Hz.
- **Do Not Operate this Product with Any Enclosures Opened or Removed.**
- **Avoid Exposed Circuitry.** Do not attempt to open the Power Supply because its safety certification would be invalidated.
- **Do Not Operate with Suspected Failures.** If you suspect there is damage or malfunction with this product, call the factory.
- **Do Not Attempt Repair.** Only a trained factory service person is authorized to repair this product.
- **Do Not Operate this Product Near Heat Sources.** This product should not be located near heat sources such as radiators, heat registers, or stoves.

- **Provide Proper Ventilation.** The operating temperature should be between 0° C and 50° C. The humidity should be <90% at 40° C or below and <60% at 41° C to 50° C. The cooling method is by convection.
- **Keep Product Surfaces Clean and Dry.** Disconnect the power cable from the power source before cleaning. Do not use liquid cleaners or aerosol cleaners. Use a damp cloth for cleaning.
- **Do Not Push Objects Into Opening of this Product.** Never insert objects into the product through openings.
- **Do Not Operate In Wet or Damp Conditions.**
- **Do Not Operate In an Explosive Atmosphere.**
- **Prevent the Spilling of Liquids onto the System Components.**
- **Inspect the power cable and all cables prior to use.** Confirm that the power cable and other interconnecting cables are free from damage.

Safety Standard

The EN 60065 standard specifies safety design requirements that reduce or eliminate the risk of personal injury to both the product user and service personnel. This product is designed and tested to meet the standards of the International Electrotechnical Commission (IEC) European Norm (EN) 60065 (The Standard for Information Technology Equipment Including Electrical Business Equipment).

Unpacking

The shipping box contains:

This Owner's Manual

XTD-33 Screw Terminal Plugs (4)

Power Cord IEC type for the country specified when ordered

Backup Power Transformer (Stepdown Transformer also required for the Backup Transformer in 230 VAC systems)

Configurations

The XTD has three available channels which may be configured with two or three bands for each channel simultaneously. Inputs and outputs may individually be configured as balanced or unbalanced. When an input or output is used in the unbalanced mode, the negative signal should be connected to signal ground ("E").

Options

If the standard speaker selections do not match your configuration, USL may be able to provide you with a customized program to optimize your audio.

Technical Specifications

- Size: 1 unit Rack Mount (standard reference) 19" wide (including rack ears; 17.5" chassis only), 8" deep, 1.75" high
- Weight: 8 lbs.
- Electrical: AC mains 115VAC @ 1 Amp or 230VAC @ 1 Amp
- Backup Power: 16VAC @ 750mA. A 115VAC wall mount AC adapter is supplied with the unit. (230VAC operation requires a stepdown transformer.)
- Audio Inputs: 0dB ref. - 300mV rms, +26dB maximum Balanced/Unbalanced via one 10-pin detachable screw terminal plug for Left, Center, and Right channels
- Audio Outputs: Two or Three Bands for each Channel. Transformer Simulated Balanced/Unbalanced via three 10-pin detachable screw terminal plugs, one for each channel. Nominal levels are unity gain relative to the input levels adjustable by the front panel volume controls (0-100%).

Declaration of Conformance, CE

Meets intent of Directive 89/336/EEC for Electromagnetic Compatibility and 93/68/EEC Low-Voltage Directive 73/23/EEC for Product Safety. Compliance was demonstrated to the following specifications as listed in the Official Journal of the European Communities:

EN55103-1: 1999 - Emissions:

IEC1000-3-2 - Limits for Harmonic Current Emission

IEC1000-3-3, Part 3 - Limits of Voltage Fluctuations and Flicker in
Low Voltage Supply Systems

EN550103-2: 1999 - Immunity:

EN55013 Sec 3.2 - Mains Terminal Disturbance

EN55013 Sec 3.5 - Disturbance Power Test

Low Voltage Directive 73/23/EEC:

EN 60065 - Safety of Information Technology Equipment,
Including Electrical Business Equipment

XTD-33 Front Panel

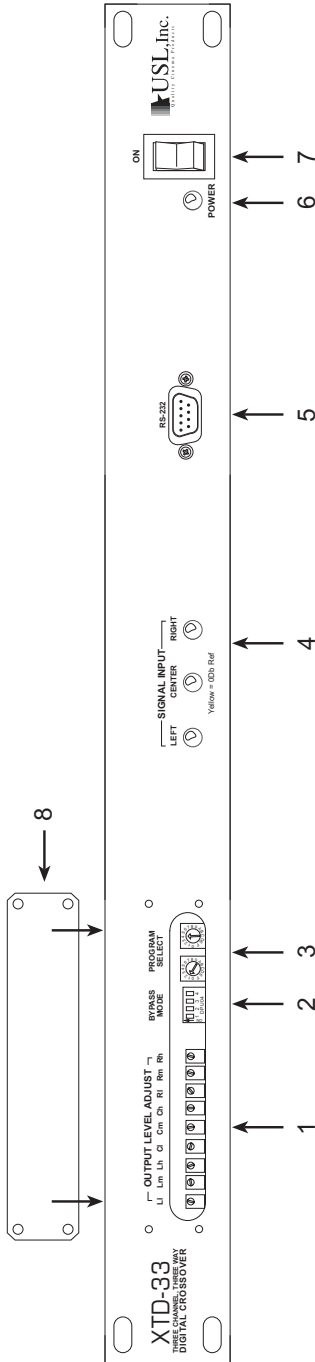

- 1. Output Level Adjust** - Nine multi-turn potentiometers to set the individual output levels for each frequency band in each channel.
- 2. Bypass Mode** - These switches configure the bypass electronics for either two-or-three-way operation (should always be set to match the speaker configuration). Up (or ON) is two-way; Down (or OFF) is three-way. All switches must be set the same way - either all Up or all Down.
- 3. Program Select** - These two switches determine the processing applied to the signals and output configuration. These must be set to match the speakers according to the chart in the Appendix or the speakers may be damaged.
- 4. Signal Input LED** - These indicate whether the XTD is receiving the proper signal level. Off indicates the level is below -54 dB. Green indicates the signal is present at normal levels. Yellow indicates the signal is within ± 0.5 dB of the 0dB (300mV rms) reference point. Red indicates that the signal is over +23dB and in danger of clipping or distorting.
- 5. RS-232 Port** - This port is used to update the firmware. This must be done by a qualified technician. Instructions are included in the update package.
- 6. Power LED** - Under normal conditions, with the Power Switch On and no faults, the LED will be Green and the unit will be operating in the Digital Mode. If the unit is operating in the Bypass (analog) Mode, the LED will be Red and may indicate that servicing is required.
- 7. Power Switch** - Controls the primary power to the XTD. Must be On to operate in the Digital Mode.
- 8. Access Panel Cover** - Protects the XTD settings and keeps the dust out.

XTD-33 Rear Panel

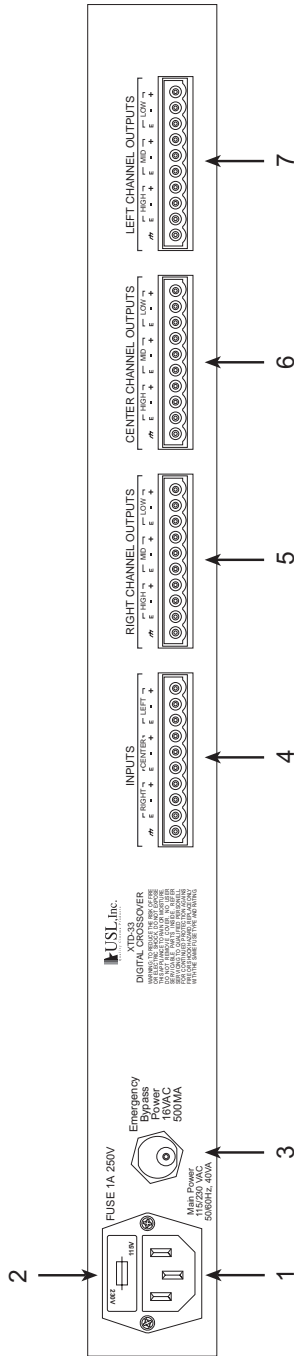

- 1) **IEC Power inlet** - Accepts a standard IEC cord
- 2) **Fuse Holder** - Determines AC Mains configuration. Must be set to match the local AC Mains voltage or the XTD may be damaged or not operate properly.
- 3) **Emergency Bypass Power** - Connect the furnished external power supply here.
- 4) **Inputs** - Accepts the Left, Center, and Right signals from the Cinema Processor or other audio source. Balanced or Unbalanced signals may be used. In Unbalanced mode, the negative signal input should be connected to audio source ground.
- 5) **Right Channel Outputs** - Provides the signal outputs from the XTD in two or three bands as determined by the Program Select and Bypass Mode switches on the front panel. Balanced or Unbalanced signals may be used. In Unbalanced mode, the negative signal should be connected to signal ground ("E").
- 6) **Center Channel Outputs** - Provides the signal outputs from the XTD in two or three bands as determined by the Program Select and Bypass Mode switches on the front panel. Balanced or Unbalanced signals may be used. In Unbalanced mode, the negative signal should be connected to signal ground ("E").
- 7) **Left Channel Outputs** - Provides the signal outputs from the XTD in two or three bands as determined by the Program Select and Bypass Mode switches on the front panel. Balanced or Unbalanced signals may be used. In Unbalanced mode, the negative signal should be connected to signal ground ("E").

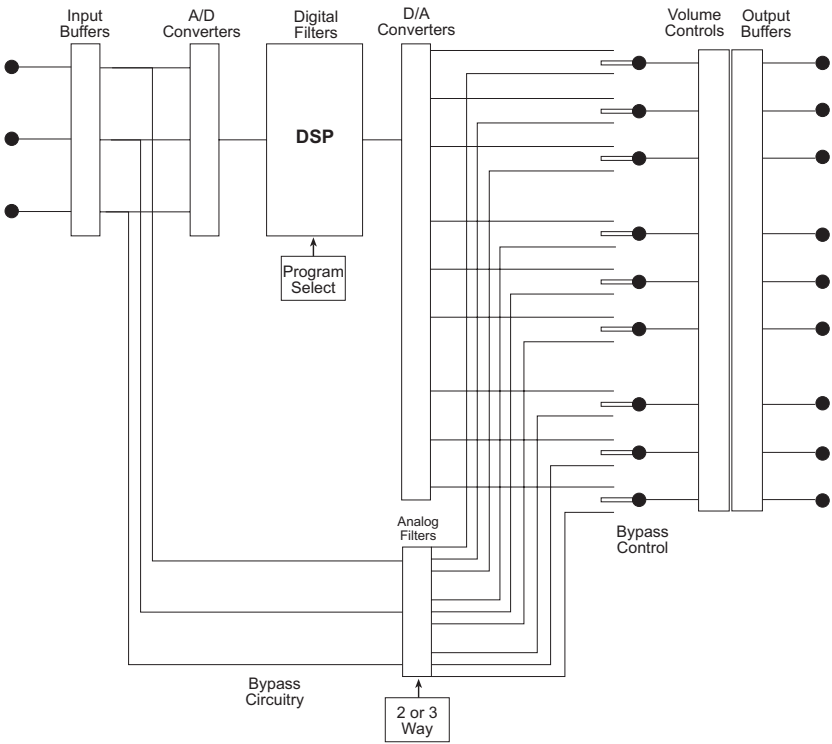

XTD-33 Block Diagram

Theory of operation

Normal operation

Under normal operation, the input signal is conditioned and converted from an analog waveform to digital information at a sample rate of 96 kHz (twice that of a normal music CD). The digital data is then processed in a single chip Digital Signal Processor (DSP) which analyzes the waveform, breaks the signal into the appropriate audio bands and impresses the desired acoustic curve onto the information. These acoustic curves are shaped to match a manufacturer's specific speaker response selected by the switches on the XTD front panel. The data is then converted back to analog waveforms and passed through individual volume controls to the output Transformer Simulators. The Simulators provide a balanced line output which may also be used in an unbalanced configuration by shorting the unused output to ground

Speaker Protection (Anti-Thump)

To minimize damage to the speakers, an anti-thump system shorts the balanced line outputs together during power on or off. However, to assure the best protection, it is recommended that the power amplifiers always be the last to be turned on and the first to be turned off.

Backup System

It is USL's policy to try to provide a "safety net" when possible. The backup system here allows the XTD to continue to operate if the primary XTD power supply fails or there is a malfunction in the Digital Signal Processing part of the unit. The Backup Power Transformer constantly feeds into the analog portion of the circuitry, should the primary supply fail, the backup will take its place and the Power Supply LED will change from green to red. The Input signals will be rerouted around the digital portion of the circuitry and into a conventional analog crossover. This crossover can be configured as either a two-or-three-band type by means of front panel switches. The signals are then directed to the volume controls as noted in the Normal Operation above. These crossovers are of a generic 12dB per octave type but would not be optimized for all models of speakers. The crossover points are located at approximately 500 Hz and 1800 Hz in the three-band mode and 500 Hz in the two-band mode. Should the digital processing malfunction for some unforeseen reason, turning the power switch off will activate the bypass system. Obviously, the Backup System is intended for temporary use until the unit can be restored to proper operation.

Installation

Equipment needed

Small Phillips screwdriver

Straight blade screw driver with 1/8" wide tip (or slightly smaller) or alignment tool

Wire strippers

Audio Cable - (determine your configuration first)

For Balanced and Unbalanced Lines - Individual two-conductor with shield or three pairs cable with individual shield per pair

Two AC mains Outlets (one for mains power, one for the backup power adapter)

System Hardware Mounting and Grounding

Rack mount the XTD with bolts (not supplied) appropriate to your setup. To assure good chassis grounding, use a star washer between at least one bolt head and XTD.

Power Connection, Main Voltage Selection, and Fuse

Determine whether 115 or 230 VAC operation.

For 115VAC Operation:

(A 1 Amp fuse has been installed in the fuse holder at the factory.)

- 1) Verify that the fuse holder is installed into the IEC connector housing so that the "115" is correctly oriented and readable.
- 2) Insert the IEC power cord with the appropriate plug into the IEC connector and the AC mains source
- 3) Emergency Power Supply - Plug the power adapter 16VAC plug into the jack on the rear of the XTD.
- 4) Insert the adapter into the AC mains source

For 230VAC Operation:

- 1) Insert/verify a 1 amp fuse is in the fuse holder.
- 2) Insert the fuse holder into the IEC connector housing so that the "230" is correctly oriented and readable.
- 3) Insert the IEC power cord with the "Euro" plug into the IEC connector and the AC mains source
- 4) Emergency Power Supply - Plug the power adapter 16VAC plug into the jack on the rear of the XTD.
- 5) Plug the power adapter into a stepdown transformer.
- 6) Insert the transformer/adapter into the AC main source.

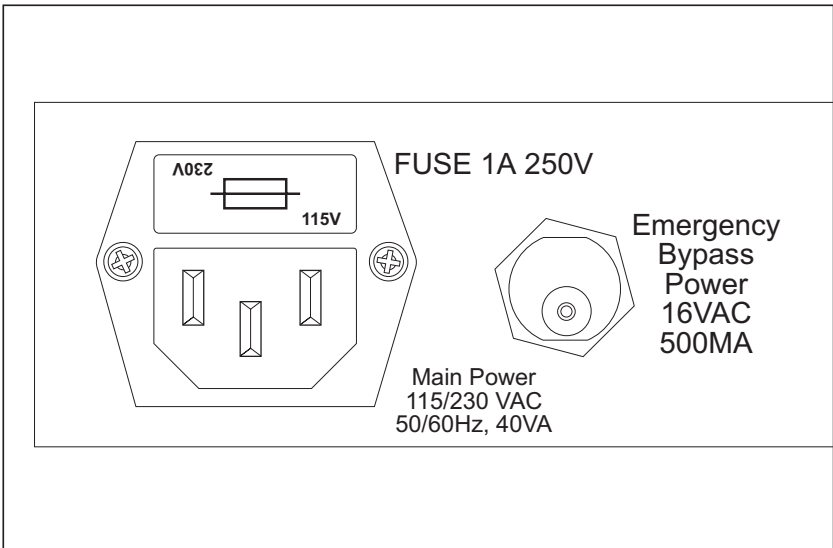

XTD-33 Power Connection

Rear Panel Signal Input Connections

Balanced Inputs

The XTD has balanced inputs for the cleanest possible signal. For each channel, connect the audio source positive output to the positive input of the XTD. Connect the audio source negative output to the negative input of the XTD. Connect the cable shield only to the XTD signal ground ("E") to minimize hum due to ground loops.

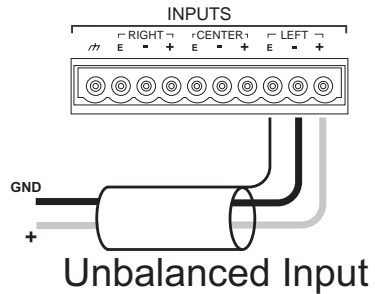
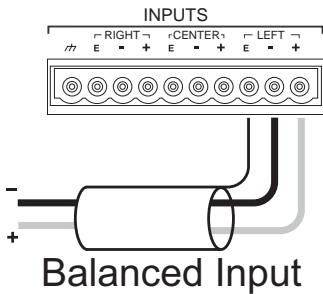

Unbalanced Inputs

For each channel, connect the audio source positive output to the positive input of the XTD. Connect the audio source negative output to the negative input of the XTD. Connect the cable shield only to the XTD signal ground ("E") to minimize hum due to ground loops.

Rear Panel Signal Output Connections

Three-Way Crossover Connection - use all three output bands: Low, Mid, High

Two-Way Crossover Connection - use only Low and High bands

Balanced Outputs

For each band in each channel, connect the XTD positive output to the positive input of the Amplifier. Connect the XTD negative output to the negative input of the Amplifier. Connect the cable shield only to the Amplifier signal ground to minimize hum due to ground loops

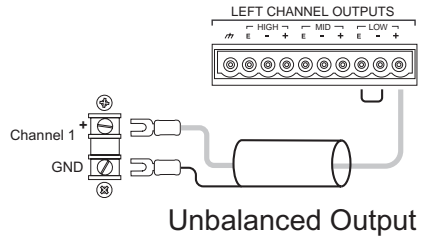
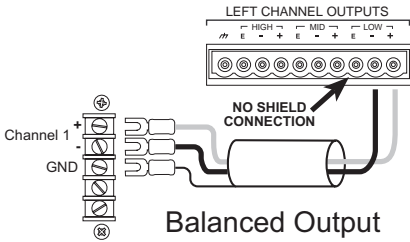

Unbalanced Outputs

The outputs of the XTD use a solid state transformer simulator. BOTH POSITIVE AND NEGATIVE OUTPUTS MUST BE CONNECTED SOMEWHERE. (If your Amplifier does not have balanced inputs, the XTD negative output needs to be connected to the XTD signal ground ["E"] by a short piece of wire.) For each band in each channel, connect the XTD positive output to the positive input of the Amplifier. Connect the XTD negative output to the signal ground output ("E") with a short piece of wire. Connect the cable shield only to the Amplifier to minimize hum due to ground loops

Optional Signal to Chassis Grounding

If you wish to connect the Signal Ground ("E") to the Chassis Ground, install a jumper between the two left terminal block pins on only one of the terminal blocks (any terminal block).

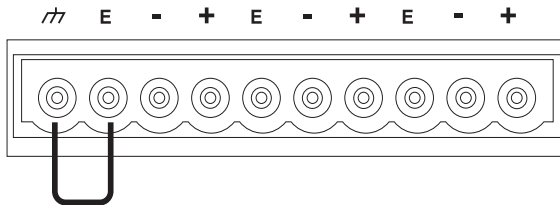

Front Panel Controls

- The only control designed to always be available is the Power Switch. In the ON position power is supplied via the AC Mains, the Power LED will be Green, the Digital Crossover section of the XTD is enabled, and the Analog crossover is disabled. When the Power Switch is in the OFF position, power is supplied by the Emergency Bypass Supply, the Power LED will be Red, the Digital Crossover section of the XTD is disabled, and the Analog crossover is enabled.

- Behind the access panel are the Digital Configuration switches, Analog Crossover Mode selector switches, and the volume controls for the nine outputs. Digital Configuration switches allow for 100 different speaker configurations as identified in the Appendix.

Analog Crossover Mode selector switches allow the emergency bypass circuitry to be configured for two-way or three-way systems and should be set to match the Digital Configuration. Up (or On) is two-way; Down (or Off) is three-way.

The Volume Controls allow the nine output signal levels to be adjusted. These work in either the Normal or Bypass modes and adjustment should not be needed when switching between the two.

Alignment

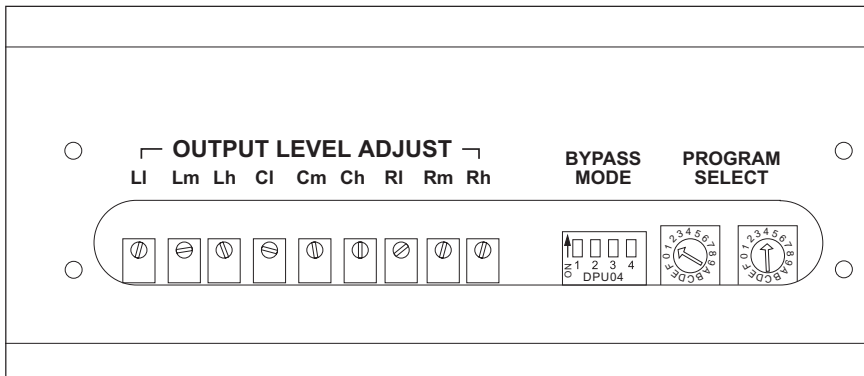

Selecting Speaker Type

CAUTION: Incorrectly setting the Speaker Type selector switches can damage speakers. Verify settings before activating amplifiers.

- 1) Turn the amplifiers off.
- 2) Turn the XTD off.
- 3) Use the chart in the Appendix to determine the setting that matches your speakers. If your speakers are not listed, please contact USL.
- 4) Use a small screwdriver to set the rotary switches to the matching setting.
- 5) Set the Bypass Mode switches to match the speaker configuration, two-or-three-way. Up (or ON) is two-way; Down (or OFF) is three-way. All switches must be set the same way - either all Up or all Down.
- 6) Turn the XTD Volume pots fully counter-clockwise.
- 7) Set the Cinema Processor equalizer (or room equalizer) to “flat” (no gain or attenuation) for all channels.

Setting Input levels

- 1) Turn on the XTD (but not the amplifiers).
- 2) Use a Pink Noise generator or other 0dB reference signal in the Cinema Processor.
- 3) Note: The XTD is designed to accept signal levels up to +26dB (6.25V rms) with a 0dB reference of 300 mV rms.

- 4) Adjust the output level of the Cinema Processor Left Output Level Control until the Channel Signal Level LED on the XTD just turns yellow (The Signal Level LEDs will be Green \pm 0.5dB above or below 0dB, Yellow within \pm 0.5dB of 0dB, and Red when above +23dB and in danger of clipping)
- 5) Repeat for the Center and Right Channels.

Setting Output levels

Note: The XTD Volume Controls are factory-set fully counterclockwise (off or zero) for shipping to prevent accidental damage to your speakers.

- 1) Set up a Sound Pressure Meter, set to "C" weighting, and a Spectrum Analyzer in the audience area.
- 2) Turn on the Left Channel Low Frequency Amplifier. NOTE: The amplifier volume should be set as it would normally be set. Some facilities merely set the amplifier volume to maximum (or other standard level) to facilitate amplifier swap out.
- 3) Adjust the XTD Left Channel Low Frequency Volume pot until the Sound Pressure Level is approximately 80dB.
- 4) Turn off (or down all the way) the Low Frequency Amplifier.
- 5) If you are using a two-way system, skip the mid range adjustment and leave the mid volume fully counter-clockwise.
- 6) Turn on the Left Channel Mid Frequency Amplifier.
- 7) Adjust the XTD Left Channel Mid Frequency Volume pot until the Sound Pressure Level is approximately 80dB.
- 8) Turn off (or down all the way) the Mid Frequency Amplifier.
- 9) Turn on the Left Channel High Frequency Amplifier.
- 10) Adjust the XTD Left Channel High Frequency Volume pot until the Sound Pressure Level is approximately 80dB.
- 11) Turn on the Low, Mid, and High Frequency Amplifiers.
- 12) Re-adjust Left Channel volumes for the best flat response.
- 13) Repeat Steps 2-12 for the Center and Right Channels.
- 14) EQ the room per the Cinema Processor or room equalizer instructions (without further adjustment of the XTD).
- 15) Install the Access Panel Cover.

Emergency Bypass setup - None. Refer to Installation section.

Operation

Normal Operation

- **Power Switch** - During the first 15 seconds after the XTD is turned on, it will function in the Backup Mode and audio signals will be processed by the analog crossover. Once the system has stabilized and the firmware programs have been loaded, it will set itself to the configuration determined by the speaker selection switches.
- **Power LED** - Should be green indicating normal operation.
- **Crossover Presets** - DO NOT ADJUST WITH THE UNIT ON (see Alignment Section). The unit only recognizes changes when it is first turned on. Changing the switches while the power is on may result in an incompatible configuration that may not be noticed until the next time the unit is turned on.
- **Signal Level LEDs** - The three LEDs indicate the signal levels of the three input channels to the XTD as shown in the chart below. Note: 0dB = 300mV rms

LED Color	Signal Level	Signal Measurement
Off	No Signal	< -54dB
Green	Signal present	-54dB to -0.5dB
Yellow	Reference level	-0.5dB to +0.5dB
Green	Signal present	+0.5dB to +23dB
Red	Clipping	> +23dB

- Output Signal Level Adjustment - Should be already set (see the Alignment Section).

Bypass Operation

- **Backup power** - If the primary Power Supply fails the Power LED will be red, Contact USL. If the digital processing fails (or to check the processing) turn the Power Switch Off and the unit will go into Bypass mode, Contact USL
- **Backup Crossover Type** (Two-or-Three-Way) - Should be already set (see Alignment) Up (or On) is two-way; Down (or Off) is three-way.

Updating the Program and Crossover Files

Updating the XTD firmware requires special knowledge and training provided with update package, please contact USL.

Please make note of the firmware version number on the rear of the unit.

Appendix

Connector pinouts

Inputs	Right Output	Center Output	Left Output
(Right to Left)	(Right to Left)	(Right to Left)	(Right to Left)
Left Channel +	Low Band +	Low Band +	Low Band +
Left Channel -	Low Band -	Low Band -	Low Band -
Left Channel E	Low Band E	Low Band E	Low Band E
Center Channel +	Mid Band +	Mid Band +	Mid Band +
Center Channel -	Mid Band -	Mid Band -	Mid Band -
Center Channel E	Mid Band E	Mid Band E	Mid Band E
Right Channel +	High Band +	High Band +	High Band +
Right Channel -	High Band -	High Band -	High Band -
Right Channel E	High Band E	High Band E	High Band E
Chassis Gnd	Chassis Gnd	Chassis Gnd	Chassis Gnd

Crossover List

Speaker Manufacturer	Type	Switch A	Switch B	Bypass Switch
EAW	MC4953/MC4973	2	0	Off
EV 3 Way	Variplex	3	0	Off
JBL 3 Way	5672/5674	5	0	Off

Trouble Shooting

- There is very little that can go wrong with the XTD except a failure of the fuse. Any other instance such as activation of the backup power system may require servicing the unit by USL or trained technician.
- There are no user serviceable parts inside the unit.
- Updating the XTD firmware requires special knowledge and training provided with the update package, please contact USL. Please make note of the firmware version number on the rear of the unit.

Fuse replacement - Remove the power cord and pull out the fuse holder. Replace the fuse with the same type and rating. Reinstall the fuse holder making sure it is correctly oriented.

 **USL, Inc.**

Quality Cinema Products

© 2000 All Rights Reserved

Ultra*Stereo Labs, Inc.

181 Bonetti Drive

San Luis Obispo, CA, 93401 USA.

Telephone 805.549.0161

FAX 805.549.0163

e-mail: usl@uslinc.com