

FILM-TECH

THE INFORMATION CONTAINED IN THIS ADOBE ACROBAT PDF FILE IS PROVIDED AT YOUR OWN RISK AND GOOD JUDGMENT.

THESE MANUALS ARE DESIGNED TO FACILITATE THE EXCHANGE OF INFORMATION RELATED TO CINEMA PROJECTION AND FILM HANDLING, WITH NO WARRANTIES NOR OBLIGATIONS FROM THE AUTHORS, FOR QUALIFIED FIELD SERVICE ENGINEERS.

IF YOU ARE NOT A QUALIFIED TECHNICIAN, PLEASE MAKE NO ADJUSTMENTS TO ANYTHING YOU MAY READ ABOUT IN THESE ADOBE MANUAL DOWNLOADS.

WWW.FILM-TECH.COM

INSTALLATION AND TECHNICAL INFORMATION



The V3001 is a laser highly effective upgrade for white light or alternative red light optical soundtrack illuminators for 35mm projectors.

- Needs no preamplifier
- Straightforward installation – simply replaces the existing sound optics lens and exciter lamp
- Long life laser diode
- Compatible with conventional silver, high-magenta and cyan soundtracks
- Exceeds typical LED life
- Adaptors available for all common projectors
- Added protection from electrical noise – can be run off the cinema processor's power supply
- Offers drastically improved crosstalk and high frequency performance
- New lower operating voltage
- New optical chain ensures easy alignment

Future Projections Ltd

110 Friary Rd, London SE15 1PX, England.
Tel (+44) 020 7358 0606, Fax (+44) 020 7358 0909,
email: sales@fproj.com.

Registered in the United Kingdom #3797445. Copyright 2005 Future Projections Ltd

www.fproj.com

Contents;

1.0 Introduction and specifications

- 1.1 Specifications
- 1.2 Support
- 1.3 Warranty
- 1.4 Electrical noise – important note

2.0 Installation

- 2.1 Contents of kit
- 2.2 Installation prerequisites
- 2.3 Power supply and electrical connections
- 2.4 Physical installation
- 2.5 Alignment
- 2.6 Installing on a different projector

3.0 Troubleshooting

- 3.1 Maintenance

4.0 Ordering and spare parts information



Introduction

The v3001 is designed as a simple to install replacement for white light readers in 35mm projectors, to allow playback of Cyan Dye soundtrack films. It can also be used to upgrade first generation LED retrofit kits where greater reliability noise may be an issue. The unit performs well with all types of tracks, be they traditional black, high magenta or cyan dye.

The unit consists of a high stability laser diode and internal optical components, housed in a standard package. It is intended to replace the sound optics lens in an existing projector, and a variety of adaptor sleeves are available to fit most machines. Alternatively, a bracket is available to allow fitting to ANY projector where a standard cylindrical lens is not used (for example Kalee, Ernemann).

Because of the highly focused light emitted from the laser, the unit works with the existing mono or stereo solar cell already fitted to the projector, removing the need for a pre amplifier and increasing the gain of the system substantially.

Lasers can be powered from any 3.7VDC regulated source, including the cinema's stereo processor (via two small diodes to reduce 5V to 3.7V). The current drawn by the v3001 is small indeed, at around 35mA DC. No special power supply is needed, and in an emergency the unit will work off three 1.5V batteries or even a mobile phone charger.

1.01 Specifications

Type of illumination	Laser diode
Light output	650nm
Power requirements	3.7VDC, regulated, isolated from projector and xenon chassis'
Focus distance	5mm to film plane, 7mm to cell (approx)
Slit width adjustment	Outer edge vernier bolt and locknut
Rated life	10000 hours to 25000 hours
Warranty period	One year from shipping
Compatibility	Cyan, High Magenta, Black, Variable area, Variable density and other 35mm optical tracks

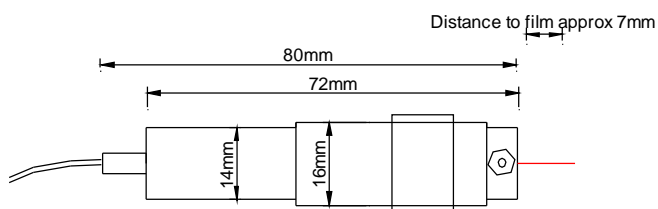

1.02 Support

We are there to help. Our web site, www.fproj.com, contains technical notices and information which may be useful. We are available by telephone, fax or email and out of hours our switchboard number will direct you to an emergency number.

1.03 Warranty

The V3001 is warranted to be free from defects in manufacture for one year from the date of shipping. If a failure is suspected, please contact us and get a returns authorization – note items returned without this will be sent back. If a problem occurs during the warranty period, we will repair or replace the unit (at our option) following return and evaluation in our office. This warranty covers only equipment supplied and return of the unit via surface post. We make no warranties beyond this and limit our liability to replacement or repair of the faulty unit. In the unlikely event of a failure it is recommended that the existing white light be retained for emergency installation.

Our warranty is based on the unit being installed by trained and competent persons using test gear as listed. It specifically excludes damage resulting from misuse, poor installation or electrostatic discharge, either cable or airborne (see notes on installation).

1.04 Electrical noise – READ THIS !

The laser diode within the V3001 is a CMOS devices and like any semiconductor device can be damaged by “wired” or airborne electrical noise. Projection rooms are full of electrical noise, coupling high current DC lines to the xenon lamp with an extremely high voltage AC emitted from the lamphouse ignitor – if the strike of the xenon is audible through the theatre sound system then this is one indication of certain noise.

The V3001 contains internal circuitry to help protect the unit against such noise, and by following the listed advise the unit will be further isolated from the noise source.

- If installing a **V2001**, ensure that the laser body is electrically isolated from the projector chassis. Ensure that the plastic sleeve is in position and that the grub screw to secure the laser has not penetrated this sleeve and made a connection. The V2001 body is connected to the positive voltage rail and this can also cause problems with older power supplies.
- If installing the **V3001**, we also recommend ensuring isolation from chassis also. Whilst the projector and lamphouse in your theatre are no doubt earthed, the high frequency and voltage of ignition and motor controllers invariably generates noise and this is radiated throughout the projectors steel chassis. (This can be demonstrated by attaching an oscilloscope probe to the projector chassis and striking the xenon lamp).
- Keep the power cables to the laser as short as possible, and use foil screened cable. The screen should be connected **ONLY** at the power supply end, and should be connected to a clean earth (not the projector chassis)
- Do not connect either the +ve or -ve rail of the laser or power supply to earth
- Install the diodes (supplied) near to the laser – this adds a further level of isolation
- Observe the correct laser polarity and check the operating voltage with an accurate meter
- Do not try and use existing power supplies – the V3001 kit comes complete with a power supply, use this. AC mains to this should be sourced from a clean supply and an earth with a wired connection to an electrical intake.
- A v2001 has a red label, whereas a v3001 has a blue label and a shorter DC cable.

1.0 Installation

2.1 Contents of kit

Each laser comes complete with a power supply, AC socket, diodes, crimp connectors and even screened cable for the power supply, as well as sleeves for the apt projector. Each unit is also shipped with delicious stick of Future Projections rock !

V3001 – KIT CONTENTS

		v3001 laser	Power supply, installation kit	Mounting bracket V3001BKT1	Adaptor sleeve V300118	Adaptor sleeve V300119	Adaptor sleeve V300120	Adaptor sleeve V300120E	Adaptor sleeve V3001205	Adaptor sleeve V3001208	Adaptor sleeve V3001205E	Adaptor sleeve V300121	Adaptor sleeve V3001215
V3001KIT18	Ernemann 15, Philips / Kinoton FP20, FP23, FP24, FP30, FP38, FP40, DP75	1	1		1								
V3001KIT19	Century, Simplex	1	1			1							
V3001KIT192	Westrex 2002, 2003, 5000	1	1			2							
V3001KIT20	Prevost	1	1				1						
V3001KIT20E	Meopta	1	1					1					
V3001KIT205	Fedi	1	1						1				
V3001KIT205E	Cinemecannica V4, V5, V8, V9, V10	1	1							1			
V3001KIT208	Klangfilm	1	1								1		
V3001KIT21	AGA	1	1									1	
V3001KIT215	Dresdner	1	1										1
V3001SPECIAL1	Ernemann 12, Kalee type 83, others	1	1	1	1								

Each kit contains

V3001	
Power supply, plug in type	
Crimp connector x 8	
Screened audio pair cable x 5m	
Green silicon sleeving x 100mm	
UK 13A flying socket	
1N4001 Diode x 4	
Installation manual	
Mains flex x 5m	
fproj.com rock !	

2.2 Installation prerequisites

Installation should be undertaken by an engineer familiar with cinema processors and A chain procedures, using the following equipment;

- Real time audio spectrum analyzer and leads to couple with the apt cinema processor
- Dual trace oscilloscope and connecting leads
- Test films – reference tone, pink noise, Left / Right crosstalk film, illumination test film, SMPTE buzz track
- Crimp tool and general hand tools

We estimate installation to take around two hours, including alignment.

Before installation commences, run a known good film in the theatre and evaluate the existing system.

2.3 Power supply and connection

This involves working with mains electricity and should be undertaken by trained personnel. Isolate all power before starting.

There are two options for supplying the laser;

1. Utilize the power pack supplied with the kit. This is recommended
2. Source the supply from the 5VDC rail of the cinema processor. This is a perfectly good power supply however using this can cause some confusion when fault finding.

In either case, the DC connections are the same.

If you are using the power pack, first wire up the 13A socket for the power supply. Connect this to a 220 – 240VAC clean supply – the connections in the socket are clearly marked. Use the mains cable supplied – **don't confuse this with the audio cable also supplied** (the mains cable is three core 0.5mm flex, with Brown, Blue and Green conductor insulation). It is possible to switch the AC supply of the laser on and off with the projector motor – do this via a spare contact on the motor switch or a set of relay contacts slaved off the projector motor.

Set the power pack to 4.5VDC.

Now connect the DC cabling to the laser. It is important to protect the DC cable from electrical noise. If the laser is to be located within a meter or so of the laser, you can connect the power supply directly to the diodes that feed the laser. Otherwise use the screened cable supplied and connect as follows.

The diodes offer the required voltage drop to operate the laser at 3.7V as well as tendering some isolation – depending on mains voltage you may require only one installed. Check the voltage on the laser – this should be as near as possible to 3.7V and never over 4V.

Laser DC connections

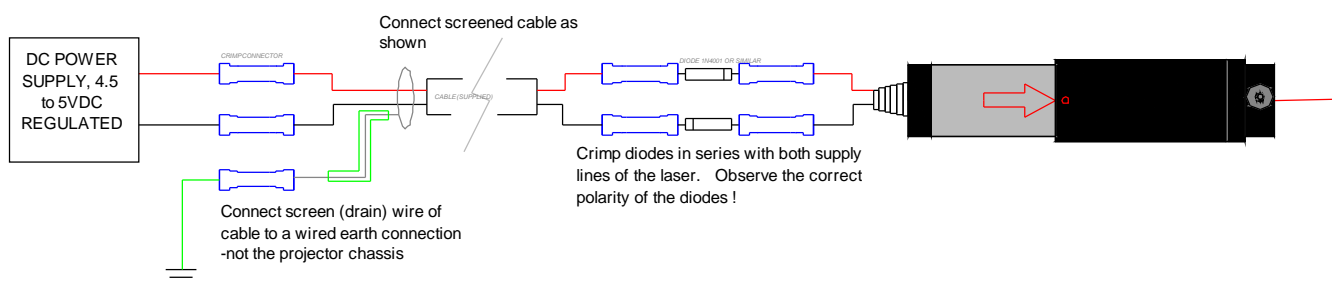

Reconnect the power and the laser should light up.

2.4 Physical installation

The laser replaces the existing sound optics lens.

First, Isolate all power and remove the projector's exciter lamp and sound optic lens – note that in some cases it is necessary to remove the sound drum to access this. Once removed, thoroughly clean the inner surface of the receptacle for the sound optic lens – the laser is a tight fit and this will make alignment easier.

Fit the adaptor sleeve over the laser body, locating it close to the where the laser is secured in the projector. Now install the laser and sleeve, with the arrow and slit width screw on the laser towards you (i.e. away from the projector chassis).

Locate the laser approximately 5mm from the film plane, and ensure that the existing solar cell is approximately 2mm behind the film plane. Check that the laser beam is hitting the cell.

Laser physical installation

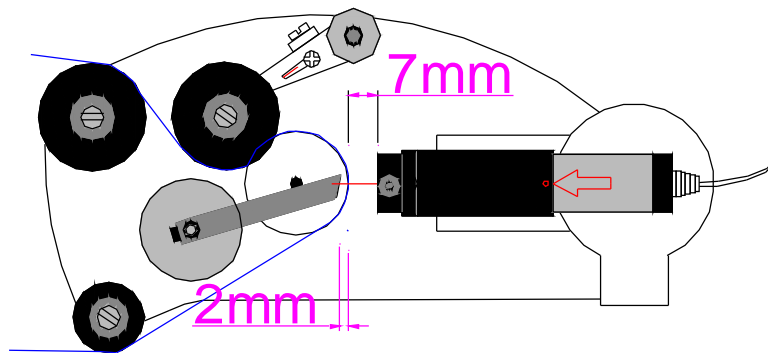

2.5 Alignment

Connect the RTA and oscilloscope to the cinema processor. Set the processor slit loss adjustments (HF gain) to minimum and the optical gain controls to around 20%. Clean the solar cell with a cotton bud and suitable cleaning fluid.

Coarse focus adjustment - Lace up and run PINK NOISE (Dolby Cat 69P or similar). Observe the RTA display – move the laser body in and out (towards and away from the screen) to achieve maximum high frequency gain. Rotate the laser a little to further achieve this.

Laser alignment

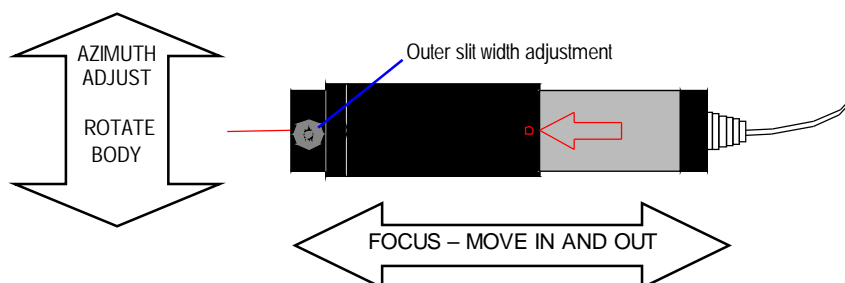

Coarse level adjustment - Lace up and run REFERENCE TONE (Dolby Cat 69T or similar). Adjust the cinema processor's optical gain controls in the usual manner.

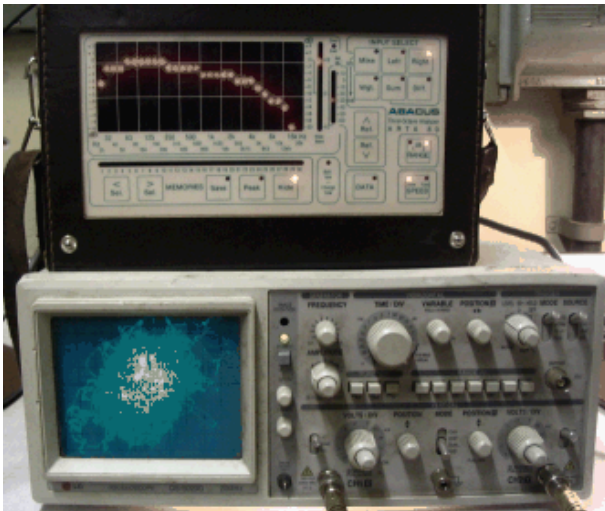

Poor focus and azimuth

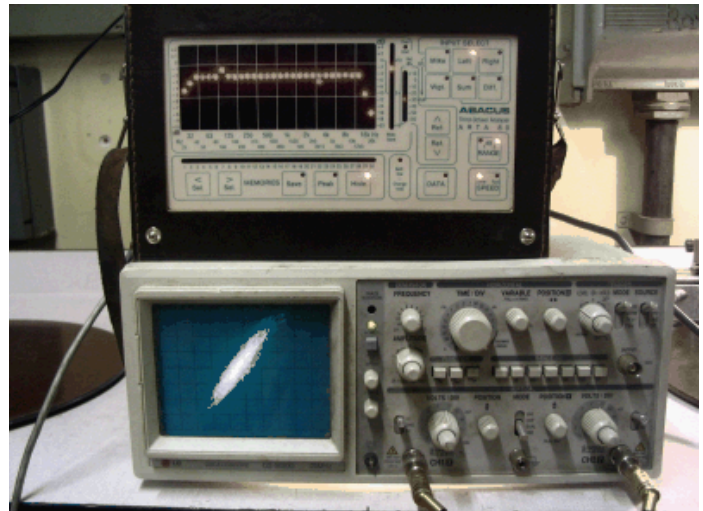

Good focus and azimuth

Slit width adjustment – Lace up and run BUZZ TRACK (SMPTE or similar). Listen for the low frequency tone - observe this on the oscilloscope or RTA. Adjust the film's scanning position in and out to the point where this low level tone disappears. Note that on some projectors the exciter lamp housing is moved and the film remains static. Now loosen the slit width locknut on the laser and gently adjust the slit width grub screw to the point where the high frequency tone of the Buzz Track disappears. Lock this adjustment.

Left / right adjustment – Lace up and run LEFT / RIGHT test film. Adjust the horizontal position of the cell to achieve equal and minimum crosstalk. If excessive crosstalk is apparent on *both* channels check the cell position relative to the film – it may need to be moved closer or further away from the film. At this stage we recommend that the connection of the cell be checked. With the loop running, slowly insert a card of some sort between the cell and the light source from the operating side of the projector – the right hand channel should fade out first, followed by the left.

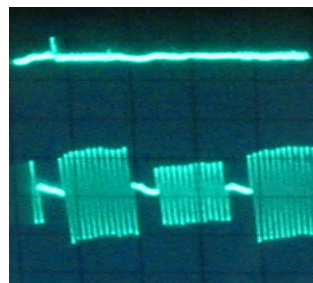

Cell out of adjustment

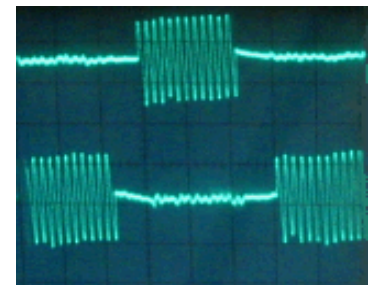

Cell adjustment OK

Azimuth adjustment - Lace up and run PINK NOISE (Dolby Cat 69P or similar). Set the oscilloscope to plot X vs Y. Gently rotate the laser body to achieve a straight diagonal line. We recommend using an adjustable spanner on the laser to increase accuracy of this adjustment.

Final focus adjustment – Still running PINK NOISE, observe the RTA display – again move the laser body in and out (towards and away from the screen) to achieve maximum high frequency gain. Try not to rotate the laser whilst doing this. Repeat this and the azimuth adjustment to achieve the best overall response.

Illumination check – Lace up and run Dolby Cat 556 illumination test film. Observe the RTA for the six separate frequency bands – any drop off on the outer bands indicates poor illumination. If drop-off is visible at the lower end of the spectrum, move the film position (as you did running Buzz track).

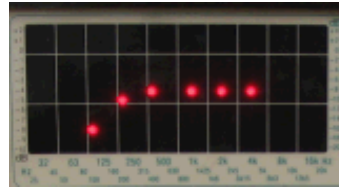

Poor illumination

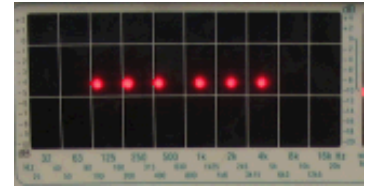

Good illumination

If the drop-off is at the high end of the spectrum, adjust the slit width grub screw. Following this you will need to repeat the cell adjustment with Left / Right test loops.

Processor adjustment - Lace up and run PINK NOISE (Dolby Cat 69P or similar). Observe the RTA display – adjust the processor’s HF gain / slit loss adjustment controls to achieve a flat response. Lace up and run REFERENCE TONE (Dolby Cat 69T or similar). Adjust the cinema processor’s optical gain controls in the usual manner.

NOTE – all adjustments interact with each other – to get best results we recommend repeating this procedure from “slit width adjustment” after changes are made.

Now lace up this week’s blockbuster, take a seat in the theatre and enjoy the enclosed stick of fproj.com rock !

2.6 Installation on a different projector

Some projectors do not use standard cylindrical sound optic lenses, and require additional measures to install a v3001 laser. In some cases it is simply a matter of choosing an adaptor to best fit the projector’s lens tube and adjusting as normal, however in other cases the exciter lamp and lens housing are not suitable. A bracket is available to install the v3001 directly onto the projector chassis – we have used these with success on Ernemann and Kalee projectors. Installation of this requires the removal of the old exciter lamp housing, drilling and tapping threads in the projector chassis and bolting the bracket on via long bolts or studded rod. Please contact us for advise on this – the job takes a few hours but can produce great results.

Some Kalee sound heads use a variety of condenser lenses in the optical A chain and can deliver variable results when upgraded. We recommend replacing the Kalee cell and optical arrangement with a standard stereo pick up designed for a Century machine or similar. Upgrading is a half day's work and involves drilling and tapping new mounting holes however final results can be fantastic. Please talk to us if you have a Kalee - installing the laser on top of the existing sound optics will certainly result in an improvement in sound and full cyan compatibility however to realize the potential of the laser you may need to upgrade some items.

Physical installation

The v3001SPECIAL1 kit is supplied with a bracket for mounting on the chassis of a projector where the existing sound lens is not a standard cylindrical unit, for example the Kalee or Ernemann soundhead. In these cases it is possible to remove the existing exciter lamp housing and fit the bracket directly to the projector or soundhead chassis. We recommend the following procedure;

1. Remove the existing exciter lamp housing and isolate it's electrical connections
2. Install the bracket mounting base so that the laser is at right angles to the film. The bracket can "clasp" the laser on either the rear, 16mm diameter section (use a sleeve supplied with the bracket) or via an 18mm laser sleeve at the front of the laser. We recommend that the later method is used as it is advantageous to clamp the laser as close to the film plane as possible.

Ernemann 7, 8, 9, 10, 12 – the existing M6 tapped hole in the projector chassis (formerly used to hold the exciter lamp housing in place) is ideally placed to take the upper hole of the new mounting bracket – tap a thread and fit a M4 or M5 bolt to the lower hole. The upper hole will require a longer M6 bolt (20mm). The hole in the bracket also needs enlarging. Contact us for help.

Alignment of the SPECIAL1 kit

As well as the usual adjustments, the flexible nature of the SPECIAL1 bracket allows further adjustment. We recommend the following method;

1. Lace up and run Cat69T reference tone and rotate the laser vertically to achieve maximum level.
2. Perform coarse focus and azimuth as normal
3. Run BUZZ TRACK and adjust the laser towards and away from the projector chassis to eliminate the low level tone. Now adjust the slit width screw to eliminate the high frequency tone.
4. Continue with all other adjustments as described in the "alignment" section of this manual

2.0 Troubleshooting

The v3001 is a sealed unit and should give years of good service.

Can't achieve good results when running Cat556 – if good illumination across the film plane is not possible, it could be that the cell is too close to the film. Laser light behaves differently to white light and the focal plane is slightly different. Try moving the cell further away from the film.

Poor HF response – check that the laser's internal alignment has not been disturbed. The red arrow on the side of the laser should point directly at the small grub screw on the front body. This can be aligned by eye and then checked in a similar manner as setting the azimuth

Laser cuts off when projector / xenon etc are switched – this is a sure sign of electrical noise reaching the laser. Review the power supply and connections

3.01 v3001 Maintenance

Cleaning – the lens of the laser and the stereo cell should be cleaned regularly with a cotton bud moistened with a little alkali based cleaning solution (e.g. water based window cleaner).

Level adjustments - The v3001 is a sealed unit and following installation no adjustments are required. The output of the laser degrades at a far slower rate than the output of a white light or LED, so reference level adjustments (Dolby tone) should seldom be required. We recommend that these levels are checked every three months or so. If more frequent adjustments are required please contact us.

4.0 Spare Parts and Ordering Information

V 3001	Laser emitter, bare, no sleeve or power supply
V300118	Sleeve V3001 /V2001 laser, 18mm
V300119	Sleeve V3001 /V2001 laser, 19mm
V300120	Sleeve V3001 /V2001 laser, 20mm
V3001205	Sleeve V3001 /V2001 laser, 20.5mm
V3001205E	Sleeve V3001 /V2001 laser, 20.5mm eccentric
V3001208	Sleeve V3001 /V2001 laser, 20.8mm
V300120E	Sleeve V3001 /V2001 laser, 20mm eccentric
V300121	Sleeve V3001 /V2001 laser, 21mm
V3001215	Sleeve V3001 /V2001 laser, 21.5mm
V3001BKT1	Bracket for installation of V3001 laser, needs 18mm sleeve on laser
V3001KIT18	Laser upgrade kit, with V3001, diodes, power supply / socket and laser sleeve 18mm
V3001KIT19	Laser upgrade kit, with V3001, diodes, power supply / socket and laser sleeve 19mm
V3001KIT192	Laser upgrade kit, with V3001, diodes, power supply / socket and laser sleeves 2 x 19mm
V3001KIT20	Laser upgrade kit, with V3001, diodes, power supply / socket and laser sleeve 20mm
V3001KIT205	Laser upgrade kit, with V3001, diodes, power supply / socket and laser sleeve 20.5mm
V3001KIT205E	Laser upgrade kit, with V3001, diodes, power supply / socket and laser sleeve 20.5mm eccentric
V3001KIT208	Laser upgrade kit, with V3001, diodes, power supply / socket and laser sleeve 20.8mm
V3001KIT20E	Laser upgrade kit, with V3001, diodes, power supply / socket and laser sleeve 20mm eccentric
V3001KIT21	Laser upgrade kit, with V3001, diodes, power supply / socket and laser sleeve 21mm
V3001KIT215	Laser upgrade kit, with V3001, diodes, power supply / socket and laser sleeve 21.5mm
V3001KITSPECIAL1	Laser upgrade kit, with V3001, diodes, power supply, 18mm sleeve and bracket for mounting on other projector (hardware not included)
V3001PSU1	Power supply, plug in, 4.5V for V3001 / V2001 lasers (note V3001 needs diodes)
V3001PSU2	Highly regulated power supply for direct connection to V3001 lasers
V3001SKT	UK 13A socket for V3001 / V2001 power supplies