

Film-Tech

The information contained in this Adobe Acrobat pdf file is provided at your own risk and good judgment.

These manuals are designed to facilitate the exchange of information related to cinema projection and film handling, with no warranties nor obligations from the authors, for qualified field service engineers.

If you are not a qualified technician, please make no adjustments to anything you may read about in these Adobe manual downloads.

www.film-tech.com

PANALOGIC

CA2000

*CINEMA AUTOMATION SYSTEM
OPERATION MANUAL*

SOFTWARE VERSION 1.15+

PANALOGIC CORPORATION PTY LTD

*GROUND FLOOR, 44 CARRINGTON ROAD
CASTLE HILL NSW
2154 AUSTRALIA*

*Phone - 612 9894 6655
Facsimile - 612 9894 6935*

www.panalogic.com

CONTENTS

INTRODUCTION	1.1
DESCRIPTION OF CONTROLS	2.1
SYSTEM SETUP	3.1
AUTOMATION OPERATION	4.1
AUTOMATION PROGRAMMING	5.1
INSTALLATION	6.1
APPENDIX	7.1

THE PANALOGIC CA2000 AUTOMATION SYSTEM

OVERVIEW

The Panalogic CA2000 automation system provides complete and comprehensive control of all cinema electronic and electrical equipment. The RC140 control panel contains all of the controls necessary to operate all of the equipment in a single cinema. The CA2000 is similar in concept to the old pin matrix automation systems in that a program is divided into rows of switches (or pins) which determine what happens at each step in the program. An external pulse (such as a foil sensor on the projector) is used to move the program from one row down to the next row. A major difference however between a pin matrix system and the Panalogic automation system is that the switching is controlled by computer rather than by using pins. The Panalogic CA2000 supports two projectors installed in one cinema and can interlock easily with other cinemas.

It is possible to set up 10 different programs. The 10 programs are called **SHOWS**. Each show can be made up of one or more **SEGMENTS** and each Segment can consist of up to 16 **EVENTS**. An Event is a single step in the program and is equivalent to one row in a pin matrix system. Each Event stores the settings for all of the switches that control the equipment in the cinema, the sound format selection and the volume settings.

Each Event has a programmable **TRIGGER** setting that determines what will cause the Event to take place. This can be one of three film foil cues, an on slide number or last slide cue from the slide projector, a time delay after the previous Event or a manual cue. An Event can be triggered manually by pressing the **NEXT EVENT** button on the control panel. (This is handy if you have forgotten to place a foil cue on the film, or if you want to pre-empt a cue). It is also possible to step backwards in a program if necessary and to pause and re-start a Show. The system can be programmed to use just one foil cue position, two positions or all three for compatibility with other screens in a complex that may use an older two or three cue automation system.

Shows can either be started manually, set to start at a specific time, by setting a start time and date up to 21 days ahead using Session Programming or by an external host computer running 'Panamation' software. The start time can be set in increments of one minute, when a start time is set a countdown is displayed showing exactly how long until the Show starts.

The CA2000 automation is a fully modular system allowing considerable flexibility for installation in a variety of situations. The control panel can be mounted in any convenient position and some distance from the relay cards using only a 4-wire connection between them. The CA2000 also provides direct serial control of the Panastereo CX230 booth monitor including digital real time display of auditorium volume levels on the automation control panel.

The CA2000 can be interfaced with a variety of external equipment using standard RS232 protocol including Panastereo cinema processors. New serial interface modules are being added to the CA2000 software as more serially controllable equipment becomes available. Check with your distributor for the latest software update to control your serial equipment.

DESCRIPTION OF CONTROLS

CONTROL PANEL LAYOUT

The Control panel is divided into 4 main areas.

The central area around the LCD screen is the equipment control area. There are six control keys across the bottom. These keys select the equipment control screens and the menu screen. Surrounding the screen are ten “softkeys”, these keys change their function depending upon which screen is displayed at the time.

The left area contains the automation controls. At the top are the Show select buttons and at the bottom are the Show control buttons.

On the right hand side of the LCD screen are the sound processor volume and mute controls.

To the far right, a separate area contains the monitor volume control and sound level meter for the Panastereo CX230 cinema monitor.

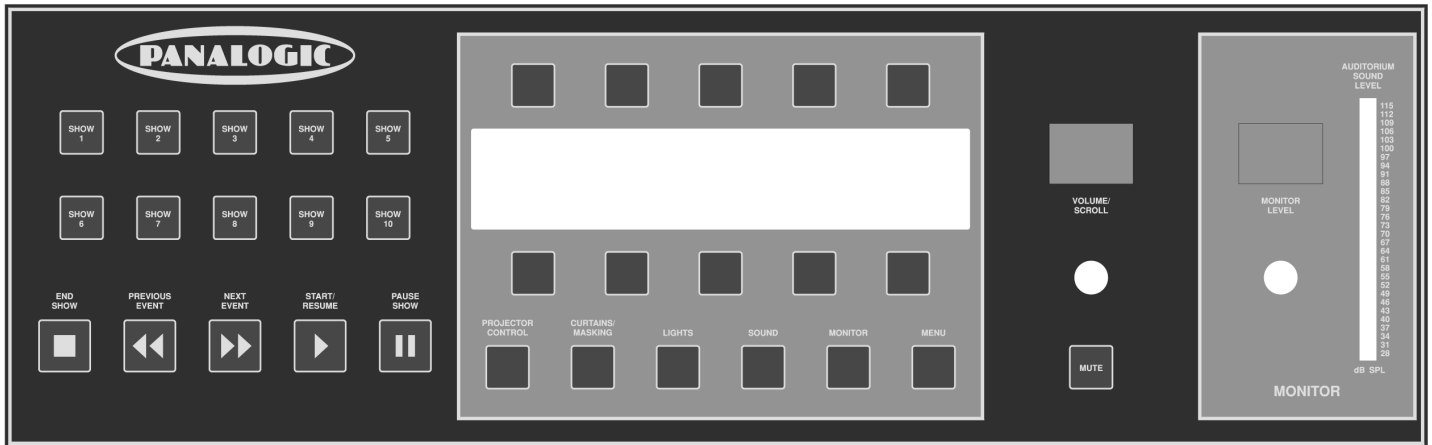

AUTOMATION CONTROL SECTION

EQUIPMENT CONTROL SECTION

SOUND PROCESSOR
VOLUME & MUTE

MONITOR
VOLUME & METER

CA2000 CONTROL PANEL

INITIALISING SCREENS

On powering up the Panalogic CA2000 Automation, the following screen will be created character by character, this will take around five seconds whilst the system performs self checking and initialisation, both volume displays will be displaying zeros.

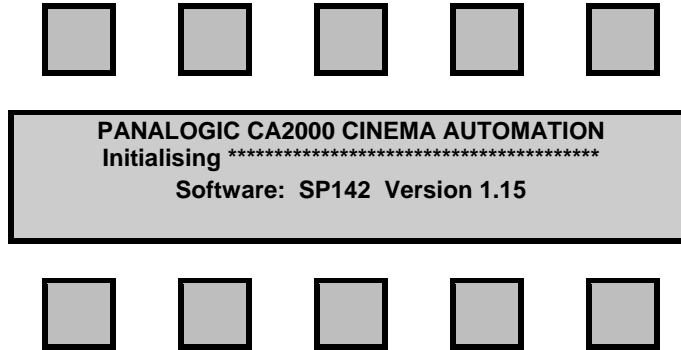

When initialisation is complete the next screen is displayed:

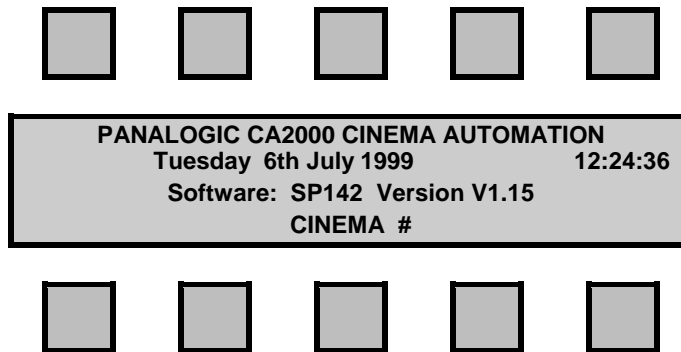

This screen displays the current date and time, shows the software version that is currently installed and displays the cinema number. The Panalogic Automation system is now ready to use.

THE MAIN SCREEN

The MAIN SCREEN displays the current date and time. The main screen looks like this:

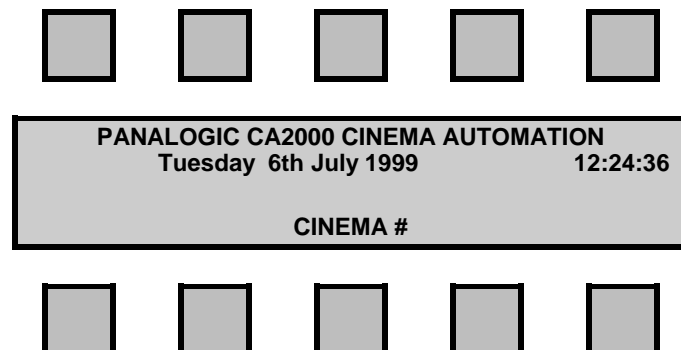

In the main screen, the softkeys have no effect.

THE PROJECTOR CONTROL SCREEN

The **PROJECTOR CONTROL** key will display the following screen:

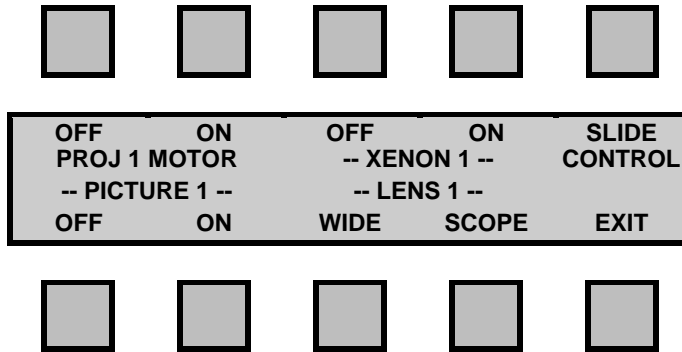

Pressing the **PROJECTOR CONTROL** key again will change the screen to the Projector 2 control screen for use in dual projector situations. If this feature is required, Options A Switch 8 needs to be set. Please refer to the installation section for further information.

The softkeys control the projector's functions and lens turret position. Pressing the keys will turn the function on or off. The current setting for each function will be flashing.

The **SLIDE CONTROL** softkey displays the SLIDE CONTROL screen.

The **EXIT** softkey will return you to the main screen.

THE SLIDE CONTROL SCREEN

The **SLIDE CONTROL** screen is accessed from the PROJECTOR CONTROL screen.

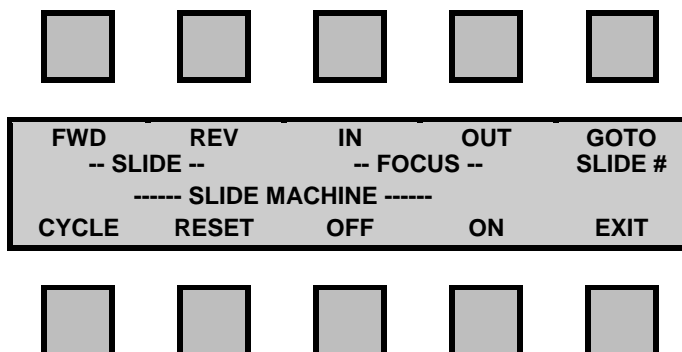

The top softkeys control the slide machine's slides and lens focus. The bottom softkeys control the slide machine's lamp, shutter, and the carousel's return to zero. The REV, FOCUS, GOTO SLIDE#, CYCLE and RESET softkeys only work with serially controlled slide machines such as the Kodak Ektapro 5000.

The **FWD** softkey will advance slides on both serially and parallel controlled slide machines. Each press of this key will advance to the next slide in the carousel.

The **REV** softkey will revert to the previous slide on serially controlled units only. Each press of the key will go back to the previous slide in the carousel.

The **FOCUS IN** and **OUT** softkeys only work with serially controlled slide machines. Press either key once to begin lens movement toward or away from the screen. Press the key a second time to stop the movement once focus has been achieved.

The **GOTO SLIDE #** softkey accesses the Goto Slide number feature, this allows the user to bring up any slide in the carousel by simply entering the slide number.

The **CYCLE** softkey will allow you to 'Cycle' through a number of slides, the Volume / scroll knob sets the number of slides and the Monitor / scroll knob sets the time between slides.

The **RESET** softkey only works with serially controlled slide machines and will turn on the slide projector lamp and cooling fan, reset the carousel to the zero slide position and sets the status of the slide machine to 'ON'. If a slide is in the zero position it will also open the shutter.

The **OFF** and **ON** softkeys work with both serially and parallel controlled slide machines.

For serially controlled units: The **OFF** softkey will close the shutter, turn off the lamp and after a delay of 30 seconds, put the machine into standby mode (turn off the cooling fan). The **ON** softkey will take the slide machine out of standby mode (turn on the cooling fan), turn on the lamp and open the shutter. For parallel controlled units: These softkeys will turn the slide machine on or off.

The **EXIT** softkey will return you to the main screen.

GO TO SLIDE NUMBER SCREEN

Pressing the **GOTO SLIDE#** softkey causes the main volume control to be set to scroll mode, indicated by two dashes (--) in the volume display box. The following screen is displayed...

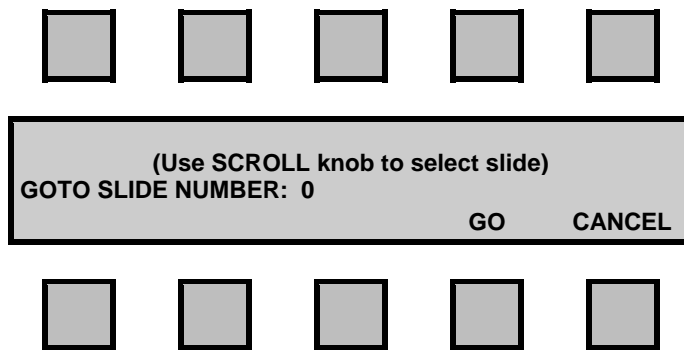

Use the Scroll control to select the particular slide that you would like to be displayed.

If the slide machine is on, pressing the **GO** softkey after the slide number is selected will cause the slide machine to go to that slide and project it. If the slide machine is off, it will be automatically turned on before it goes to the selected slide. The slide number will remain in memory until the unit is powered off; this is for convenience so that you do not have to continually call up the same slide number while programming.

The **CANCEL** softkey will cause the slide select to be aborted and exit to the Slide Control screen.

Note: The GOTO SLIDE # feature will only work on serially controlled slide machines.

CYCLE SLIDES SCREEN

Pressing the **CYCLE** softkey causes both the main volume control and the monitor volume control to be set to scroll mode, indicated by two dashes (--) in the volume display windows. The following screen is displayed...

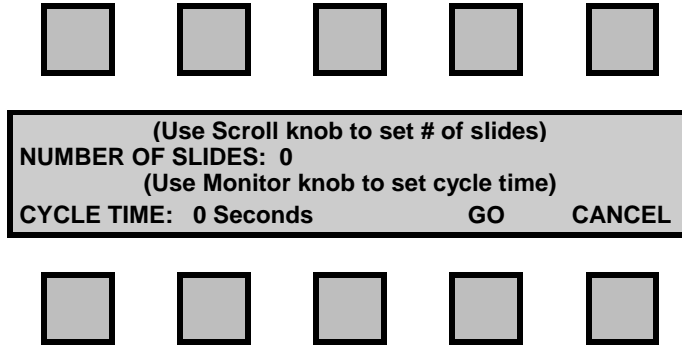

Use the Scroll control to select the number of slides to cycle. Use the Monitor volume control to set the cycle time (the time delay between slides) in seconds.

If the slide machine is on, pressing the **GO** softkey after the number of slides and the cycle time have been selected will cause a slide forward command to be sent to the slide machine every few seconds depending on the cycle time. The number of slide forward commands that are sent will depend on the Number of Slides setting. If the slide machine is off, this command will have no effect.

The **CANCEL** softkey will cause the cycle function to be aborted and exit to the Slide Control screen.

THE CURTAINS/MASKING SCREEN

The **CURTAINS/MASKING** key will display the following screen:

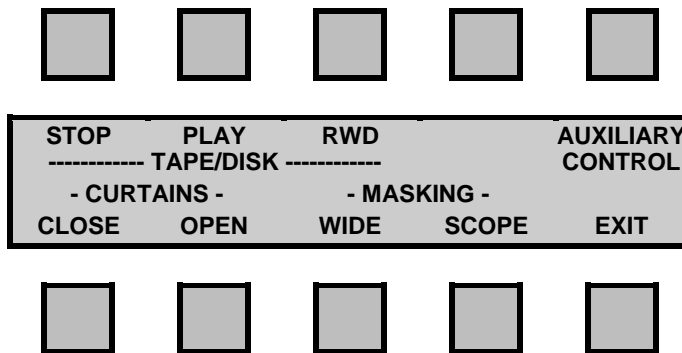

The top row of softkeys control the Tape machine or Mini-Disk Player used for the slide show and allows access to the auxiliary relay control panel. The bottom row of the screen contains the curtain and masking controls.

The **STOP** softkey only controls serially controlled Mini-Disk Players.

The **PLAY** and **RWD** softkeys control both serially and parallel controlled players and tape machines.

The **OPEN** softkey will open the curtains and the **CLOSE** softkey will close the curtains if installed.

The **WIDE** softkey will close the masking and the **SCOPE** softkey will open the masking. The masking is also controlled by the lens position. If during a show, the lens is changed, the masking will follow. The separate masking keys are provided so that the masking can be set differently from the lens, for example, during a slide presentation.

The **AUXILIARY CONTROL** softkey displays the AUXILIARY CONTROL screen.

The **EXIT** softkey will return you to the main screen.

THE AUXILIARY CONTROL SCREENS

The **AUXILIARY CONTROL** screens are accessed from the CURTAINS/MASKING screen. There are 8 auxiliary functions available, when the auxiliary control section is first accessed there will be four functions displayed, labels may differ to the ones shown.

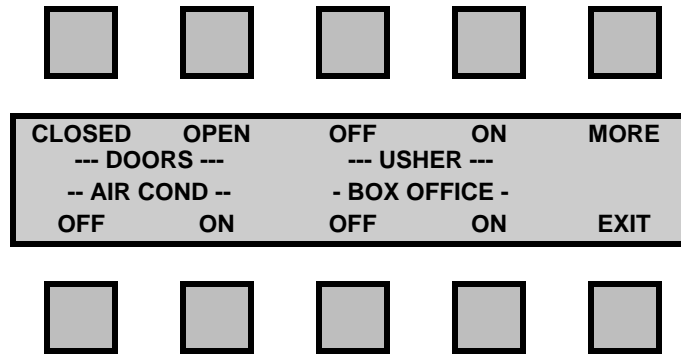

Pressing the **MORE** softkey will display the following screen and give access to the next 4 auxiliary controls.

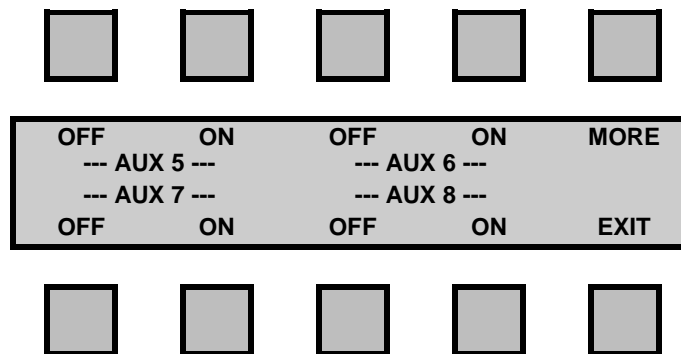

The softkeys for both auxiliary screens work the same as the functions in the projector function screen, with each auxiliary function having an 'ON' and 'OFF' softkey. The current setting for each auxiliary function will be flashing. The **MORE** softkey returns to the previous auxiliary screen.

The labels in both auxiliary screens can be changed to represent the function that they are used for eg. Usher, Box Office, Air Cond. etc. This is done in System Setup and is discussed later. The **EXIT** softkey will return you to the main screen from either auxiliary screen when pressed.

THE LIGHTS SCREEN

The **LIGHTS** key will display the following screen:

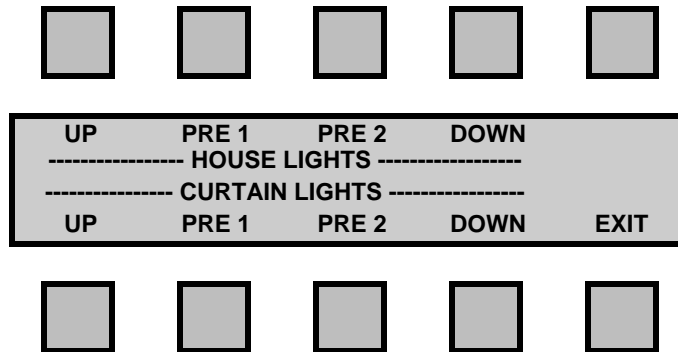

The upper half of the screen controls the House light's dimmer and the lower half controls the Curtain or Stage light's dimmer. There is provision for dimmers with up to two preset levels as well as fully up and fully down. The selected level for each dimmer will be flashing.

If using serially controlled dimmers, the levels of the presets (including up and down) and fade rates can be set by the user to a desirable level. The dimmer preset screen is accessed from the System Setup Menu; this is discussed in the System Setup chapter.

The **EXIT** softkey will return you to the main screen.

THE SOUND SCREEN

The **SOUND** key will display the following screen:

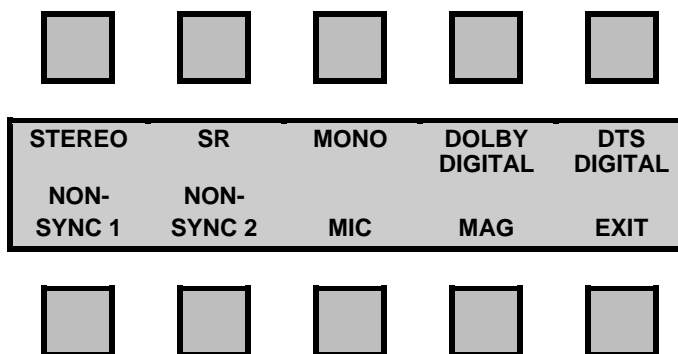

This screen controls the sound format selection of the sound processor. Whilst all the formats displayed are available with Panastereo processors, not all of the formats are supported by competitor's processors. The format currently selected will be flashing. Both Digital softkeys will 'pulse' the digital relay for parallel controlled sound processors.

The **EXIT** softkey will return you to the main screen.

THE MONITOR SCREEN

The **MONITOR** key will display the following screen:

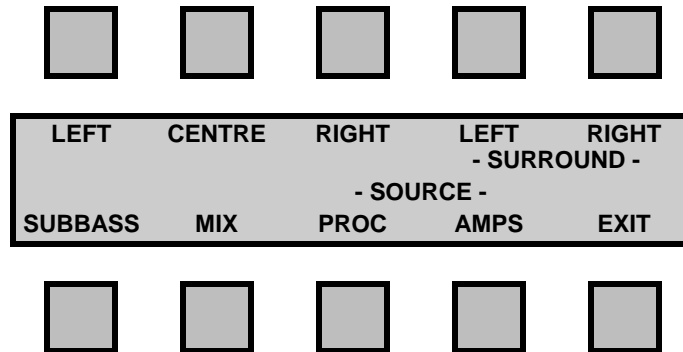

The softkeys control the output of a CX230 monitor unit or the internal monitor of any Panastereo processor.

The **MIX** softkey selects a mix of left, centre and right channels.

The **AMPS** and **PROC** softkeys select either the outputs from the amplifiers (**AMPS**, this feature only available with a CX230) or the outputs from the sound processor (**PROC**). The softkeys for this screen only work if a Panastereo CX230 monitor or Panastereo Cinema Sound Processor is installed. If being installed into an existing cinema with a Panastereo Processor a software upgrade may be necessary, for further information please contact your Panalogic dealer.

The **EXIT** softkey will return you to the main screen.

THE MENU SCREEN

The **MENU** key will display the following screen:

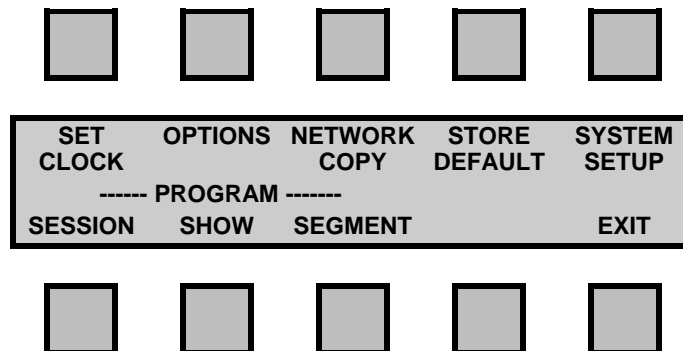

The **SET CLOCK** softkey accesses the clock set screen, the **OPTIONS** softkey accesses the user options screen, the **NETWORK COPY** softkey accesses the UPLOAD / DOWNLOAD screens for memory transfer between linked CA2000 units and the **SYSTEM SETUP** softkey accesses the system setup menu. These softkeys along with the **STORE DEFAULT** softkey are discussed in the System Setup Chapter in detail.

The PROGRAM softkeys **SESSION**, **SHOW** and **SEGMENT** are used to program the system, each of these softkeys are discussed in the Automation Programming Chapter in detail.

The **EXIT** softkey will return you to the main screen.

THE VOLUME CONTROLS

The **VOLUME/SCROLL CONTROL** controls the volume of the attached sound processor, except in some system setup and programming modes when it acts as a SCROLL control.

The volume level is indicated by the numeric display directly above the control. Level 7.0 corresponds to standard Dolby fader level 7 (85dB).

When the Volume/Scroll control is in "SCROLL" mode, the volume indicator changes to two dashes (– –) to indicate that the control is in scroll mode.

The **MONITOR VOLUME CONTROL** controls the volume of the Panastereo CX230 monitor unit if one is installed or the monitor volume of a Panastereo Cinema Sound Processor. It also controls a variable DC voltage that can be used to control any item of equipment that uses voltage control.

If a CX230 monitor is installed, the auditorium sound level is displayed on the **AUDITORIUM VOLUME** bargraph to the right of the MONITOR VOLUME CONTROL. The bar graph is calibrated in dB SPL and gives an accurate indication of sound levels in the auditorium provided the monitor has been correctly installed and aligned.

THE MUTE CONTROL

The **MUTE CONTROL** is located directly below the VOLUME/SCROLL CONTROL. This key toggles the sound processor MUTE function ON and OFF.

If MUTE is active the numeric volume indicator will flash, indicating that the attached sound processor is currently MUTED.

Selecting any sound format while in MUTE will select the requested sound format and turn the MUTE 'OFF'.

SYSTEM SCREEN FLOW CHART

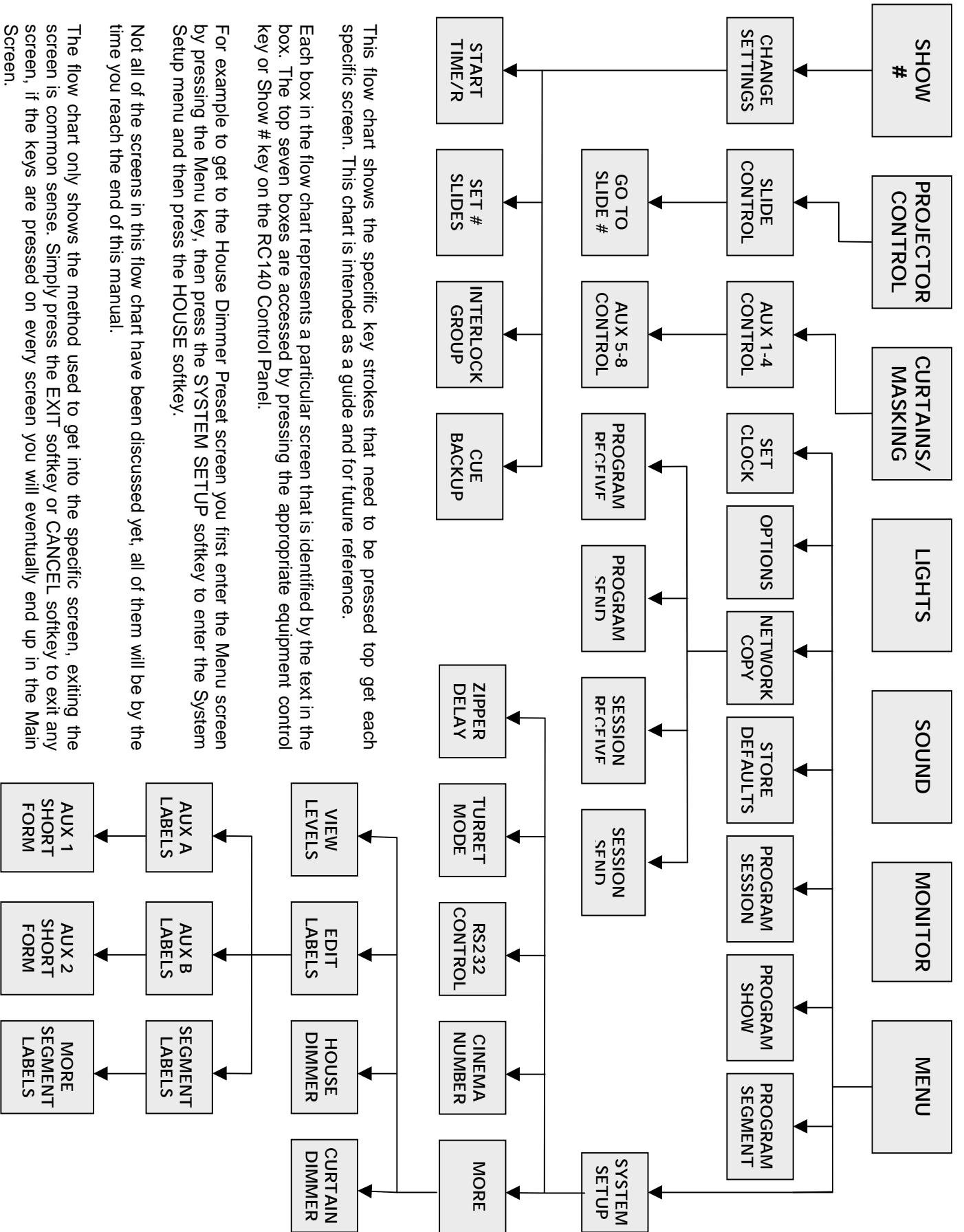

This flow chart shows the specific key strokes that need to be pressed top get each specific screen. This chart is intended as a guide and for future reference.

Each box in the flow chart represents a particular screen that is identified by the text in the box. The top seven boxes are accessed by pressing the appropriate equipment control key or Show # key on the RC140 Control Panel.

For example to get to the House Dimmer Preset screen you first enter the Menu screen by pressing the Menu key, then press the SYSTEM SETUP softkey to enter the System Setup menu and then press the HOUSE softkey.

Not all of the screens in this flow chart have been discussed yet, all of them will be by the time you reach the end of this manual.

The flow chart only shows the method used to get into the specific screen, exiting the screen is common sense. Simply press the EXIT softkey or CANCEL softkey to exit any screen, if the keys are pressed on every screen you will eventually end up in the Main Screen.

SYSTEM SETUP

SETTING THE TIME AND DATE

From the Main Screen press the **MENU** key.

The **SET CLOCK** softkey will display the following screen and is used to set the CA2000's real time clock.

DAY	DATE	MONTH	YEAR		
Monday	5th	May	2000		
12	24	36			
HOUR	MINUTE	SECOND	STORE	EXIT	

The time will be displayed and will update normally. To change any field press the appropriate softkey and the label will flash.

For example, press the **DATE** softkey and the DATE label will flash. To change the date, turn the Volume / Scroll knob. You can turn the SCROLL control in either direction to increase or decrease the date. When you have the correct date press the **STORE** softkey to save the setting. Set the other fields the same way.

IMPORTANT: Be sure to press the STORE softkey after each field is set. If you go directly to another field without pressing the STORE softkey the last field that you changed will not be saved.

If the CA2000 is connected to a PC running Panamation V1.36 or greater the correct date and time can be downloaded to all cinemas simultaneously, this ensures that all cinemas clocks are in sync. Please consult the Panamation help file for further instructions

The CA2000 clock tracks leap years but not day light saving (or summer) time.

Press the **EXIT** softkey when the date is correct.

THE DEFAULT SETTINGS

The DEFAULT SETTINGS are the settings (or state) of all of the equipment controls when the cinema is not running a show (session). Usually, this would include the projector turned off, slide machine off, curtain closed, house lights up and the sound processor selected to Non Sync 1 to allow background music to play.

In other words, these are the equipment settings that are used in-between sessions.

The DEFAULT SETTINGS are used by automation system for several tasks:

1. When a Show is paused by the projectionist, the automation reverts to the Default Settings.
2. When programming, the Default Settings are used as a starting point, each time we begin to program a new Segment.

Before storing the Default Settings it is first necessary to check that all of the equipment control switches are set exactly as they would be when a show is not running.

Check each of the PROJECTOR CONTROL, SLIDE CONTROL, CURTAINS/MASKING, AUXILIARY RELAYS, LIGHTS and SOUND screens in turn to check all of the settings. Change any settings that are incorrect as you go.

When you are satisfied that all of the settings are correct, press the **MENU** key to enter the MENU screen.

SET	OPTIONS	NETWORK	STORE	SYSTEM
CLOCK		COPY	DEFAULT	SETUP
----- PROGRAM -----				
SESSION	SHOW	SEGMENT		EXIT

Now press the **STORE DEFAULT** softkey and the following screen will appear for 2 seconds:

Default Settings Stored!!!

This indicates the Default Settings have been stored. You can now press **EXIT** to return to the Main screen.

For more information on how to program the default settings, please refer to the default settings tutorial found at the end of this chapter.

SETTING THE CINEMA NUMBER

The CA2000 system requires that when cinemas in a complex are connected together, each must have a different number for the correct operation of interlocking and data exchange between cinemas.

Our Windows based software applications “Panamation” and “Panacomm” also use the cinema numbers for data exchange.

To set the cinema number, it is necessary to enter the SYSTEM SETUP menu. This is accessed by first pressing the **MENU** control key and then pressing the **SYSTEM SETUP** softkey.

The System Setup screen looks like this:

SYSTEM SETUP				MORE
ZIPPER	TURRET	RS232	CINEMA	
DELAY	MODE	CONTROL	NUMBER	EXIT

Press the **CINEMA NUMBER** softkey and the screen will change to:

SYSTEM SETUP	
Set Cinema Number: 0	
OK	CANCEL

Use the ‘Volume / Scroll’ knob to set the correct cinema number and press the **OK** softkey when the correct number is displayed.

SETTING THE USER OPTIONS

The User Options allow a choice of operating modes for the automation system.

From the Main Screen press the **MENU** key.

The **OPTIONS** softkey will display the following screen:

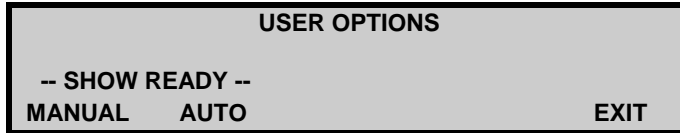

The currently selected option will be flashing.

SHOW READY MODE

The Show Ready options apply to running programmed Sessions.

MANUAL (default option) - When a Show ends, the system display reverts to the main screen. Before another show can be run, a Show # button must be pressed to place the system in Show Ready mode.

AUTO - When a Show ends and another session is pending (programmed to follow), the system automatically goes into Show Ready mode, so it is not necessary to press a Show # button for the next session to run.

SETTING THE ZIPPER CLOSE DELAY

The system provides for automatic closing of the zipper during lens changes, a feature not provided by most projector manufacturers. This feature eliminates the need to splice in black film at each lens change point to avoid picture distortion and spurious light on the screen as the lens turret rotates.

The time that the zipper remains closed during a lens change can be set between 0 and 9.9 seconds, in increments of 0.1 of a second. This allows the zipper close time to be exactly matched to the rotation time of individual lens turrets.

To set the zipper close time, it is necessary to enter the SYSTEM SETUP menu. This is accessed by first pressing the **MENU** control key and then pressing the **SYSTEM SETUP** softkey.

The System Setup screen looks like this:

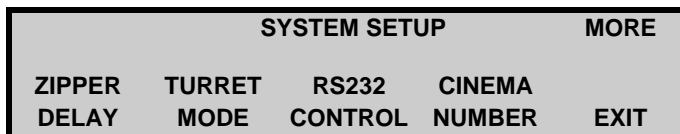

Press the **ZIPPER DELAY** softkey, the volume display will change to dashes to indicate that the control is in SCROLL mode and the screen will change to:

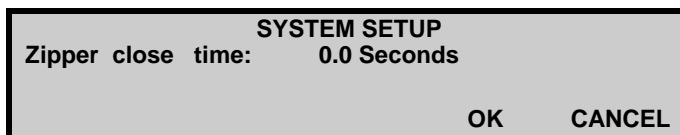

Rotate the scroll control until the desired time is displayed then press the **OK** softkey to save the new setting. If you change the setting and then decide to leave it as it was, press the **CANCEL** softkey and the changes will not be saved.

The screen will now revert to the System Setup screen.

Press the **EXIT** softkey to return to the Main Menu.

SETTING THE LENS TURRET DELAY

When the ZIPPER DELAY is set to a value other than zero, and a lens change occurs, the rotation of the lens turret will be delayed slightly to allow the zipper enough time to close.

The turret delay is adjustable from 0.25 seconds to 1 second in 0.25-second increments. The delay is set by Options B switches 3 and 4 on the AS101 relay card. See the INSTALLATION section at the end of this manual for instructions on how to set this delay.

SETTING THE TURRET OPERATING MODE

There are two ways to control lens changes:

1. Program each and every lens change so that each change is included as part of an Event.
2. Use a free-running Inboard Cue to initiate lens changes. Each time an Inboard Cue is encountered the lens will change. This method provides more flexibility when using many lens changes during a program or when moving prints between cinemas. Lens changes can still be programmed into the system as normal using this mode.

To select which mode you will use, it is necessary to enter the SYSTEM SETUP menu. This is accessed by first pressing the **MENU** control key and then pressing the **SYSTEM SETUP** softkey.

The System Setup screen looks like this:

SYSTEM SETUP				MORE
ZIPPER DELAY	TURRET MODE	RS232 CONTROL	CINEMA NUMBER	EXIT

Press the **TURRET MODE** softkey and the screen will change to:

SYSTEM SETUP		
INBOARD CUE	PROGRAM CONTROL	EXIT

To select Option 1 above press the **PROGRAM CONTROL** softkey OR to select Option 2 above press the **INBOARD CUE** softkey. The selected option will flash.

Press the **EXIT** softkey to return to the System Setup Menu.

ENABLING / DISABLING RS232 EQUIPMENT CONTROL

The CA2000 firmware includes serial protocols for a range of commonly used cinema peripheral devices, such as sound processors, slide machine, mini-disk players etc. It is necessary to tell the CA2000 which serially controllable peripheral devices you have connect to the system, this will ensure that the correct commands are sent to the connected devices.

Entering the SYSTEM SETUP screen and then pressing the RS232 CONTROL softkey accesses the RS232 Control screen. The following screen will be displayed. (Text may differ between software versions).

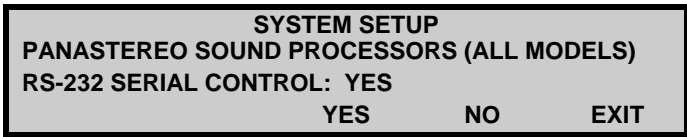

Once in the RS232 screen the volume / scroll knob will be in scroll mode, this is indicated by the two dashes (-- --) in the volume display. Simply scroll through the list of supported serially controlled devices and enable (or disable) any devices by pressing the YES (or NO) softkey as required.

The **EXIT** returns to the System Setup screen.

Please note: The list of supported serially controlled peripheral is growing all of the time, if the equipment that you wish to control is not in your CA2000 list please contact Panalogic Corporation Pty Ltd to see if the latest version of software supports that piece of equipment. A simple firmware upgrade might be all that you require, please contact your Panalogic equipment dealer for details.

DIMMER PRESET LEVELS

When the CA2000 is used with serially controlled lighting dimmers it is possible to set the levels of each preset as well as a fade rate.

The default settings for UP, PRESET 1, PRESET 2 and DOWN are 100, 70, 40 and 0% respectively, and the default fade rate setting is 10 seconds for a 100% to 0% fade.

From the System Setup Menu, press the **MORE** softkey to enter the next System Setup screen, then press the desired Dimmer Presets softkey, **HOUSE** or **CURTAIN**.

If the HOUSE softkey is pressed the screen will look like:

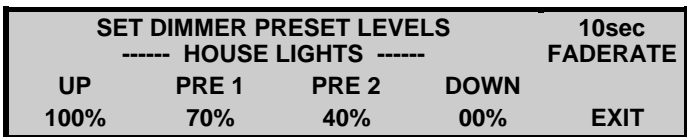

If the CURTAIN softkey is pressed the screen will look like:

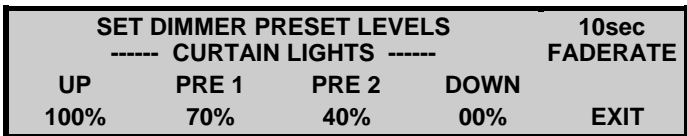

The softkeys in each screen function exactly the same way.

The lower softkeys **UP**, **PRE 1**, **PRE 2** and **DOWN** enable their appropriate levels to be set. When one of the level softkeys is pressed, the lights in the auditorium will instantly go to that level. The Scroll control is used to set the value anywhere from 00% to 100%. The lights will follow the level setting as it is being adjusted

The **FADERATE** softkey allows the fade rate to be set in seconds, the fade rate is the time taken to fade from 0% to 100%. Use the scroll control to set the Fade rate to a value anywhere from 1sec to 30sec. The Fade Rate will not effect the dimmers while in this setup screen, any changes made to the levels in this screen will be instantaneous. To view the fade time it is necessary to go to the lights screen and test by watching the light level fade as you switch between preset levels.

EXIT softkey stores the settings and exits to the System Setup screen.

Note: The CA2000 presumes that House lights are on Channel 1 and Curtain Lights are on Channel 2.

EDITING / CUSTOMISING LABELS

The CA2000 software enables the user to customise (edit) the labels in the 2 auxiliary screens as well as some of the Segment names.

To edit the labels, it is necessary to enter the **SYSTEM SETUP** menu. From this screen press the **MORE** Softkey, the following screen will be displayed:

SYSTEM SETUP				
VIEW	EDIT	DIMMER-	PRESETS	
LEVELS	LABELS	HOUSE	CURTAIN	EXIT

Editing the Auxiliary Labels

Press the **EDIT LABELS** softkey and the display will change to...(The text may be different.)

EDIT LABELS			
(Select a SCREEN to edit text)			
AUX 1	AUX 2	SEGMENT	EXIT

Select which screen you wish to edit, **AUX 1** or **AUX 2** and the display will change to... (Aux 1 shown)

_CLOSED	OPEN	OFF	ON	MORE
--- DOORS ---		--- USHER ---		
-- AIR COND --		- BOX OFFICE-		
OFF	ON	OFF	ON	SHORTFRM

There will be a cursor (a small bar) at the top left position. Change the text as required using the volume / scroll knob to move the cursor and the monitor knob to scroll through text above the cursor.

Press the **SHORTFRM** softkey to enter the shortform labels screen... (Aux 1 shown)

DOOR-OP	DOOR-CL	USHR-ON	USHR-OF	AIR-ON
AIR-OF	BOX-ON	BOX-OF		
				EXIT

Short Form labels are the labels as placed in the events when programming segments. Edit the SHORT FORM labels using the same method as the normal labels.

Pressing the **EXIT** softkey in any of the Edit Labels screens will exit to the System Setup screen.

Editing the Segment Labels

Enter the Edit Segment labels screen by pressing the **SEGMENT** softkey in the EDIT LABELS screen. The following screen will be displayed...

FEATURE1	FEATURE2	FEATURE3	FEATURE4
FEATURE5	FEATURE6	FEATURE7	FEATURE8
FEATURE9	FEATUR10	FEATUR11	FEATUR12
MORE			

The **MORE** softkey goes to the next segment labels screen...

FEATUR13	FEATUR14	FEATUR15	TRAILER1
TRAILER2	TRAILER3	TRAILER4	TRAILER5
TRAILER6	TRAILER7	TRAILER8	TRAILER9
EXIT			

The cursor (small bar) will be at the top left corner of the screen, change the text as required using the volume / scroll knob to move the cursor and the monitor knob to scroll through text above the cursor.

The **EXIT** softkeys returns to the system setup screen.

FAULT HANDLING

The CA2000 system can monitor and react to faults from three possible sources. These sources are Film Tension/Platter faults caused by loss of tension (usually due to a film break) or a head bind, Xenon faults caused by failure of the xenon or exciter lamp to ignite and a signal from the Fire Alarm Panel.

Note: Faults will not cause curtain, masking or lens changes.

FILM TENSION/PLATTER FAULTS

A Film Tension or Platter fault will only occur if the projector motor is started or is already running AND a film tension or platter fault exists. If a Show is not running a Film Tension/Platter fault will stop the projector and close the zipper.

If a Show is running a Film Tension/Platter fault will sound the alarm, cause a message to appear on the screen and pause the Show. The system will run the Platter Fault Segment, this segment needs to be pre-programmed to tell the system what you want it to do in the event of a platter or tension fault. If the Platter Fault Segment has not been programmed, the system will revert to the default settings. Under all circumstances the projector motor will be switched off and the zipper closed, however the settings for the lens, curtains and masking will remain unchanged.

If the projector motor is on and a Platter or Film Tension Fault occurs during a Show, the screen will look like this:

SHOW # 1	Time: 18:54:23
***** SHOW CANNOT START OR CONTINUE *****	
PLATTER OR FILM TENSION FAULT	
OVERIDE	

When the fault is cleared the alarm will stop and the screen will display a "Show Paused by Fault" message. The show can then be re-started by pressing the START/RESUME button. The show will then pick up exactly where it left off before the fault occurred. Pressing the **OVERIDE** softkey will allow the Show to be started or to be re-started in spite of the existence of a fault condition.

You *can* start a show before the projector is laced up, but, if the fault is not cleared by the time the projector start command is issued by the automation, the alarm will sound and the show will be halted. The **OVERIDE** softkey can also be used to silence the alarm whilst the fault is being rectified.

FIRE ALARM

On receipt of a signal from the fire panel, the alarm will sound and the automation will run the Fire Fault segment (which must be pre-programmed). If the Fire fault segment has not been programmed the system will revert to the default settings. The curtains, masking and lens settings will remain unchanged. On removal of the fire signal, the show can be resumed.

When a Fire Alarm occurs, the screen will look like this:

SHOW # 1	Time: 18:54:23
***** SHOW CANNOT START OR CONTINUE *****	
*****FIRE ALARM*****	
OVERIDE	

Pressing the **OVERIDE** softkey will allow the program to be re-started in spite of the existence of a Fire Alarm condition. Pressing the **OVERIDE** softkey will silence the alarm whilst the Fire Alarm is being investigated. Should you be in programming mode and receive a fire signal, the 'FIRE FAULT' segment will be run and you will be taken out of programming mode and returned to the main screen.

XENON / EXCITER FAULT

If the xenon and/or the exciter are not illuminated when the zipper is about to open, the alarm will sound, a message will appear on the screen and the Show will be paused. The system will run the Xenon Fault Segment (which must be pre-programmed). If the Xenon Fault Segment is not programmed the system will revert to the default settings. The settings for the curtains, masking and the lens will remain unchanged.

When a Xenon Fault occurs, the screen will look like this:

SHOW # 1	Time: 18:54:23
***** SHOW CANNOT START OR CONTINUE *****	
XENON OR EXCITER NOT WORKING	
OVERIDE	

Pressing the **OVERIDE** softkey will allow the program to be re-started in spite of the existence of a fault condition. This is useful if the exciter lamp has failed but the Show can still be run in Digital. The **OVERIDE** softkey can also be used to silence the alarm whilst the fault is being rectified.

SETTING UP THE A-D LEVELS FOR XENON / EXCITER FAULTS

From the SYSTEM SETUP screen,
Pressing the VIEW LEVELS softkey will display the following screen:

ADC 3&4		CONVERTER LEVELS		
ADC1	ADC2	DAC1	DAC2	
000	000	128	128	EXIT

Pressing the **ADC 3&4** softkey will reveal the AD3 and AD4 levels in the positions previously occupied by the AD1 and AD2 levels. The screen can be toggled back and forth between the display of the ADC 1&2 and ADC 3&4 levels.

ADC1 shows the input level of Analogue to Digital Converter #1 on the AS101 card. This input is used for the Projector 1 Xenon fault input.

ADC2 shows the input level of Analogue to Digital Converter #2 on the AS101 card. This input is used for the Projector 2 Xenon fault input.

ADC3 shows the input level of Analogue to Digital Converter #3 on the AS101 card. This input is used for the Projector 1 Exciter fault input.

ADC4 shows the input level of Analogue to Digital Converter #4 on the AS101 card. This input is used for the Projector 2 Exciter fault input.

DAC1 shows the output level of Digital to Analogue Converter #1 on the AS101. This level is determined by the setting of the main volume control.

DAC2 shows the output level of Digital to Analogue Converter #2 on the AS101. This level is determined by the setting of the Monitor volume control.

FAULT DEFAULT SEGMENTS

The 3 fault Segments are multiple event segments that contain the desired status that different pieces of equipment should default to during that particular fault.

There is a FIRE Fault segment called FIRE-FLT, a XENON Fault segment called XEN-FLT and a PLATTER Fault segment call PLAT-FLT. These segments are programmed the same as any other segment, please refer to Automation Programming for complete instructions of how to program a segment.

If a fault occurs during a show and the segment for that particular fault has not been programmed, the automation will default to the standard default settings.

STORE DEFAULT SETTINGS TUTORIAL

We suggest the following tutorial as a guide.

Press the **PROJECTOR CONTROL** key and set the defaults as...

OFF	ON	OFF	ON	SLIDE
PROJ 1 MOTOR		- XENON 1 --		CONTROL
- PICTURE 1 --		-- LENS 1 --		
OFF	ON	WIDE	SCOPE	EXIT

If you are using 2 projectors, press the **PROJECTOR CONTROL** key again and set the defaults of the second projector as...

OFF	ON	OFF	ON	SLIDE
PROJ 2 MOTOR		- XENON 2 --		CONTROL
- PICTURE 2 --		-- LENS 2 --		
OFF	ON	WIDE	SCOPE	EXIT

Press the **SLIDE CONTROL** softkey and set the defaults as...

FWD	REV	IN	OUT	GOTO
-- SLIDE --		-- FOCUS --		SLIDE #
----- SLIDE MACHINE -----				
CYCLE	RESET	OFF	ON	EXIT

Press the **CURTAINS / MASKING** key and set the defaults as...

STOP	PLAY	RWD		AUXILIARY
-----	TAPE/DISK	-----		CONTROL
- CURTAINS -		- MASKING -		
CLOSE	OPEN	WIDE	SCOPE	EXIT

Press the **AUXILIARY CONTROL** softkey and set the defaults of the 8 auxiliary relays to suit your requirements. Press the **LIGHTS** key and set the defaults as...

UP	PRE 1	PRE 2	DOWN	
-----	HOUSE LIGHTS			-----
-----	CURTAIN LIGHTS			-----
UP	PRE 1	PRE 2	DOWN	EXIT

Press the **SOUND** key and set the defaults as...

STEREO	SR	MONO	DOLBY	DTS
			DIGITAL	DIGITAL
NON-	NON-			
SYNC 1	SYNC 2	MIC	MAG	EXIT

Press the **EXIT** softkey. Now press the **MENU** key then press the **STORE DEFAULT** softkey, the following screen will be displayed for two seconds.

Default Settings Stored!!!

Your default settings are now stored.

The **EXIT** softkey returns you to the main screen.

AUTOMATION OPERATION

RUNNING A SHOW

Shows can be started manually, by setting a timer or by using the Session Programming feature.

To Start A Show without the Timer

Press a **SHOW #** key to put the system in **SHOW READY** mode. The screen will look like this:

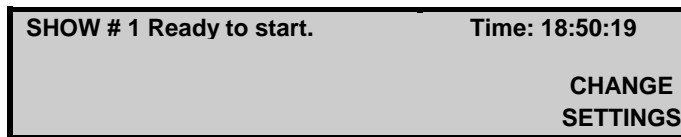

Press the **START/RESUME** key and the Show will start

To Start A Show Using the Timer

Press a **SHOW #** key to put the system in **SHOW READY** mode, but do not press the **START/RESUME** key. Press the **CHANGE SETTINGS** softkey. The screen will change to look like this:

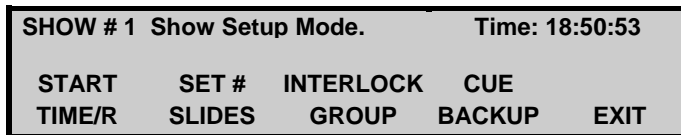

This screen allows you to set the start timer, change the number of slides in the slide show, setup the cinema interlock and enable the Cue Backup feature. The **START TIME/R** softkey displays the following screen:

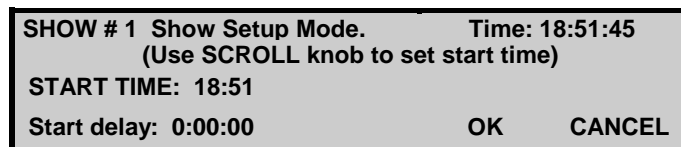

At the top right corner of the display the current time is displayed. The Volume control changes to a Scroll control as indicated by the volume display changing to two dashes [--]. Rotating the **SCROLL** control will change the start delay time in increments of one minute. The actual start time is calculated and displayed on the screen above the Start Delay.

When you have set the start time/delay, press the **OK** softkey to return to the Show Ready screen. This will also start the timer. The screen will return to the Show Ready screen:



The timer will count down to the start time and start the selected show.

Show Running screen

Once a show has commenced a screen similar to the following will be displayed.

A →	SHOW# 1 Now Running...	Time: 19:00:00	← C
B →	Segment: SLIDES 1 Event# 1	Elap: 0:01:00	← D
E →	Next Ev: LAST-SL PRJ1-ON XEN1-ON		
E →			

A - The show that is running and it's current status.

B - The segment and the event of the segment that program is up to.

C - The current time in hours, minutes and seconds. 24-hour clock.

D - The elapsed time of the show running in hours, minutes and seconds.

E - Both of the bottom rows display the next cue that the system is looking for (Last Slide Cue) and actions that will take place once this cue is received (projector 1 motor and xenon ON). These are shown using short form labels to save screen space.

PAUSING A SHOW

Pressing the **PAUSE SHOW** key will stop the show that is currently running and the system will revert to the Default Settings.

Pressing the **START/RESUME** key will restart the show where it left off. If the projector was running and there was a picture on the screen, the automation will first start the projector, light the xenon, dim the house lights and after three seconds, the automation will put the picture back on the screen and turn the film sound back on.

Note: **PAUSING A SHOW** will not cause curtain, masking or lens changes.

SKIPPING CUES IN A SHOW

The Panalogic automation will only react to a cue from the source that it is actually expecting for the given Event in a program. All other cue sources will be ignored. Should you realise that there is an extra cue on the film, or if you don't want the automation to advance to the next event on the next cue, you can press the **START/RESUME** key and the automation will ignore all cues. The display will flash ***IGNORE CUES*** and the automation will beep repeatedly to remind you that you have this feature enabled. Pressing the **START/RESUME** key again will return the automation to its normal running mode.

STEPPING THROUGH A SHOW BEFORE STARTING

It is possible to step through a show without actually starting it. This can be useful if you wish to bypass the first part of a show and start from some point within the show.

To do this press a **SHOW #** key to display the Show Ready screen. Now press the **NEXT EVENT** key to step into the show. Each press of the key will step to the next event. When you reach the point from which you wish to start (eg. after the slides) press the **START/RESUME** key and the show will start from that point.

You can step both forward and backward within the show using the **NEXT EVENT** and **PREVIOUS EVENT** keys.

CHANGING EVENTS IN A SHOW

While a show is running, it is possible to step to the next event or back to the previous event using the **NEXT EVENT** and **PREVIOUS EVENT** keys. This is useful if you have forgotten to place a foil cue on the film, if you wish to pre-empt a cue, or if a phantom cue has caused the program to jump too far forward.

PROGRAMMING SHOWS AND SEGMENTS WHILE A SHOW IS RUNNING

It is possible to program new Segments or Shows or make changes to existing Segments or Shows whilst a show is running. To do this, simply follow the instructions for programming in the next chapter.

The only restriction is that while you are in programming mode, execution of the current running show will be suspended. That is, no new cues will be accepted and therefore the show will not step forward, until you exit from programming mode.

Therefore if you wish to program whilst a show is running it is advisable to do so during the feature when cues are few and far between. You can also make changes to the program for current running show. Any changes that you make will take effect as soon as you exit programming mode.

CHANGING THE VOLUME SETTING DURING A SHOW (VOLUME UPDATE)

If you wish to change the volume whilst a show is running because the level in the auditorium is too loud or too soft, simply turn the volume control to the desired level. This new level can be stored in the current program at the point where the last volume or format change occurred so that the next time the show is run the projectionist will not have to alter the level again. When a show is running and a manual volume change is performed, the word **UPDATE>** appears at the bottom right of the screen...

SHOW# 1 Now Running...	Time: 19:10:16
Segment: TRAILER1 Event# 1	Elap: 0:11:16
Next Ev: CNTRCUE LEN1-SC MASK-SC PIC1-ON	
HSLT-DN STER/SR VOL-55	UPDATE>

Pressing the **UPDATE>** softkey will store a volume change for the new volume at the previous volume or format change. If the **UPDATE>** key is not pressed the existing program will not be altered. The **UPDATE>** softkey will disappear once the program receives the next expected cue and steps forward to the next event.

SETTING THE NUMBER OF SLIDES

The Number of Slides in the carousel that are to be included in a slide presentation can only be set after you enter Show Ready mode. The Number of Slides is "global" in that it applies to **ALL** Shows and will therefore continue to apply to all future sessions until it is changed.

To set the number of slides, press a **SHOW #** key to put the system in **SHOW READY** mode, but **do not** press the **START/RESUME** key. The display will look like this:

SHOW # 1 Ready to start.	Time: 20:00:00
CHANGE SETTINGS	

Press the **CHANGE SETTINGS** softkey. The screen will change to look like this:

SHOW # 1 Show Setup Mode.				Time: 20:01:24	
START	SET #	INTERLOCK	CUE		
TIME/R	SLIDES	GROUP	BACKUP	EXIT	

The **SET # SLIDES** softkey will display the following screen.

SHOW # 1 Show Setup Mode.				Time: 20:01:53	
(Use Scroll Knob to set # of slides)					
NUMBER OF SLIDES: 0				OK	CANCEL

Use the scroll knob to set the number of slides then press the **OK** softkey.

INTERLOCKING CINEMAS

Cinemas can be interlocked together so that one print can be shown on more than one screen at the same time. When cinemas are interlocked together the projector Stop and Start controls, Show Start and Show Pause functions are locked together. Two or more cinemas can be interlocked together by assigning each cinema to the same INTERLOCK GROUP. It is possible to set up 32 separate interlock groups.

To set up a cinema for interlock mode, enter Show Ready mode.

1. Press a **SHOW #** key to put the system in **SHOW READY** mode, but **do not** press the START/RESUME key. The display will look like this.

SHOW # 1 Ready to start.				Time: 11:00:19	
				CHANGE	
				SETTINGS	

2. Press the **CHANGE SETTINGS** softkey. The screen will change to look like this:

SHOW # 1 Show Setup Mode.				Time: 11:01:10	
START	SET #	INTERLOCK	CUE		
TIME/R	SLIDES	GROUP	BACKUP	EXIT	

The **INTERLOCK GROUP** softkey will display the following screen.

SHOW # 1 Show Setup Mode.				Time: 11:01:47	
Interlocked to group: 0					
				EXIT	

3. Use the **scroll knob** to set the group that you want to be interlocked with, then press the **EXIT** softkey. The following screen will be displayed when the cinema is interlocked to a group.

SHOW # 1 Ready to start.				Time: 11:02:05	
Interlocked to group: 3					
				CHANGE	
				SETTINGS	

If you don't want to interlock this cinema, set the interlock group to 0 and then press the **EXIT** softkey.

Pressing the **START/RESUME** key on any automation unit that is interlocked in a group will simultaneously start the Shows in all cinemas that are in Ready mode and are interlocked to the same group. Pressing either 'Projector Start' or 'Projector Stop' on any interlocked cinemas will start or stop all cinema projectors that are interlocked to the same group.

Any fault occurring in an interlocked cinema will cause the Shows in all interlocked cinemas in that same group to pause and display 'SHOW PAUSED BY USER', except for the cinema which caused the fault which will display 'SHOW PAUSED BY FAULT'.

See 'Programming for interlock' page 5.14

CUE BACKUP

The Cue Backup feature is a system that memorises the time it takes for each cue to be reached, this time can be used for later screenings of the same show. The system monitors the cues and if a cue is not received at the expected (learnt) time, due to a lost or damaged foil (or faulty sensor) the CA2000 will generate the appropriate cue causing the show to go to it's next event. The Cue Backup will then continue to monitor the next cue to make sure that it happens at the expected time.

Press the **SHOW #** key as if you are going to start a show, the Show number that you press will be the show that is to be used to Learnt from. Press the **CHANGE SETTINGS** softkey. The screen will change to look like this:

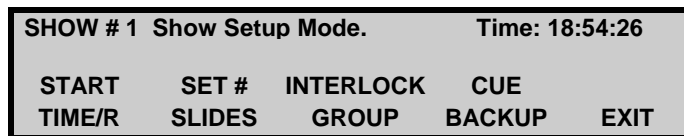

Press the **CUE BACKUP** softkey to enter the Cue Backup screen.

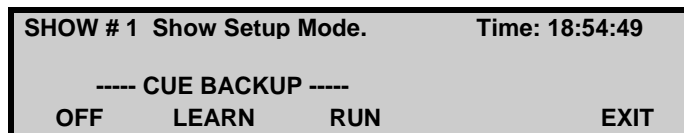

To learn a Show press the **LEARN** softkey, the following screen will be displayed:

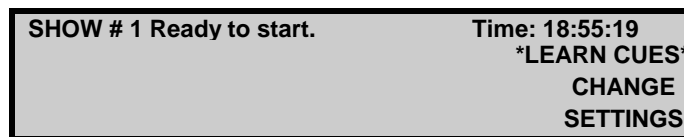

When the show is run the Cues will be stored in memory. The time that each cue occurs will be remembered, not the actions each cue causes as this is all in the Show Program memory. Once the show is learned, the cue backup must be turned on to enable the cues to be tracked. To do this enter the Cue Backup screen and set the Cue Backup to run by pressing the **RUN** softkey, the screen will now look like:

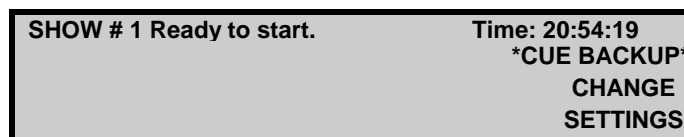

The next time the show is run it will be under the close scrutiny of the Cue Backup feature, so that if a cue is not seen by the appropriate sensor the 'Cue Backup' will generate the cue anyway.

There is a time window for cues of 1 second for the first ten minutes and then one-second for every ten minutes after that. This is to allow for the variation in projector speed or other anomalies that may occur. Therefore if we are at the end of a show (90minutes) and there is supposed to be a cue, the cue backup will wait for 9 seconds before doing the cue itself.

Each Show number has it's own Learn memory, the cue backup feature will track the appropriate show's cue memory. Care must be taken when using the Cue Backup feature so that films that have not been memorised are not shown under the Cue Backup mode.

It is possible to show films without the use of foil cues although this is not recommended. Program the show as required and enable the Learn Cues option. Run the film through once pressing the Next Event key where you wish to insert the cues, each of the cue's times will be remembered. Once the show has concluded, set the Cue Backup feature on. The next time the show is run, the cues will all happen as required.

AUTOMATION PROGRAMMING

Press the MENU key to access the Menu Screen. The screen will look like...

SET	OPTIONS	NETWORK	STORE	SYSTEM
CLOCK		COPY	DEFAULT	SETUP
----- PROGRAM -----				
SESSION	SHOW	SEGMENT		EXIT

The lower left section of the screen has three softkeys that allow access to the programming functions.

The **PROGRAM SESSION** softkey is for programming and viewing session times and shows for the cinema. A Session is a show that is set to start at a pre-programmed time.

The **PROGRAM SHOW** softkey is for programming and viewing the Segments in a Show. A Show consists of one or more pre-programmed segments.

The **PROGRAM SEGMENT** softkey is for programming and viewing the Events in each Segment. A Segment consists of one or more pre-programmed events.

There are two possible ways to set up a SHOW program.

The first and most simple method is to create a SHOW that contains just one SEGMENT of up to 16 events. When the SHOW is run, each EVENT in the Segment causes various pieces of equipment to be turned on or off or to change settings. This is just like a pin matrix system and like a pin matrix, there is no real limit to the number of things that can be turned on or off with each EVENT.

The second method is to create a SHOW that contains a sequence of several SEGMENTS. This allows easier editing of SHOWS at a later time, as a SHOW can be sub-divided into several sections (features, trailers, slides, start projector, closers, and faults), each of which can be individually edited. Each individual SEGMENT can also be used in several SHOWS.

PROGRAMMING A SEGMENT

A SEGMENT is a sequence of individual EVENTS. A Segment can contain up to 16 Events. Programming of a Segment involves programming each Event in order, starting at Event 1.

From the Menu Screen Press the Program **SEGMENT** softkey, this enters the Segment Program screen.

Programming Segment: FEATURE1		Event #
(Use SCROLL knob to select segment)		
COPY	OK	EXIT

When you enter this screen the two-digit volume display changes to two dashes. This indicates that the volume knob is now functioning as a SCROLL control. A message on the screen tells you to turn the SCROLL control to select a segment to program.

You will see that there are 32 segments called FEATURE1-15, TRAILER1-9, SLIDES1-2, START-PR, CLOSER1-2, PLAT-FLT, XEN-FLT and FIRE-FLT. These segments each have different names for

convenience, they each have the same programming capacity which is 16 events each. The 3 fault segments should not be used in programming shows. Select the Segment that you wish to program and press the **OK** softkey. If the segment you chose has already been programmed, you will see the programmed Event #1 displayed on the screen, we will presume that your chosen segment is not programmed.

Programming Segment: FEATURE1				Event # 1
THIS EVENT NOT PROGRAMMED				
TRIGGER	INSERT	DELETE	STORE	EXIT

Each Event contains a TRIGGER setting, which determines what will cause the event to happen. There are six Triggers to chose from:

- MANUAL** the operator must manually press the NEXT EVENT key to execute the Event.
- CNTRCUE** Centre foil film cue.
- OUTCUE** Outboard foil film cue.
- INCUE** Inboard foil film cue.
- WAIT- xx** Wait xx seconds before executing the Event. The wait time (xx) can be between 0 and 99 seconds. Events with a Wait-xx Trigger can be cascaded so that several Events will occur in succession, each one a given time later than the one before.
- LAST-SL** LAST SLIDE cue. The Event is activated by the last slide in the carousel. It can be used to start the projector, or perform some other action, when the last slide is reached.
- SLIDExx** On slide # cue. The Event is activated when slide number xx is in the gate of the slide projector. This trigger uses the slide counter which increments with each slide pulse.

These triggers are selected by pressing the TRIGGERS softkey until the one you want is displayed. The default trigger is MANUAL.

Once you have selected a trigger, you must set the status for the equipment in that event. In the following example, a MANUAL trigger was used to turn Projector 1 ON, Xenon 1 ON, OPEN the Curtains, set the house lights dimmer to PRESET 1, set the curtain lights dimmer to DOWN, select STEREO and change the volume to 65. The screen will look like...

Programming Segment: FEATURE14				Event #1
MANUAL	PRJ1-ON	XEN1-ON	CURT-OP	HSLT-P1
CNLT-DN	STEREO	VOL-65		
TRIGGER	INSERT	DELETE	STORE	EXIT

Once you are satisfied with the event you **MUST** press the **STORE** softkey to save it. If you do not, the event will not be saved.

If a second event is required, press the **NEXT EVENT** key to increment to Event #2. Program the event, starting with a Trigger and then the equipment status as per Event #1.

If more detail on Segment programming is required, refer to the 'Segment Programming Tutorial' towards the end of this chapter.

The Display System

Each Event stores the state of the switches for all of the attached equipment. However rather than show the state of every switch, the system is designed so that only the switches that are to change will be displayed. This simplifies the display making it easier to read. During programming, the switches that will change for each event are displayed as each Event is displayed (see screen above). It is possible that there could be more changes than there is space on the display, in this case the two lines will alternate every two seconds.

EDITING A SEGMENT

Once a Segment has been programmed, it is possible to go back later and insert or delete Events as well as edit existing events.

To delete an Event from a Segment

Enter the PROGRAM SEGMENT screen and select the Segment that you wish to edit by using the scroll control as you would if you were going to program it, press the **OK** softkey. The screen should look something like this:

Programming Segment: FEATURE14				Event #1
MANUAL	PROJ1-ON	XEN1-ON	CURT-OP	HSLT-P1
CNLT-DN	STEREO	VOL-65		
TRIGGER	INSERT	DELETE	STORE	EXIT

Use the **PREVIOUS EVENT** and **NEXT EVENT** keys until you find the number of the Event that you want to delete. Now press the **DELETE** softkey. All of the Events that were higher in number will now be shifted down by one. For example if you deleted Event number 1, Event 2 will become Event 1, Event 3 will become Event 2 and so on.

To 'Insert' a new Event into a Segment:

Enter the PROGRAM SEGMENT screen and select the Segment that you wish to edit by using the scroll control as you would if you were going to program it, press the **OK** softkey. The screen should look something like this:

Programming Segment: FEATUR14				Event # 1
MANUAL	PROJ1-ON	XEN1-ON	CURT-OP	SLID-OF
HSLT-DN	STEREO			
TRIGGER	INSERT	DELETE	STORE	EXIT

USE THE PREVIOUS EVENT and **NEXT EVENT** keys until you find the Event number **before** the location of your soon to be inserted Event. For example, if your Segment contains 10 Events and you want to insert a new Event between Events 6 and 7 select Event # 7 and then press the **INSERT** softkey. A new Event #7 will be created and the display will look like this:

Programming Segment: FEATUR14				Event # 7
THIS EVENT NOT PROGRAMMED				
TRIGGER	INSERT	DELETE	STORE	EXIT

Now select the TRIGGER and the switches that you want to change for this event in the same way that you would if you were programming an Event. Then press the **STORE** and then the **EXIT** softkeys. The Event that was previously Event 7 has been moved to Event 8, Event 8 has been moved to Event 9 and so on.

Editing a Programmed Segment

It is possible to edit a segment that is already programmed, you may need to add a lens change, delete a lighting change, change the triggers source etc.

Editing a segment is done exactly the same way as programming, ie. Entering the program segment mode and then select the desired segment. Once the Segment is selected step through the events by pressing the **PREVIOUS EVENT** and **NEXT EVENT** keys until you get to the event that you wish to edit, now simply change whatever needs to be changed. Once you are satisfied with the event press the **STORE** softkey to save the changes. If the store softkey is not pressed the changes you made will not be saved.

PROGRAMMING VOLUME CHANGES AND MUTE COMMANDS IN SEGMENTS

If it is desired to have a volume change during an Event, just turn the volume control and an entry will appear that shows the volume as you change it. When you get the volume level that you want, press STORE and a "volume change" will be stored for the Event.

A volume change is displayed as **VOL-xx**, where xx is the volume level that will be used after the change. You can modify the volume level at any time whilst you are programming an Event by rotating the volume control and pressing STORE.

If you wish to remove a volume change entry, turn the volume control to "99" and the volume entry will disappear. Press to be STORE key to save the change. You can also store a volume MUTE command by pressing the **MUTE** key below the volume knob. The volume numeric display will flash indicating that MUTE is activated.

When programming a segment, Change the Volume control to 65, the screen will look something like this, depending on the other changes you have programmed during the event:

Programming	FEATUR14	Event # 1
MANUAL PRJ1-ON	XEN1-ON	CURT-OP
CNLT-DN	VOL-65	HSLT-P1
TRIGGER	INSERT	DELETE
		STORE
		EXIT

The volume level will change to "65" when this Event occurs in a running show.

Press the **MUTE** key (it is located below the volume control), the screen will now look like:

Programming	FEATUR14	Event # 1
MANUAL PRJ1-ON	XEN1-ON	CURT-OP
CNLT-DN	VOL-65	MUTE
TRIGGER	INSERT	DELETE
		STORE
		EXIT

When you are satisfied with the event press the **STORE** softkey. The MUTE is turned off automatically whenever you change sound formats.

PROGRAMMING SEGMENTS FOR SLIDE CONTROL

There are four main ways to control slides.

1. Use the automation to turn on the slide projector. Advance each slide by using "WAIT" commands in the automation to "FWD" the slide projector. The automation "FWD" relay is connected to the slide advance input.

Programming method: A separate Event is used for each slide. Each Event consists of a **WAIT** command and a slide **FWD** command.

2. Use the automation to turn on the slide projector. Advance each slide using the built in timer in the slide projector or a separate timer connected to the "advance slide" input. Use a sensor on the slide machine carousel to detect the last slide for the automation to start the next event. The sensor is connected to the Last Slide input relay of the automation.

Programming method: Only one Event is used with a Last Slide trigger to start the next Event (usually the film projector). The Number of Slides must be set to "0". The automation will not forward the slide machine when set to "0". Should you wish to advance the slide on sensing the 'Last Slide', then set the number of slides to "1".

3. Use the automation to turn on the slide projector. Advance slides using a pre-recorded pulse from an audio source such as a tape deck or a Mini Disc player, which is connected directly to the slide machine's "advance slide" input. Use a sensor on the slide machine carousel to detect the last slide for the automation to start the next event. The sensor is connected to the CA2000's Last Slide input relay.

Programming Method: Only one Event is used with a Last Slide trigger to start the next Event (usually the film projector). The Number of Slides must be set to "0". The automation will not forward the slide machine when set to "0". Should you wish to advance the slide on sensing the 'Last Slide', then set the number of slides to "1".

4. Use the automation to turn on the slide projector. Advance slides using a pre-recorded pulse from an audio source such as a tape deck or a Mini Disc player, which is, connected to the Last Slide input relay of the automation system. The automation advances the slide machine on each pulse and counts the number of pulses to determine when the last slide is in the gate and then the automation starts the next event.

Programming Method: Only one Event is used with a Last Slide trigger to start the next Event (usually the film projector). The Number of Slides must be set to the correct number of slides in the carousel. The automation counts each pulse and when the number of slides counted matches the Number of Slides setting the next Event is triggered. Once the Number of Slides value is set it remains the same until it is changed.

PROGRAMMING SEGMENTS for INTERLOCKING

There are several things to keep in mind when programming for interlocked shows.

- The first cinema to reach a 'Start Projector' command in its program will start the projectors in all interlocked cinemas. It may be necessary to progressively delay the start of the Show in each cinema along the interlocked film chain. Because the Shows in ALL interlocked cinemas will start simultaneously, delaying the start of each cinema's normal program can easily be achieved by inserting a WAIT command as the second Event in each cinema's Show program. To do this, make the first Event a MANUAL trigger with no other commands. Then for the second Event use a WAIT command as the trigger along with the other commands that you would normally have in the first Event. When the Show is started, the automation will wait for the programmed number of seconds before executing the other commands.
- If you are running a slide show prior to the film presentation you need to ensure that each slide show will finish before the first film cue passes through each projector, otherwise the film cues will not be seen. (The automation will still be looking for a last slide cue and not a film's cue if the slide show hasn't finished). The slide shows can be timed to finish just before the film foil passes through the projectors by using WAIT commands to delay the start of the slide shows.

- You need to make sure that only the last cinema in the film chain has a 'Projector Stop' command at the end of its program. This is to ensure that the film is not stopped until the last cinema reaches the end of the feature. For this purpose, you can program the CLOSER 2 Segment without a 'Projector Stop' command for use in the interlock programs for all but the last cinema.
- If you have film break detectors fitted to each projector, there needs to be enough leader on the end of the film so that the last film cue can go past every projector before the film runs out of the first projector and stops it... (Because, if one stops, they all stop!)
- Any fault on any interlocked cinema in a group will stop all the interlocked cinemas in the same group.
- The show can be started, paused or stopped at any console that is interlocked within the same group.
- The use of some form of film accumulator is recommended between each projector.
- All the projectors must run at the same speed.

PROGRAMMING A SHOW

A Show consists of one Segment or a series of Segments that carry on one after one another, ie. SLIDES 1, TRAILER1, FEATURE1 then CLOSER 1.

From the Menu Screen, Press the Program **SHOW** softkey. This enters the Show Program screen.

Programming SHOW#	Segment#
(Press a SHOW button to select a Show)	
COPY	OK EXIT

Follow the on screen instruction, use the Show buttons to select the Show number that you wish to program. If you press the wrong show button, simply press the correct one then press the **OK** softkey. If the Show you have chosen is already programmed you will see a Segment Name such as SLIDES 1 on the screen, we will assume that the Show is not programmed.

Programming SHOW# 1	Segment# 1
Segment Name: SEGMENT NOT PROGRAMMED	
COPY	OK EXIT

The volume display will have changed to dashes to indicate that the SCROLL can be used to select a Segment as the first Segment in the Show. Rotate the scroll control until the desired segment (eg. FEATURE1) is displayed next to "Segment Name: ", then press the **STORE** softkey.

Programming SHOW# 1	Segment# 1
Segment Name: FEATURE1	
CHECK	INSERT DELETE OK EXIT

Note: The words NOT PROGRAMMED will remain on the screen until the STORE button is pressed.

If more than one segment is to be programmed into the show, press the **Segment#** Softkey to increment the Segment number and then use the scroll control to select the next Segment, press store and so on.

If more detail on Show programming is required please refer to the Show programming Tutorial towards the end of this chapter.

CHECKING THE CONTENTS OF A PROGRAMMED SHOW

It is possible to check the contents of a Show using the Check feature, which is accessible through the Show programming screen. From the Show programming screen press the **CHECK** softkey.

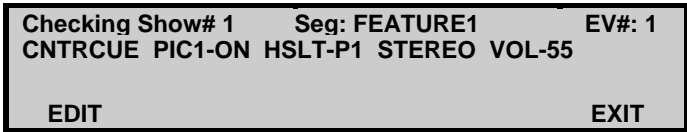

This screen displays the Show #, Segment name, Event number and all changes that occur in the event including the cue type. The show can be stepped through using the 'Next Event' and 'Previous Event' keys.

Note: Although the show is being stepped through the changes will not actually take place.

The **EDIT** softkey will take you to the Segment programming screen to edit the event in the segment that the check screen was in when the edit softkey was pressed. In the example above this would be Event 1 in FEATURE1. **Note:** Editing a segment will effect all the shows that use the segment that was edited.

EDITING A SHOW

Once a Show has been programmed it is possible to go back later and insert or delete Segments, or make changes to existing ones.

To delete a Segment from a Show

Enter the PROGRAM SHOW screen and select the SHOW that you wish to edit by pressing the appropriate SHOW key, press the **OK** softkey. The screen should look something like this:

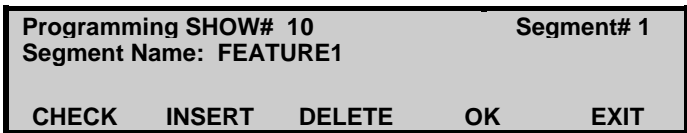

Press the **SEGMENT#** softkey until you find the segment that you want to delete. Now press the **DELETE** softkey. All of the Segments that were higher in number, will now be shifted down by one. For example if you deleted Segment number 1, Segment 2 will become Segment 1, Segment 3 will become Segment 2 and so on.

To Insert a Segment into a Show

Enter the PROGRAM SHOW screen and select the SHOW that you wish to edit by pressing the appropriate SHOW key, press the **OK** softkey. The screen should look something like this:

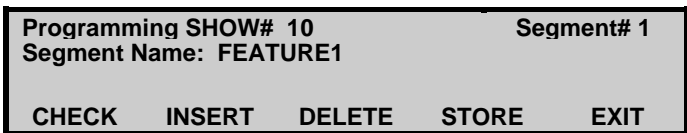

Press the **Segment#** softkey until you find the Segment number **before** the location of your soon to be inserted Segment. For example, if your Show contains 10 Segments and you want to insert a new Segment between Segment 3 and 4 press the **Segment#** softkey until you are displaying Segment# 4. Now press the **INSERT** softkey. A new Segment #4 will be created and the display will look like this:

Programming SHOW# 10	Segment# 4			
Segment Name: SEGMENT NOT PROGRAMMED				
CHECK	INSERT	DELETE	STORE	EXIT

Now, select the Segment you want to insert into the show, press the **STORE** and then the **EXIT** softkeys if you have no more editing to do. The Segment that was previously Segment 4 has been moved to Segment 5, Segment 5 has been moved to Segment 6 and so on.

Editing Segments in a Show

It is possible to edit a Show that is already programmed. This may be necessary if you wish to run a Scope feature instead of a Wide screen feature. All you need to do is change from your programmed Wide segment to a programmed Scope segment.

Editing a show is done exactly the same way as programming, ie. By entering the 'program show' mode and selecting the desired show. Once the Show is selected, step through the segments using the Previous and Next Event keys until you get to the segment that you wish to change. Now simply change to the desired segment using the scroll control and press the **STORE** softkey to save the changes to every segment that you change, if the store softkey is not pressed the changes you made will not be saved.

PROGRAMMING SESSIONS

The CA2000 provides the facility to program up to 16 start times with associated show numbers for up to 21 days in advance. Access to session programming is via the main menu. Press the **PROGRAM SESSION** softkey to enter the session programming screen.

Programming Sessions for: 2/8/99 (Use SCROLL knob to select date)		
COPY	OK	EXIT

Turning the volume / scroll knob will change the date. Programmable dates are the current date and up to 21 days in advance. Select the date you wish to program and press the **OK** softkey. The following screen will be displayed if the session has not been programmed...

Programming Sessions for: 2/8/99 Session: 01 SESSION NOT PROGRAMMED				
TIME	INSERT	DELETE	STORE	EXIT

Turning the volume / scroll knob changes the session that you are to program. Select a session and then press the **TIME** softkey.

Programming Sessions for: 2/8/99 Session: 01 08:00 SHOW# 01				
TIME	INSERT	DELETE	STORE	EXIT

Turning the volume / scroll knob will change the time that you want that session to start. Now select the show number that you want to run by pressing a Show key.

Press the **STORE** softkey. You have now programmed a Show # to start at a certain time on a certain day. Another session can now be programmed onto the same day by repeating the above process or to program a different day press the **EXIT** softkey and reselect the date.

Up to sixteen Sessions can be programmed one after the other on any given day.

Note: If one session is due to start and another session is still running, the show will not start at all. Therefore care must be taken when programming session times so that overlaps do not occur.

EDITING PROGRAMMED SESSIONS

Once a day's Sessions have been programmed it is possible to go back later, insert extra sessions, delete unwanted sessions or edit existing ones.

To delete a Session from a Date

Enter the PROGRAM SESSION screen and select the Date that you wish to edit using the Scroll control and press the **OK** softkey. The screen should look something like this:

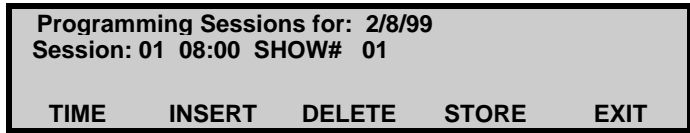

Scroll through the Session using the scroll control until you find the session that you want to delete. Now press the **DELETE** softkey. All of the Sessions that were higher in number will now be shifted down by one. For example if you deleted Session number 1, Session 2 will become Session 1, Session 3 will become Session 2 and so on.

To Insert a Session into a Programmed Date

Enter the PROGRAM SESSION screen and select the Date that you wish to edit using the Scroll control and press the **OK** softkey. The screen should look something like this:

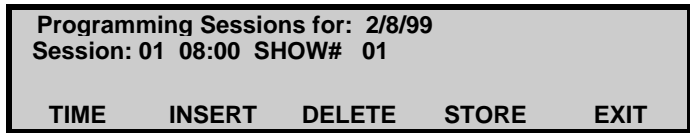

Scroll through the Session using the scroll control until you find the session number **before** the location of your soon to be inserted Session. For example, if your Day's programming contains 10 Sessions and you want to insert a new Session between Session 5 and 6, scroll through to Session# 6.

Now press the **INSERT** softkey. A new Segment #6 will be created and the display will look like this:

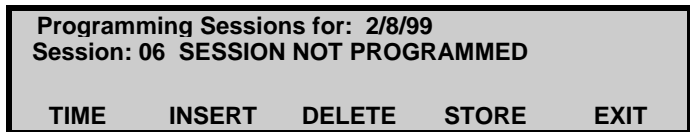

Press the **TIME** softkey and use the scroll control to change the time that you want that session to start, then select the show number that you want to run by pressing a Show key. Then press the **STORE** softkey and then the **EXIT** softkeys if you have no more editing to do.

The Session that was previously Session 6 has been moved to Session 7, Session 7 has been moved to Session 8 and so on.

Editing Programmed Sessions

It is possible to edit a Session that is already programmed. It may be necessary to change the start time or Show number of a particular show on a particular day.

Editing a Session is done exactly the same way as programming.

By entering the 'Program Session' mode and selecting the desired day. Once the Day is selected, step through the sessions using the Scroll control until you get to the session that you wish to change, the show number can be changed by simply pressing the desired show # key. If the time needs to be changed it is necessary to press the time softkey and then use the scroll control to change the time.

It is necessary to press the **STORE** softkey to save any changes that are made, if the store softkey is not pressed the changes you made will not be saved.

COPY AND PASTE PROGRAMMING

To make programming of the CA2000 faster, a copy and paste feature is available for all three programming modes (Segment, Show and Session).

CAUTION: Care must be taken when Pasting copied information so that Segments, Shows or Sessions that have already been programmed are not accidentally programmed over. There is no undo paste command.

Segment Copy and Past Programming

For example: Copy the contents of FEATURE1 and store (paste) it into any other segment and edit as required.

When you first enter Segment Program mode, the following screen is displayed.

Programming Segment: FEATURE1		Event #
(Use SCROLL knob to select segment)		
COPY	OK	EXIT

Select the Segment that you wish to copy using the Scroll control and then press the **COPY** softkey. An extra softkey function called "PASTE" will appear. Using the scroll control, select the segment that you wish to paste the information into and press the **PASTE** softkey. This can be repeated to as many segments as is necessary.

The copied segments can now be modified if required.

Show Copy and Past Programming

For example: Copy the contents of Show 1 and store (paste) it into any other show # and edit as required.

When you first enter Show Program mode the following screen is displayed.

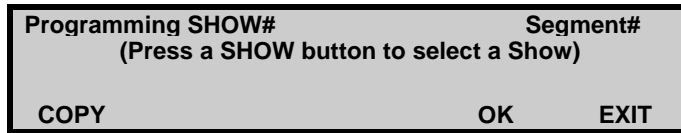

Select the Show that you wish to copy using the Show # keys and then press the **COPY** softkey. An extra softkey function called "PASTE" will appear. Select the Show # that you wish to paste the information into using the Show # keys and press the **PASTE** softkey, this can be repeated to as many Shows as necessary.

The copied shows can be modified if required.

Session Copy and Past Programming

For example: Copy the Session from the 1st day of the month and store (paste) it into any day of the month and edit as required.

When you first enter Session Program mode the following screen is displayed.

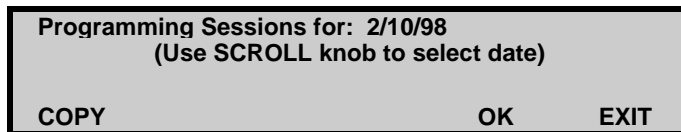

Select the Date that you wish to copy using the Scroll control and then press the **COPY** softkey. An extra softkey function called "PASTE" will appear. Using the scroll control, select the date that you wish to paste the information into and press the **PASTE** softkey, this can be repeated to as many dates as necessary.

The copied sessions can be modified if required.

NETWORK COPY

The CA2000 automation system has the ability to send the contents of its segments, shows and session times to other CA2000 systems (UPLOADING). The CA2000 can also receive the contents of segments, shows and session times from another CA2000 or a host computer (DOWNLOADING).

To perform memory functions it is necessary to enter the SYSTEM MENU. Pressing the MENU control key accesses this. The following screen will be displayed...

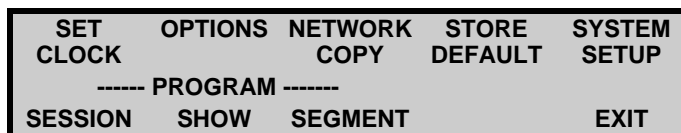

Press the **NETWORK COPY** softkey and the following screen is displayed...

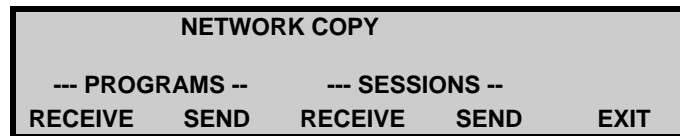

The **PROGRAMS** send and receive functions, transfer all program Memory, ie. Segments including all events in every Segment and in every Show.

The **SESSIONS** send and receive functions, transfer session information, ie. Show numbers and their start times for an entire month.

If the Source system is not programmed, then the transfer will still take place and you will transfer empty Sessions and Programs.

Sending Programs and Sessions to another Cinema

To Send programs to another cinema, press the **PROGRAMS SEND** softkey. To Send Sessions, the same process is followed after pressing the **SESSIONS SEND** softkey. The following screen will be displayed.

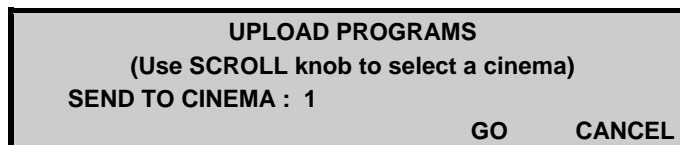

Turning the volume / scroll knob will change the cinema number. Setting the cinema number to 'ALL' will upload the programs to all the cinemas at the same time. Pressing the **GO** softkey will start the transfer. The display will change to the following screen.

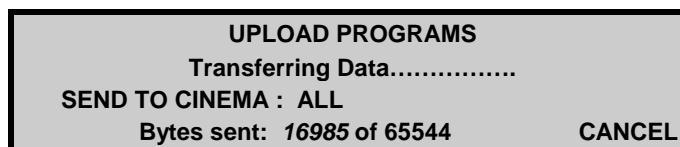

There is a running 'bytes sent' counter that provides an indication of how much data has been sent and how much remains to be sent. It takes about 90 seconds to transfer program data and about 45 seconds to transfer session data. If the operation needs to be aborted, simply press the **CANCEL** button and the system will abort the transfer and return to the Network Copy screen.

When complete the following screen will be displayed...

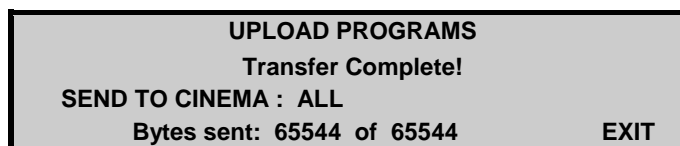

Pressing the **EXIT** softkey will return you to the 'memory functions' menu screen.

Note: UPLOADING programs and sessions will send a copy of the your CA2000's 10 Shows and 32 Segments and all it's session times, including any segments that are not programmed to the chosen CA2000.

Receiving Programs and Sessions from another Cinema

To **DOWNLOAD** (copy from) programs or sessions from another linked CA2000, press the appropriate **RECEIVE** softkey and follow a similar procedure to **UPLOAD** programs.

The unit will send out a request signal to the desired source cinema and the screen will display “waiting for data” on the display, once data is being received the screen will display “Transferring Data...”

Note: DOWNLOADING programs and sessions will give you a copy of the chosen CA2000’s 10 Shows and 32 Segments and all it’s session times, including any segments that are not programmed.

SEGMENT PROGRAMMING TUTORIAL

This tutorial will lead you through all the steps to program a simple show that will turn the lights down, open the curtains, start the projector, light the lamp, put a picture on the screen and change the sound. At the end of the show the lights will come back up, the projector will shut down, the curtain will close and the intermission music will come back on.

Before starting to program make sure that the Default Settings have been stored so that all of the equipment is in the state that it will normally be in before the show starts. Refer to *DEFAULTS STORED* tutorial.

Step 1 – Enter Programming Segment Mode

The first step in the programming process is to program one or more Segments. From the MAIN SCREEN, press the **MENU** button. The display looks like this:

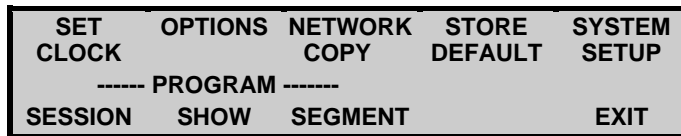

Now press the **PROGRAM SEGMENT** softkey to enter the Segment programming screen. The display now looks like this:

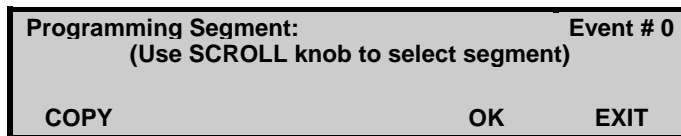

Turn the Volume/Scroll knob in either direction and you will see the names of the various segments displayed to the right of the words “Programming Segment:”

Step 2 – Select Segment

Select the Segment called FEATURE14 then press the **OK** softkey. If the segment *has not* been previously programmed the screen will look like this: Go to **STEP 3**.

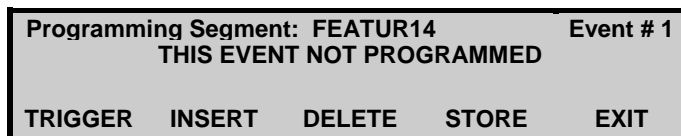

If the segment *has* been previously programmed the screen will look something like this:

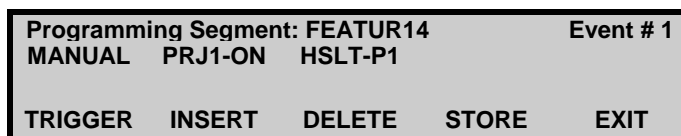

Check to make sure that *you do not need this segment* for your current cinema operation, (ask another projectionist, if it is a new installation you need not worry) as we will delete it.

Press the **DELETE** softkey until the screen looks like this:

Programming Segment: FEATUR14				Event # 1
THIS EVENT NOT PROGRAMMED				
TRIGGER	INSERT	DELETE	STORE	EXIT

Step 3. Selecting A Trigger

If a Segment is the first, or only Segment in a SHOW, the Trigger in EVENT 1 of the Segment is ignored. This is because the only way to start the Segment is by manually pressing the START/RESUME key or by setting the Show Start timer. We are going to set the Trigger to MANUAL anyway.

Press the **TRIGGER** softkey to select a trigger for Event 1. Each time the trigger softkey is pressed a new trigger will be displayed. Step through the TRIGGERS and select "MANUAL". Press the **STORE** softkey to save the Trigger setting. The screen now looks like this:

Programming Segment: FEATUR14				Event # 1
MANUAL				
TRIGGER	INSERT	DELETE	STORE	EXIT

Step 4. Select The Equipment To Turn On Or Off For This Event.

To select what equipment is to be controlled by the first Event simply press the appropriate Control key such as the PROJECTOR CONTROL key. The screen will change to the relevant equipment control screen and you can then set the equipment to the state that it should be in after the first Event occurs. The system uses abbreviated names (shortform labels) to indicate things that will change when an Event occurs.

Press the **PROJECTOR CONTROL** key. The following screen will be displayed.

OFF	ON	OFF	ON	SLIDE
PROJ 1 MOTOR		- XENON 1 --		CONTROL
- PICTURE 1 --		-- LENS 1 --		
OFF	ON	WIDE	SCOPE	EXIT

If you have done the *DEFAULT tutorial*, the displays will be flashing as shown. If the display looks different you should exit programming and do it now! Press the PROJ 1 MOTOR ON softkey to turn "ON" the projector 1 motor (it won't start the projector when you press it because we are in programming mode).

The screen will now have the following displays flashing.

OFF	ON	OFF	ON	SLIDE
PROJ 1 MOTOR		- XENON 1 --		CONTROL
- PICTURE 1 --		-- LENS 1 --		
OFF	ON	WIDE	SCOPE	EXIT

Now press the XENON 1 **ON** softkey, the screen will now have the following displays flashing.

OFF	ON	OFF	ON	SLIDE
PROJ 1	MOTOR	- XENON 1	--	CONTROL
- PICTURE 1	--	-- LENS 1	--	
OFF	ON	WIDE	SCOPE	EXIT

Press the **EXIT** softkey, the display will look like this:

Programming Segment: FEATUR14				Event # 1
MANUAL	PRJ1-ON	XEN1-ON		
TRIGGER	INSERT	DELETE	STORE	EXIT

Each new setting is added to the right of the previous one until the line is full, then the entries continue onto the next line down.

Press the **CURTAIN / MASKING** key and set the curtains to OPEN, the screen should look like...

STOP	PLAY	RWD	AUXILIARY	
-----	TAPE/DISK	-----	CONTROL	
- CURTAINS -		- MASKING -		
CLOSE	OPEN	WIDE	SCOPE	EXIT

Press the **EXIT** softkey, the screen should look like...

Programming Segment: FEATUR14				Event # 1
MANUAL	PRJ1-ON	XEN1-ON	CURT-OP	
TRIGGER	INSERT	DELETE	STORE	EXIT

Now press the **LIGHTS** key and set the HOUSE LIGHTS to PRE1 and the CURTAIN LIGHTS to DOWN, the screen should look like...

UP	PRE 1	PRE 2	DOWN	
-----	HOUSE LIGHTS	-----		
-----	CURTAIN LIGHTS	-----		
UP	PRE 1	PRE 2	DOWN	EXIT

Press the **EXIT** softkey, the screen should look like...

Programming Segment: FEATUR14				Event # 1
MANUAL	PRJ1-ON	XEN1-ON	CURT-OP	HSLT-P1
CNLT-DN				
TRIGGER	INSERT	DELETE	STORE	EXIT

If you make an error, you can go back to the Control screen and change the equipment back to the state what it was in before you changed it. The entry will then be removed from the list on the "Programming Segment" screen. When you are satisfied with the first event press the **STORE** softkey.

We can write down all of the above steps in a logical order.

SEGMENT: FEATUR14
EVENT#: 1

TRIGGER MANUAL this will be the first event in the Show
PROJECTOR ON turn the projector motor on

XENON	ON	turn the xenon lamp on
CURTAIN	OPEN	opens the curtains
HOUSE LIGHTS	PRESET 1	take the house lights to preset 1
CURTAIN LIGHTS	DOWN	take the curtain lights down

Always remember to press the STORE softkey before proceeding to the next Event or the changes you have made will not be saved.

Step 5. Program the Next Event

Proceed to Event 2 by pressing the **NEXT EVENT** key. Each time this key is pressed the Event number will increment by one. If Event 2 has not been previously programmed the screen will look like this:

Programming Segment: FEATUR14				Event # 2
THIS EVENT NOT PROGRAMMED				
TRIGGER	INSERT	DELETE	STORE	EXIT

You can now program this Event the same way as you did Event 1. Program the following settings.

SEGMENT: FEATURE14
EVENT#: 2

TRIGGER	WAIT-7	wait 7 seconds before doing this event
PICTURE	ON	put the picture on the screen
SOUND	STEREO	change the sound source to stereo
VOLUME	65	set the volume to 65.

Step through the TRIGGERS and select "WAIT". When the Wait trigger is displayed, the volume display changes to dashes to indicate that the SCROLL can be used to set the delay (or Wait) time.

Turn the **SCROLL** control until a delay of 7 seconds is indicated. Press the **STORE** key to save the Trigger and wait time setting. The SCROLL reverts back to a volume control when the STORE softkey is pressed.

Now go to the Projector Control screen and set the Picture to **ON**, then go to the Sound screen and set the sound to **STEREO**. You can go straight from the Projector Control screen to the Sound screen without pressing EXIT first. Now press the **EXIT** button in the Sound Screen.

Set the Volume to 65 and press store to save the setting. The Event #2 screen should look like this if you have got it right...

Programming Segment: FEATUR14				Event # 2
Wait-7	PIC1-ON	STEREO	VOL-65	
TRIGGER	INSERT	DELETE	STORE	EXIT

Press **STORE** to save the settings for Event #2.

Now go on to Event #3 by pressing the **NEXT EVENT** key. Program the following settings:

SEGMENT: FEATURE14
EVENT #: 3

TRIGGER	WAIT-10	wait 10 seconds before doing this event
PICTURE	OFF	take the picture off the screen
SOUND	NON SYNC 1	change the sound to non sync 1
HOUSE LIGHTS	UP	bring the house lights back up

The screen for Event #3 should look like this.

Programming Segment: FEATUR14				Event # 3
Wait-10	PIC1-OF	NSYNC1	HSLT-UP	
TRIGGER	INSERT	DELETE	STORE	EXIT

Proceed to Event #4 and program the following changes:

Event 4

TRIGGER	WAIT 10	wait 10 seconds before doing this event
CURTAINS	CLOSE	close the curtains
PROJECTOR	OFF	turn the projector motor off
XENON	OFF	turn the xenon off
LIGHTS	CURTAIN LIGHTS UP	raise the curtain lights

The screen for Event #4 should look like this...

Programming Segment: FEATUR14				Event # 4
Wait-10	PRJ1-OF	XEN1_OF	CNLT-UP	CURT-CL
TRIGGER	INSERT	DELETE	STORE	EXIT

Make sure you have pressed the STORE softkeys.

Now press the **EXIT** softkey.

You have now completed the segment programming for our short show.

You can view the programmed segment by going back to the start of this tutorial and step through each Event in the Segment we programmed. You can change the EVENTS if you have made a mistake, **remember to press the STORE softkey after you make any changes** otherwise your changes will not be remembered.

NOTE: Whilst you are programming a Segment, or checking a Segment, you can step both backwards and forwards between Events using the **NEXT EVENT** and **PREVIOUS EVENT** keys.

Before we can run the above program we need to program the segment into a SHOW. (see *SHOW PROGRAMMING*)

PROGRAMMING A SHOW TUTORIAL

We will now go through the steps needed to put the Segment that we programmed into a SHOW so that we can run it.

1. Enter Show Programming Mode

Press the **PROGRAM SHOW** softkey in the Menu screen. The screen will look like this:

Programming SHOW# 1	Segment#
(Press a SHOW button to select a Show)	
COPY	OK EXIT

2. Select the Show Number

Now press one of the 10 SHOW keys in the left area of the control panel to select the Show that you are going to program, (or press the **EXIT** softkey to return to the Menu screen).

If the Show that you select has not been previously programmed, the screen will now look like this:

Programming SHOW# 1	Segment# 1
Segment Name: SEGMENT NOT PROGRAMMED	
CHECK	INSERT DELETE STORE EXIT

3. Sequentially enter the Segments

For our Tutorial we will select FEATUR14, which we programmed in the *segment tutorial*. Press the **STORE** softkey to save this Segment as the first Segment.

As you selected "FEATUR14" as the first segment and press **STORE**, the screen will now look like this:

Programming SHOW# 1	Segment# 1
Segment Name: FEATUR14	
CHECK	INSERT DELETE STORE EXIT

If you only want to use one Segment for this Show you can now press the **EXIT** softkey. If you want to add additional Segments press the softkey above the Segment # 1 label to select the next Segment. Repeat the procedure just described for programming additional Segments.

TUTORIAL END

PROGRAMMING A SESSION TUTORIAL

We will now go through the steps needed to put SHOW 1 that we just programmed into a Session that will start at 10:30 on a 12th October 1998.

Press the PROGRAM SESSION softkey in the Menu screen. The screen will look like this:

```
Programming Sessions for: 2/8/99
(Use SCROLL knob to select date)

COPY                OK        EXIT
```

Now **select the date** that you wish to the show to be programmed using the scroll control and then press the **OK** softkey. (Pressing the EXIT softkey will return you to the Menu screen). If the Date that you selected has not previously been programmed, the screen will look like this:

```
Programming Sessions for: 7/8/99
Session: 01 SESSION NOT PROGRAMMED

TIME    INSERT    DELETE    STORE    EXIT
```

Use the scroll control to **select the Session** number (01) and press STORE.

Using the Show # keys **select the Show** number (Show 1) and press STORE.

Now we will **set the start time**, press the TIME softkey and then use the SCROLL to set the time to 10:30. Press STORE. The screen should look like...

```
Programming Sessions for: 7/8/99
Session: 01 10:30 SHOW# 01

TIME    INSERT    DELETE    STORE    EXIT
```

You may want to program the show to start at certain times during the day (12:30, 14:30, 16:30, 18:30, 20:30) if so repeat the above process. The automation will now start by itself at these times. All that the projectionist needs to do is, thread up the projector at the conclusion of each session so that it is ready for the next session.

If you do not wish to program any more sessions press EXIT.

TUTORIAL END

A SAMPLE PROGRAM WITH ONLY ONE SEGMENT

The following program runs a slide show, then trailers in wide screen, stereo which is followed by a feature in scope, SR. At the end of the feature it shuts everything down, closes the curtains, raises the lights and resets the lens and masking to wide screen. It rewinds the tape and resets the slides ready for the next show.

This program assumes that your Default Settings have been stored as the following:

PROJECTOR	OFF	XENON	OFF
PICTURE	OFF	LENS	WIDESCREEN
SLIDE	OFF	TAPE	STOPPED
CURTAIN	CLOSED	MASKING	WIDESCREEN
HOUSE LIGHTS	UP	CURTAIN LIGHTS	UP
SOUND	NON-SYNC 1	VOLUME	50

Event 1

TRIGGER	MANUAL	manual or timer start
SLIDE	SLI-RST	reset the slide machine's carousel to position "0". If a slide is in the gate, open the shutter
TAPE	TAPE-PL	play the tape
CURTAIN	CURT-OP	open the curtain
LIGHTS	HSLT-P1	dim house lights to preset 1
LIGHTS	CNLT-DN	fade curtain lights out
SOUND	NSYNC-2	switch the sound processor to the tape input
VOLUME	VOL-45	set the volume to 45

Event 2

TRIGGER	LAST SL	detect the last slide
PROJECTOR	PRJ1-ON	turn the projector motor on
XENON	XEN1-ON	turn the xenon on

Event 3

TRIGGER	CNTRCUE	detect the centre cue on the film at start of trailer
PICTURE	PIC1-ON	put the picture on the screen
SLIDE	SLID-OF	turn off the slide machine
TAPE	TAPE-RWD	rewind the tape
LIGHTS	HSLT-P2	dims the house lights to preset 2
SOUND	STEREO	change the sound to film stereo
VOLUME	VOL-60	set the volume to 60

Event 4

TRIGGER	CNTRCUE	detect centre cue at the start of the feature on the film
LENS	LENS-SC	change the lens and masking to scope for the feature
LIGHTS	HSLT-DN	turn the house lights down
SOUND	STEREOSR	set the sound processor to stereo SR
VOLUME	VOL-70	set the volume to 70

Event 5

TRIGGER	CENTRE CUE	detect the centre cue at the start of the credits on the film
LIGHTS	HSLT-P2	raises the house lights to preset 2

Event 6

TRIGGER	CENTRE CUE	detect the centre cue before the end of the credits on the film
CURTAIN	CURT-CL	close the curtains
LIGHTS	HSLT-UP	turn the house lights up
LIGHTS	CNLT-UP	turn up the curtain lights

Event 7

TRIGGER	CENTRE CUE	detect the centre cue at the end of the feature's credits
PICTURE	PIC1-OF	takes the picture off the screen
LENS	LENS-WS	change the lens back to wide screen
MASKING	MASK-WS	change the masking back to wide screen
SOUND	NSYNC 1	change the sound back to non sync 1
VOLUME	VOL-50	set the volume to 50

Event 8

TRIGGER	WAIT-30	wait 30 seconds for the film to run out of the projector
PROJECTURE	PRJ1- OF	turn the projector motor off
XENON	XEN1-OF	turn off the xenon lamp

END

A SAMPLE PROGRAM WITH SEVERAL SEGMENTS

This is the same program as above, but broken into 4 Segments – Slides, Trailers, Feature and Closer.

Programming for multiple segments makes later editing easier and allows many show combinations to be set up with just a few Segments. This method is easier to understand if you check the each of the equipment control screens while you are programming to ensure that the equipment is in the correct state for each Event.

SEGMENT 1

SLIDES1

Event 1

TRIGGER	MANUAL	manual or timer start
SLIDE	SLI-RST	reset the slide machine's carousel to "0". If a slide is in the gate, open the shutter
TAPE	TAPE-PL	play the tape
CURTAIN	CURT-OP	open the curtain
LIGHTS	HSLT-P1	dim house lights to preset 1
LIGHTS	CNLT-DN	fade curtain lights out
SOUND	NSYNC-2	switch the sound processor to the tape input
VOLUME	VOL-45	set the volume to 45

SEGMENT 2

START-PR

Event 1

TRIGGER	LAST SL	detect the last slide
PROJECTOR	PRJ1-ON	turn the projector motor on
XENON	XEN1-ON	turn the xenon on

SEGMENT 3	TRAILER1	(Wide screen, Stereo)
Event 1		
TRIGGER	CNTRCUE	detect the centre cue on the film at start of trailers
SLIDE	SLID-OF	turn off the slide machine
TAPE	TAPE-RWD	rewind the tape
PICTURE	PIC1-ON	put the picture on the screen
CURTAIN	CURT-OP	open the curtain
LIGHTS	HSLT-P2	dim the house lights to preset 2
LIGHTS	CNLT-DN	fade curtain lights out
SOUND	STEREO	change the sound to film stereo
VOLUME	VOL-60	set the volume to 60
SEGMENT 4	FEATURE3	(Scope, SR)
Event 1		
TRIGGER	CNTRCUE	detect the centre cue on the film at start of the feature
LENS	LEN1-SC	change the lens to Scope
MASKING	MASK-SC	change the masking to Scope
PICTURE	PIC1-ON	put the picture on the screen
SLIDE	SLID-OF	the slide machine should be off (in case you run without trailers)
LIGHTS	HSLT-DN	fade the house lights out
LIGHTS	CNLT-DN	the curtain lights should be off
SOUND	STEREOSR	change the sound to film stereo SR
VOLUME	VOL-60	set the volume to 70
SEGMENT 5	CLOSER1	
Event 1		
TRIGGER	CNTRCUE	detect the centre cue on the film at start of the credits
LIGHTS	HSLT-P2	raise the house lights to preset 2
Event 2		
TRIGGER	CNTRCUE	detect the centre cue on the film before the end of the credits
LIGHTS	HSLT-UP	raise the house lights
CURTAIN	CURT-CL	close the curtain
LIGHTS	CNLT-UP	raise the curtain lights
PICTURE	PIC1-OF	turn the picture off
SOUND	NSYNC1	change the sound to non sync 1
VOLUME	VOL-40	set the volume of the non-sync to 40
Event 3		
TRIGGER	CNTRCUE	detect the centre cue on the film at end of the credits
MASKING	MASK-WS	set the masking back to wide screen
LENS	LENS-WS	set the lens back to wide screen
Event 4		
TRIGGER	WAIT-30	wait for the film to run out of the projector
PROJECTOR	PRJ1-OF	turn the projector motor off
XENON	XEN1-OF	turn the xenon off

END

At the end of the show, the settings for the equipment should be the same as they were before the show started.

SYSTEM INSTALLATION

The CA2000 automation card set has been designed for high immunity from external interference and can be installed in virtually any location. An optional metal case is available for installation in open areas. Care should be taken however when connecting to the A-D inputs and D-A outputs, as external noise may be permitted to enter the AI² system via external connecting wires. All A-D and D-A connections should be made using shielded cable. The cable shield should be connected to an external ground. If the AI² is mounted in the optional metal case the shield can be connected to the case.

When high current inductive loads are being switched by the output relays, some crosstalk into the relay drive circuitry may occur due to inductive coupling between relay contacts and coil. Under such circumstances it is advisable to connect a suppression capacitor across the relay contacts to reduce the energy of the switching spike.

SYSTEM CONNECTION

The standard CA2000 system consists of two relay cards, an AS101 and an AS103 as well as the RC140 Control Panel. The system is connected as shown in Figure 1.

The main power supply for the system is located on the AS101 relay card, the AS101 requires a mains voltage of either 115 or 240 volts. This is supplied to the AS101 via the supplied IEC mains lead.

CAUTION: Mains voltage present on the underside of the AS101 card.

The AS103 Relay Extender card is connected to the AS101 relay card via a 26-pin IDC cable, which is also supplied. Additional Extender relay cards may be required in some installation and are also connected by a 26-pin IDC cable that is supplied with the additional card.

The RC140 Control Panel is connected to the AS101 card using the supplied 9 pin serial cable, the cable connects between the "RELAY CARD CONTROL" 9 Pin D-connector on the RC140 Control panel and the "SERIAL INPUT" 9-Pin D-connector on the AS101 Relay Card.

IMPORTANT: Do not connect any other equipment to the AS101 Relay Card serial connector "J5" as the voltage present on Pin 1 may damage the serial port on the other equipment.

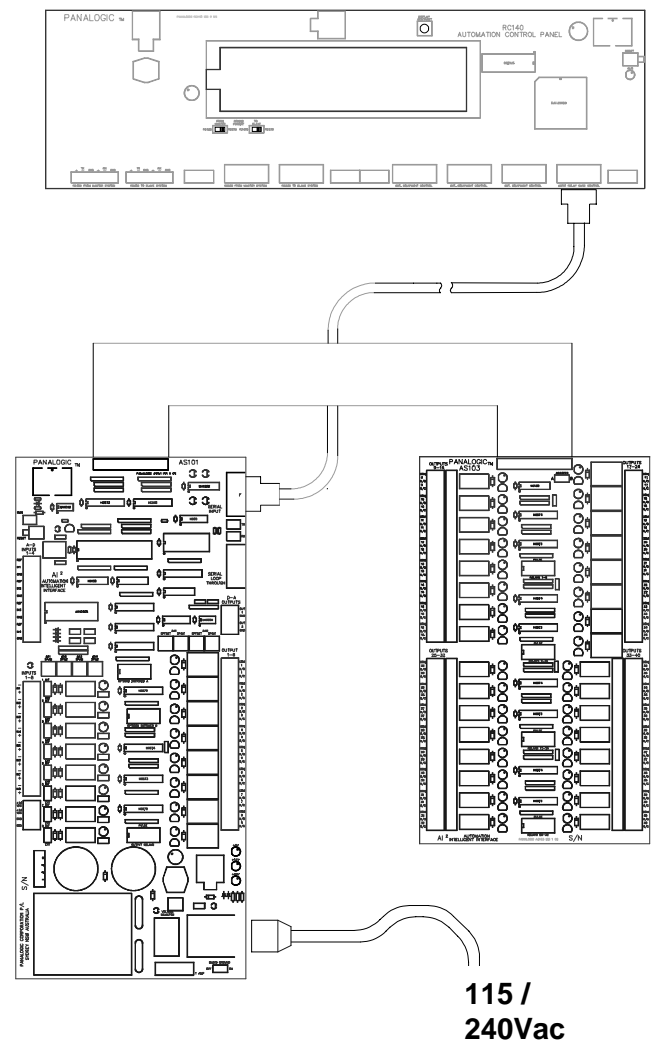
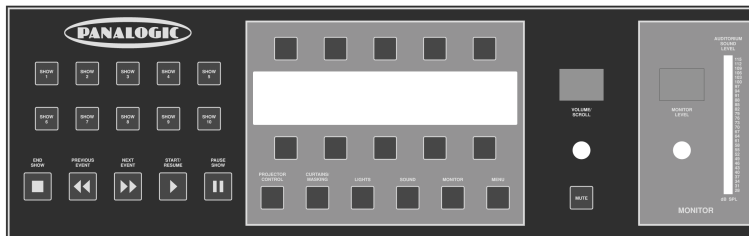

Figure 1 – CA2000 Connection Diagram

RC140 CONTROL PANEL

The connectors on the rear of the RC140 Control Panel are used for serial communication of external equipment, they are divided into two groups, Local which controls the cinemas serially controlled equipment and Network which allows communication between CA2000s, status panels or a PC.



LOCAL SERIAL CONNECTIONS

The CA2000 supports serial control of many Cinema related products including dimmers, slide machines, sound processors and monitors. Protocols are continually being added to the CA2000 as more serially controlled equipment becomes available. See the supported serial equipment list in the appendix of this manual.

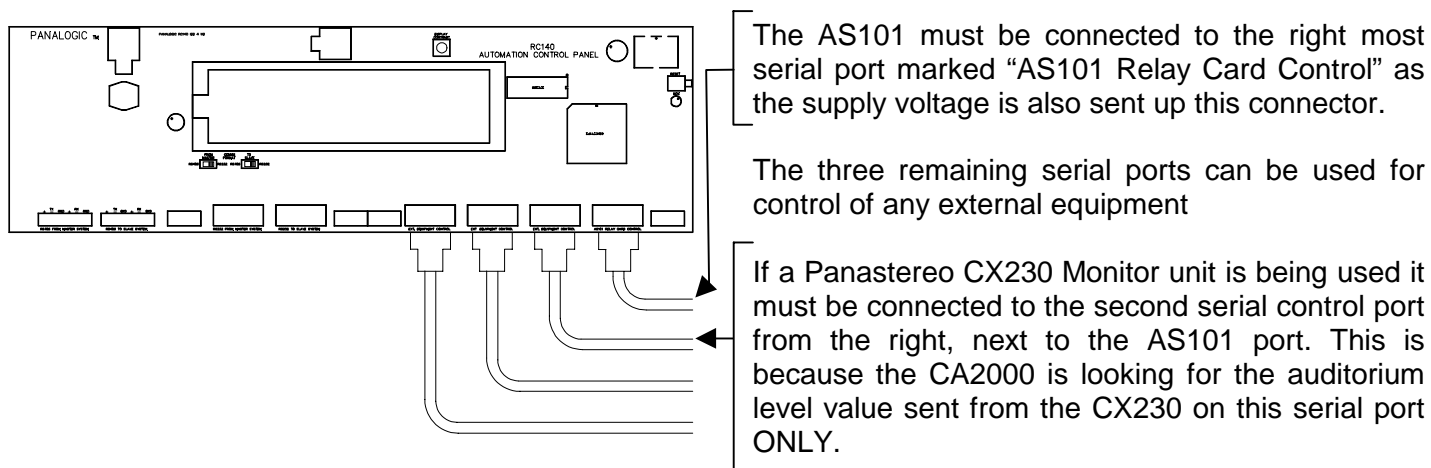

Figure 2 – RC140 Local Connections

Connection to the AS101 Relay Control Card.

If a new RC140-AS101 cable needs to be made because the supplied cable is not long enough or the cable needs to be threaded through ducting, please take note of the following connection information.

The AS101 Relay Control card is connected to the RC140 control panel via a shielded 4-core cable. The cable must be wired for one to one connection of pins 1, 2, 3 and 5. Pins 2 and 3 carry the TX and RX data signals for communication between the RC140 and the AS101. Pin 1 carries the 15-volt power supply for the RC140 and Pin 5 is the ground circuit. A standard serial cable that has all 9 pins connected may also be used.

Serial Connection to External Equipment.

Most RS232 serially controlled equipment is configured as a DCE device (Data Circuit Terminating Equipment) and can be connected using a pin for pin, male to female 9-pin standard computer serial cable.

However DTE devices (Data Terminal Equipment) such as Personal Computers or laptop computers will require a 'null modem' cable connection.

NETWORK CONNECTIONS

Up to 32 individual CA2000 automation systems may be connected together in a network loop to allow interlocking, control and monitoring from a central computer and/or multi-cinema status display. The CA2000 is also able to transfer session and program data across the network.

Each RC140 panel includes two network serial data ports, each of which may be configured to use either 3 wire RS232, or 4 wire RS485 protocol. RS485 provides superior transmission quality and immunity to noise compared with RS232, particularly over long cable runs, due to the fact that it uses balanced low impedance lines. However RS232 is more than adequate for typical cinema to cinema connections where the cable length does not exceed about 15 metres.

SELECTING NETWORK SERIAL PORT PROTOCOL

The two network serial ports are located at the rear of the RC140 control panel, at the end furthest from the microprocessor(s). The two ports are labelled "From Master" and "To Slave". The "From Master" port has a female D9 connector and the "To Slave" port has a male D9 connector. Both ports also each have a 6 pin Phoenix RS485 connector.

There are two slide switches marked "COMMS FORMAT", one for each port. Each switch allows protocol selection for that port. The switches only affect the data receive function, the transmit functions are active for both protocols at all times.

INTER-CONNECTING AUTOMATION UNITS

Multiple automation systems are connected together using a "**Daisy-chained**" loop arrangement.

The "To Slave" port of the first unit should be connected to the "From Master" port of the second unit, and the "To Slave" port of the second unit should be connected to the "From Master" port of the third unit, and so on.

Both ports ("From Master" and "To Slave") are functionally identical, however the RS232 transmit and receive pins are reversed. Therefore, if the above connection method is used, a standard pin-for-pin cable may be used. However if a "To Master" RS232 port is connected to another "To Master" RS232 port, or if a "To Slave" RS232 port is connected to another "To Slave" RS232 port, the TX and RX pins (2 & 3) must be reversed at one end of the cable (null modem cable).

The RS232 serial port of a PC (Personal Computer) or a laptop computer may be connected to either end of the Daisy chain. However if the connection is to a "To Slave" port it will require a D9 female to female cable with pins 2 & 3 crossed over at one end (female null modem cable).

A status panel may also be connected to either end of the Daisy chain, however if the connection is to a "To Master" port it will require a D9 male to male cable with pins 2 & 3 crossed over at one end (male null modem cable).

USING MIXED PROTOCOLS

It is possible to use mixed protocols anywhere in the loop provided the protocol is the same at both ends of each cable connection. For example a PC may be connected to the first automation using RS232 whereas the rest of the daisy chain from one automation to the next may be connected using RS485.

CONNECTING A STATUS PANEL TO THE MIDDLE OF THE DAISY CHAIN.

A Panalogic status panel may be connected to any automation along the daisy chain loop, provided the loop has been wired using RS485 protocol. The status panel cable should be connected to the "To Slave" RS232 connector and only to the transmit function (pins 3 and 5). Pin 2 must remain disconnected. The protocol select switch for the "To Slave" port should remain in the RS485 position.

A status panel connected in this way will operate normally except if the power to the status panel is interrupted, in which case the status panel will only display the status of cinemas that have changed their status since power was restored to the status panel.

CABLE SELECTION AND WIRING

It is recommended that **4-core shielded cable** be used for RS232 and RS485 connections.

RS232 CONNECTIONS:

Use the first conductor for Transmit Data (pin 3), the second conductor for Receive Data (pin 2) and the third conductor for Ground (pin 5). The fourth conductor is unused. Connect the shield also to pin 5 but only at one end of the cable.

Cables should use a Male D9 connector at one end and a Female D9 connector at the other end. If the connectors are the same sex at each end, pins 2 & 3 should be crossed over at one end (null modem cable).

The female Network connector, marked "RS232 FROM MASTER SYSTEM" is connected to the previous CA2000 or central computer and the male Network connector marked "RS232 TO SLAVE SYSTEM" is connected to the next CA2000 or monitor panel.

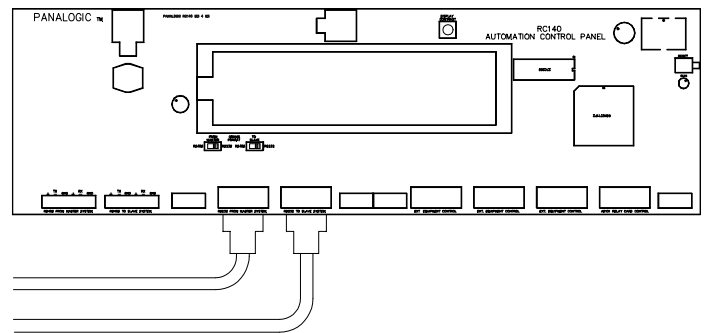

Figure 3 – Network RS232 Connections

RS485 CONNECTIONS

Use the first conductor for Transmit "+", the second conductor for Transmit "-", the third conductor for Receive "+" and the fourth conductor for Receive "-". The shield should be connected to the "E" terminal at one end of the cable only.

The **Transmit pins** for each port should be connected to the corresponding **Receive pins** of the port at the other end of the cable. ie The TX positive and negative from the Master connects to RX positive and negative at the Slave and vice versa.

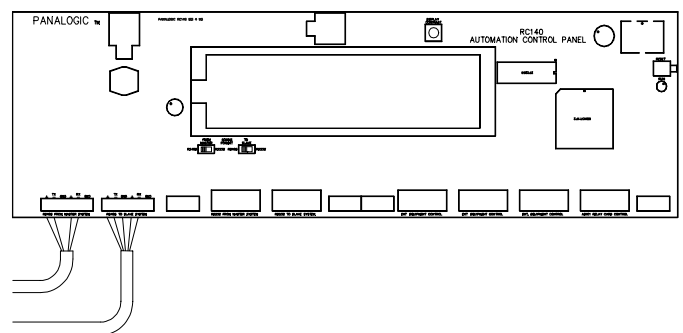

Figure 4 – Network RS485 Connections

The RS485 Network connector, marked "RS485 FROM MASTER SYSTEM" is connected to the previous CA2000 and the RS485 Network connector marked "RS485 TO SLAVE SYSTEM" is connected to the next CA2000.

AS101 & AS102 INPUT AND OUTPUT INFORMATION

Input Relay Connection Options

The input relays can be driven by the internal power supply or by any external 17 - 30V power supply. If the internal supply is to be used, select the INT/EXT switch located adjacent to the relay to the INT position. Shorting the relay input terminals will then activate the relay.

If an external supply is to be used, switch the INT/EXT switch to EXT. Applying 17 - 30 volts across the relay input terminals will activate the relay. The external voltage can be either positive or negative.

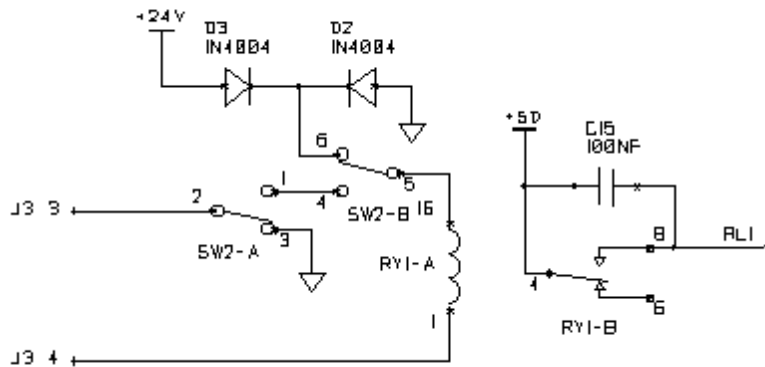

Figure 5 – Input Relay Circuit

A-D Input Connections

Each A-D input terminal has an associated voltage reference output terminal immediately above it and a ground terminal immediately below. The A-D input voltage range can be adjusted using the SPAN trimpot. With the span control at maximum, an input voltage of 5 volts will produce a digital value of 255 (max). If higher input voltages are to be accommodated the SPAN control should be turned counter-clockwise so that the maximum input voltage produces a digital value of 255.

D-A Output Connections

Each D-A output terminal has a ground terminal immediately below it. The SPAN control sets the output voltage when the digital code is at maximum (255). The SPAN control can be adjusted for an output voltage at maximum code of between 0 and +10 volts. The OFFSET adjustment sets the output voltage when the digital code value is at minimum (zero). The OFFSET control can be adjusted for an output voltage at minimum code of between 0 and +10 volts.

The SPAN and OFFSET adjustments are non-interactive so each can be adjusted without affecting the other. For a voltage span of 0 to +10v the OFFSET control should be set fully anticlockwise and the SPAN control fully clockwise. If these positions are reversed the output voltage will range from +10V to 0V (ie. reduce with increasing digital code).

Output Relay Connections

Each high power output relay (Outputs 1-8) has one set of changeover contacts. These are (from the top down) common, normally open and normally closed. The relay contacts are rated at 5A 250Vac or 150Vdc.

SETTING THE OPTIONS SWITCHES ON THE AS101 RELAY CONTROL CARD

OPTIONS SWITCH BANK "A"

The Options Switch Bank "A" is marked "OPTIONS SWITCHES A" and is the top switch bank on the AS101 control card.

Switches 1-2 not currently used.

Switch 3 sets the analogue sound level ramp time.

Switch 4 forces the pulse duration of the slide on/off relay to 5 seconds.

Switch 5 sets input relay 1 to outboard cue or motor on/off sense.

Switch 6 switches Panastereo Monitor to surround in Non-Sync.

Switch 7 not currently used.

Switch 8 enables the control screens for a second projector.

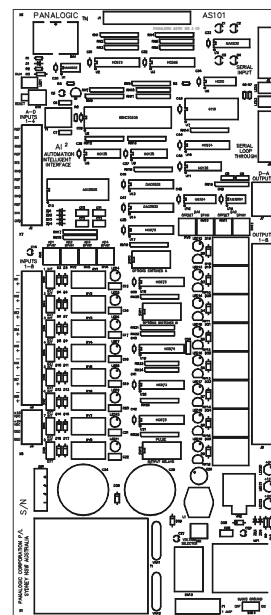

SWITCH 3 – Analogue Sound Level Ramp Time.

Setting this switch to 'ON' sets the analogue sound level (D to A) ramp time to Slow (5 seconds) and 'OFF' sets the ramp time to Fast (1 second).

SWITCH 4 - Slide Relay Pulse Length.

Setting this switch to 'ON' forces the pulse time of the slide on/off relay from 'the 'global' setting to 5 seconds provided that the pulse option for the relay on the AS103 card is set to pulse.

SWITCH 5 - Input Relay #1 Function.

Setting this switch to 'OFF' will configure Input Relay #1 on both the AS101 and the AS102 (2 projector operation) as an "outboard foil cue" input.

Setting this switch to 'ON' will configure Input Relay #1 on both the AS101 and AS102 (2 projector operation) as a projector motor status sense input. In this mode an external contact closure controlled by the projector motor manual switches can be used to update the automation if the projector is started or stopped by the manual projector switches which are external to the automation.

SWITCH 6 - Monitor to Surround in Non-Sync option.

When Switch 6 is set to the 'ON' position, the attached Panastereo monitor will switch to Left Surround whenever Non-Sync 1 is selected. This is for use when the sound processor has been configured so that the house music (Non-Sync 1) is sent to the surround speakers only. This option ensures that the Non-Sync 1 sound is always audible in the monitor. When any other format is selected the monitor will switch back to the MIX position.

SWITCH 8 - Enable Two Projector Operation.

When Switch 8 is set to the 'ON' position, the control of a second projector using the optional AS102 relay card is enabled.

OPTIONS SWITCH BANK "B"

The Options Switch Bank "B" is marked "OPTIONS SWITCHES B" and is the middle switch bank on the control card.

- Switches 1-2 select the output relay pulse time.
- Switches 3-4 select turret rotation delay time.
- Switches 5-7 invert the fault sensing inputs.
- Switch 8 selects single button lens turret.

SWITCHES 1-2 – Global Relay Pulse Time.

The Global Relay Pulse Time can be varied from 1/4 second to 2 seconds by setting switches 1 and 2 on the Option Switches B switch bank. The Pulse Time options are as follows:

PULSE TIME	SWITCH 1	SWITCH 2
250mS	OFF	OFF
500mS	ON	OFF
1S	OFF	ON
2S	ON	ON

SWITCH 3-4 - Turret Rotation Delay Time.

This setting delays the start of the turret rotation from the start of the zipper closing. Some projectors, such as the Vic 5 and the Bauer U3 have a slow operating picture on / off mechanism (zipper). If the zipper has not closed fully before the lens starts to change, you may get a moving image on the screen. The turret rotation for lens changing needs to be delayed until the zipper has had time to close.

DELAY TIME	SWITCH 3	SWITCH 4
250mS	OFF	OFF
500S	ON	OFF
750mS	OFF	ON
1S	ON	ON

Inverted Fault Sensing

Option B switches 5, 6 and 7 invert the fault sensing relays. This will require the relays to be ON for no fault.

SWITCH 5 - Platter Fault Input Invert.

SWITCH 6 - Xenon and Exciter Input Fault Invert.

SWITCH 7 - Fire Fault Input Invert.

SWITCH 8 - Single-Button Lens Turret option.

The automation will normally control a typical two-button lens turret such as the Kelmar unit. Single-button turrets such as Cinemeccanica can be controlled by setting Options B Switch 8 to the ON position. In this mode Relay 7 acts as a pulsing relay for both Wide Screen and Cinemascope. Relay 8 is inactive. The two lens sense input relays (Input Relays 7 & 8) are required to be connected to the turret position sense switches so that the automation knows which lens is selected. In addition, the WS lens relay needs to be set to for pulse operation.

OUTPUT RELAY PULSE FEATURE

The Output Relays are normally turned on or turned off (latching) by the automation software. It is also possible to select pulsed operation for each relay by setting the PULSE switches on the control card and the I/O sub cards. Thus, when a "turn on" command is sent from the RC140, the relay will switch off again after a short period. To select output relay pulsing, set the appropriate PULSE switch to the ON position. The Pulse selection switches are the red DIP switch bank at the bottom of the AS101 Relay Control card. The switch code is SW12 and is labelled "pulse output relays".

INSTALLING THE RELAY EXPANDER CARDS

In its standard configuration the CA2000 incorporates one relay expander card, the AS103. If the system is to be installed in a dual projector installation a second relay expander card is required to control the second projector, the AS102.

The AS103 expander card has 24 low power relay outputs (9-16 and 25-40) and 8 high power relay outputs (17 - 24). The AS102 expander card has 8 low power relay inputs (9-16), 16 low power relay outputs (17-32) and 8 high power relay outputs (9-16).

Each high power output relay has one set of changeover contacts. Each low power relay has two sets of changeover contacts. The outer terminal strip has one set of changeover contacts and the inner terminal strip (if loaded) has the other.

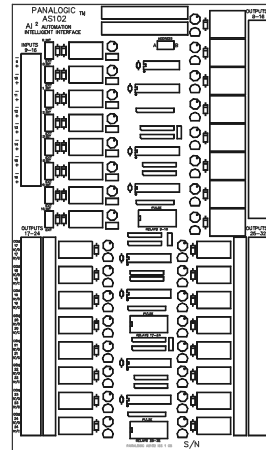

AS103

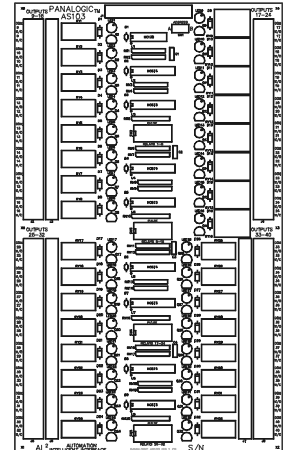

Optional AS102

Card Address

Each relay expander card has an address switch that needs to be set, for the CA2000 system the AS103 card must be set to address A and the optional AS102 to address B if required. If the two cards are set to the same address they will mimic each other's outputs, if they are both set to address B the inputs on the AS101 will work and the output 9-18 on the AS103 will not.

Output Relay Pulse Feature

Each relay expander card output relay has an output relay pulse feature the same as the output relays on the AS101. To select output relay pulsing, set the appropriate PULSE switch to the ON position.

OUTPUT RELAY CONFIGURATION

Main Card (AS101) Output Relays

- 1 = XENON ON
- 2 = XENON OFF
- 3 = PROJECTOR ON
- 4 = PROJECTOR OFF
- 5 = ZIPPER OPEN
- 6 = ZIPPER CLOSE
- 7 = WIDESCREEN LENS SELECT
- 8 = SCOPE LENS SELECT

Expander Card (AS103) Output Relays

- 9 = AUXILIARY 1 (User defined)
- 10 = AUXILIARY 2 (User defined)
- 11 = AUXILIARY 3 (User defined)
- 12 = AUXILIARY 4 (User defined)
- 13 = AUXILIARY 5 (User defined)
- 14 = AUXILIARY 6 (User defined)
- 15 = AUXILIARY 7 (User defined)
- 16 = AUXILIARY 8 (User defined)

- 17 = CURTAIN OPEN
- 18 = CURTAIN CLOSE
- 19 = MASKING OPEN
- 20 = MASKING CLOSE
- 21 = SLIDE MACHINE ON/OFF
- 22 = SLIDE ADVANCE
- 23 = TAPE MACHINE PLAY
- 24 = TAPE MACHINE REWIND

- 25 = HOUSE LIGHTS UP
- 26 = HOUSE LIGHTS PRE-SET 1
- 27 = HOUSE LIGHTS PRE-SET 2
- 28 = HOUSE LIGHTS DOWN
- 29 = CURTAIN LIGHTS UP
- 30 = CURTAIN LIGHTS PRE-SET 1
- 31 = CURTAIN LIGHTS PRE-SET 2
- 32 = CURTAIN LIGHTS DOWN

- 33 = MONO
- 34 = STEREO
- 35 = STEREO SR
- 36 = DIGITAL
- 37 = MAGNETIC
- 38 = NON-SYNC 1
- 39 = NON-SYNC 2
- 40 = MUTE

Digital To Analogue Converter Outputs

- 1 = ANALOGUE VOLUME CONTROL
- 2 = ANALOGUE MONITOR VOLUME

INPUT RELAY CONFIGURATION

Main Card (AS101) Input Relays

- 1 = OUTBOARD FILM CUE/ MOTOR STATUS
- 2 = INBOARD FILM CUE
- 3 = CENTRE FILM CUE
- 4 = LAST SLIDE CUE / SLIDE ADVANCE PULSE
- 5 = PLATTER / TENSION FAULT
- 6 = FIRE FAULT
- 7 = FLAT LENS SENSE
- 8 = SCOPE LENS SENSE

Analogue To Digital Converter Inputs

- 1 = PROJ 1 - XENON FAULT
- 2 = PROJ 2 - XENON FAULT
- 3 = PROJ 1 - EXCITER FAULT
- 4 = PROJ 2 - EXCITER FAULT

OPTIONAL AS102 RELAY ALLOCATIONS

The AS102 is only required for use in dual projector installation for control of the second projector.

Expander Card (AS102) Input Relays

- 1 = OUTBRD FILM CUE/MOTOR SENSE (Proj 2)
- 2 = INBOARD FILM CUE (Proj 2)
- 3 = CENTRE FILM CUE (Proj 2)
- 4 = LAST SLIDE CUE / SLIDE ADVANCE PULSE
- 5 = PLATTER / TENSION FAULT
- 6 = FIRE FAULT
- 7 = FLAT LENS SENSE (Proj 2)
- 8 = SCOPE LENS SENSE (Proj 2)

Expander Card (AS102) Output Relays

- 9 = XENON ON (Proj 2)
- 10 = XENON OFF (Proj 2)
- 11 = PROJECTOR ON (Proj 2)
- 12 = PROJECTOR OFF (Proj 2)
- 13 = ZIPPER OPEN (Proj 2)
- 14 = ZIPPER CLOSE (Proj 2)
- 15 = WIDESCREEN LENS SELECT (Proj 2)
- 16 = SCOPE LENS SELECT (Proj 2)

Note: All other AS102 relays are not used with the CA2000 system.

APPENDIX

SERIALLY CONTROLLABLE PRODUCTS

Sound Processors

Panastereo CSP1200
Panastereo CSP3200
Panastereo CSP4200
Dolby CP500

Slide Projectors

Kodak Ektapro 4010
Kodak Ektapro 5010
Kodak Ektapro 7010
Kodak Ektapro 9010
Simda 3245
Simda 3262
Simda 3445
Simda 2462

Mini-Disk Players

Sony MDS-E11
Sony MDS-E52
Sony MDS-B6P
Tascam MD-801

Cinema Monitors

Panastereo CX230EX

Lighting Dimmers

Dynalite (All models)

Please Note: The above list is continually growing as more and more serially controllable devices become available. For an up to date list please contact your Panalogic dealer or www.panalogic.com.

Serial Data Cables

It is important to make sure that the foil screens of any data cables are connected to ground at one end to enable the screens to be effective.

Connection to a Panastereo Sound Processor

The RC140 should be connected to a CSP3200, CSP4200 or CSP1200 sound processor using a standard 9 pin serial cable. Only pins 2, 3 and 5 are used. The cable connects to one of the D9 sockets at the back of the RC140 panel marked "EXT. EQUIPMENT CONTROL". The other end of the cable connects to the D9 socket at the back of the Panastereo Processor marked "SERIAL AUTOMATION INTERFACE". DO NOT connect the cable to the Remote Control connector.

Serial Control of a Dolby CP500

Dolby CP500 sound processors use a bi-directional single data line RS-232 protocol to communicate with the Cat.689 remote control unit. This feature can be used to interface with the Panalogic automation system using the following connection method:



Connection to a Panastereo CX230 Monitor Unit

The RC140 can be connected to a Panastereo CX230 monitor unit using a standard 9-Pin serial cable. Only Pins 2, 3 and 5 are used. The cable must connect to the second D9 connector socket (J4) at the back of the RC140 panel, next to the one marked "AS101 RELAY CARD CONTROL". The other end of the cable connects to the RS232 serial port (9-Pin D-connector) at the back of the CX230 monitor unit.

Serial Control of Tascam Mini Disk Players

The serial control of Tascam Mini Disk players is currently supported however due to limitations of the Tascam protocol it is not recommended if other serial equipment is also being used on the same serial loop.

Connection to a Slide Machine with a Serial Data Interface

A Kodak Ektapro 5000 slide machine (or other slide machine with a serial data interface) can be connected using serial data to the RC140. The connection is made using a standard 9-Pin serial cable. Only pins 2, 3 and 5 are used. The cable connects to any of the sockets at the back of the RC140 marked "EXT. EQUIPMENT CONTROL".

Serial Control of Lighting Dimmers

The CA2000 is capable of controlling Dynalite dimmers serially. Since Dynalite dimmers use RS485 protocol and the CA2000 communicates using RS232 the connections are not pin for pin, connect using the following method:



INSTALLATION NOTES AND SUGGESTIONS

Output Relay Load Restrictions

The high power output relays (Outputs 1-8 , 9-16 , 17-24) are quite suited for controlling 240 volt AC loads directly up to several amps. Zippers and mains contactors are fine. Small single-phase projector motors rated less than 1 hp are fine but 3 phase motors, larger projector motors and large inductive loads will require external contactors suitably rated.

Variable speed motor controllers should be 'soft' controlled, as the mains inrush current when switched on can be very high. These controllers usually have internal contacts for turning the output on and off and these should be used.

Some slide projectors such as the Kodak SAV require additional relays or 'SAV adaptors' to switch their lamps .The lamp current can be 10 to 20 amps which is far in excess of the capacity of the Panalogic output relays.

Grounding Requirements

It is most important that the lamp house, xenon rectifier units, projectors and dimmer units be properly earthed. The RF voltage generated by some ignition striker units has been known to cause problems with some types of external equipment. Projectors can make clicks and dimmers can generate buzzes in sound systems if not earthed properly.

Manual Backup System

The AS101 and AS103 output relays are usually wired across (in parallel with) the existing manual control switches in the cinema equipment. We strongly recommend that manual controls should be available to the

operators for all essential controls to allow emergency manual operation in the unlikely event of a failure of the automation system.

Slide Machine “Last Slide” Detection

The CA2000 provides two alternative ways to detect when the last slide of a slide show is in the slide projector gate.

The first method involves physical detection using a foil sensor. With this method a proximity sensor is mounted on the slide machine in such a position as to detect a foil strip mounted on the slide carousel adjacent to the last slide. The sensor is connected to the Last Slide input relay and the “number of slides” in the automation Show Setup screen set to zero. The disadvantage of this method is that the foil strip must be moved whenever the number of slides in the carousel is increased or decreased.

The second method uses a connection from an external slide forward pulse unit to the last slide input relay. The “number of slides” in the automation Show Setup screen is then set to however many slides are currently in the carousel. The automation then counts the slide advance pulses from the pulse unit and issues a last slide cue when the last slide enters the gate. With serially controlled slide machines for each pulse the slide machine is advanced by the automation. This can also be done with parallel controlled machines using the slide advance output relay on the AS103 card. This eliminates the need for a direct pulse connection from the pulse unit to the slide machine and allows slide advance commands to be programmed into shows.

AS101 / AS102 Input Relay 1

This relay is configurable as either an outboard cue input relay or as a projector motor status relay. As an outboard cue input relay, it functions the same as the other cue sensor input relays. As a projector motor relay it functions as follows. If the projector motor status changes (the motor is started or stopped by the manual projector controls) the automation will track this change. Mainly used during interlock so if one of the projectors is started or stopped manually, they all will start or stop. As the relay is low voltage, it will require either a spare set of contacts on the projectors’ motor relay or it will require a (240vac) relay across the motor to sense the motor status, this relay would then control the input relay #1.

Xenon and Exciter Fault Detection.

Several methods may be used to sense a xenon or exciter lamp failure. For lamp failure detection the most common method uses a phototransistor mounted inside the lamphouse, usually behind the mirror in the case of a xenon to avoid direct exposure to the lamp. The collector of the phototransistor is connected to the REF (reference) terminal of the appropriate A to D input and the emitter to the IN (input) terminal. When the lamp is on, the transistor will conduct, causing the IN terminal to go high and when the lamp is off the transistor will turn off causing the IN terminal to go low. With this connection the xenon/exciter fault mode should be configured for inverted operation as the fault is active when the input is high. Ideally, a blue filter should be placed in front of the phototransistor lens to reduce the amount of infrared (heat energy) entering the lens and thus speed up the reaction to lamp failures. The A to D input sensitivity should be adjusted so that the output level from the A to D is about 140 when the lamp is on. See the section entitled SETTING UP THE A-D LEVELS FOR XENON / EXCITER FAULTS in the System Setup chapter of this manual.

If the exciter fault input is not used in inverted mode, be sure to tie the input high and set the span control to maximum (fully clockwise) to prevent exciter faults from occurring.

Another method uses an LDR (light dependent resistor). This device has a low resistance when exposed to light and a high resistance when not exposed to light. An LDR can be connected in the same way as a phototransistor, as described above.

AUXILIARY CONTROL	2.6	DUAL PROJECTOR OPTION SWITCH	6.6
CINEMA NUMBER	3.2	PROGRAMMING PROJECTOR FUNCTIONS	5.14
CUES	SEE TRIGGERS	RELAYS	
CURTAINS		INPUT RELAY CONNECTIONS	6.5
CURTAIN CONTROL	2.5	OUTPUT RELAY CONNECTIONS	6.5
PROGRAMMING	5.15	PULSE OUTPUT RELAYS	6.7, 6.8
DEFAULT SETTINGS	3.1	RELAY LOAD RESTRICTIONS	7.2
DIMMERS		SETTING RELAY PULSE TIME	6.7
SETTING PRESET LEVELS	3.5	SAMPLE PROGRAM	5.20, 5.21
EVENTS		SEGMENTS	
CHANGING EVENTS IN A SHOW	4.3	EDITING	5.3
STEPPING THROUGH PROGRAMMED EVENTS	4.2	PROGRAMMING	5.1
WHAT IS AN EVENT?	1.1	PROGRAMMING TUTORIAL	5.4, 5.13
FAULTS		WHAT IS A SEGMENT?	1.1
FILM TENSION/PLATTER	3.7	SESSIONS	5.8
FIRE ALARM	3.8	SETTING THE TIME AND DATE	3.1
INVERTING FAULT SENSING	6.7	SHOW	
SEGMENTS	3.9	EDITING A SHOW	5.7
XENON	3.8	PAUSING A SHOW	4.2
INSTALLATION		PROGRAMMING	5.1, 5.6
AS101 & AS103 RELAY BOARDS	6.1, 6.5	PROGRAMMING TUTORIAL	5.18
RC140 CONTROL PANEL	6.2	RUNNING A SHOW	4.1
INTERLOCK	4.4, 5.5	STARTING USING THE TIMER	4.1
LABELS		STEPPING THROUGH	4.2
EDITING THE AUXILIARY LABELS	3.6	WHAT IS A SHOW?	1.1
EDITING THE SEGMENT LABELS	3.7	SLIDES	
LIGHTS		CONTROL SCREEN	2.3
CONTROL	2.7	PROGRAMMING	5.4
PROGRAMMING	5.15	SETTING THE NUMBER OF SLIDES	4.3
MASKING		SOUND SCREEN	2.7
CONTROL	2.5	START A SHOW USING THE TIMER	4.1
PROGRAMMING	5.15	SYSTEM SETUP	3.1
MEMORY		TRIGGERS	
DOWNLOADING	5.11	IGNORE CUES	4.2
UPLOADING	5.11	INBOARD CUE FOR LENS CHANGE	3.4
MENU SCREEN	2.8	SELECTING A TRIGGER	5.14
MONITOR		SETTING WAIT TIME	5.16
CONTROL	2.8	SKIPPING CUES IN A SHOW	4.2
SOUND LEVEL BAR GRAPH	2.9	TYPES OF TRIGGERS	5.2
SURROUND IN NON-SYNC OPTION	6.6	WHAT IS A TRIGGER?	1.1
VOLUME CONTROL	2.9	TURRET	
MUTE		DELAY TURRET ROTATION	6.7
CONTROL	2.9	OPERATING MODE	3.3, 3.4
PROGRAMMING MUTE COMMANDS	5.4	SETTING THE LENS TURRET DELAY	3.4
OPTIONS SWITCHES	6.6, 6.8	SINGLE INPUT TURRET OPTION	6.7
PROGRAMMING		TUTORIALS	
CINEMA INTERLOCK	5.5	SEGMENT PROGRAMMING	5.13
COPY AND PASTE	5.10	SHOW PROGRAMMING	5.18
MUTE COMMANDS	5.4	STORE DEFAULTS	3.9
SEGMENTS	5.1	VOLUME	
SESSIONS	5.8	MONITOR VOLUME	2.9
SHOWS	5.1, 5.6	PROGRAMMING VOLUME CHANGES	5.4
SLIDES	5.4	VOLUME/SCROLL CONTROL	2.9
VOLUME CHANGES	5.4	XENON	
WHILE A SHOW IS RUNNING	4.3	PROGRAMMING CHANGES	5.15
PROJECTOR		XENON FAULT	3.8
CONTROL	2.3	ZIPPER	3.3