

# FILM-TECH

**THE INFORMATION CONTAINED IN THIS ADOBE ACROBAT PDF FILE IS PROVIDED AT YOUR OWN RISK AND GOOD JUDGMENT.**

**THESE MANUALS ARE DESIGNED TO FACILITATE THE EXCHANGE OF INFORMATION RELATED TO CINEMA PROJECTION AND FILM HANDLING, WITH NO WARRANTIES NOR OBLIGATIONS FROM THE AUTHORS, FOR QUALIFIED FIELD SERVICE ENGINEERS.**

**IF YOU ARE NOT A QUALIFIED TECHNICIAN, PLEASE MAKE NO ADJUSTMENTS TO ANYTHING YOU MAY READ ABOUT IN THESE ADOBE MANUAL DOWNLOADS.**

**[WWW.FILM-TECH.COM](http://WWW.FILM-TECH.COM)**

## KT 2023 SYSTEMS made for GENERAL CINEMA THEATRES

These systems contain KT 1003 Processor, Digimate 1100 Quad amplifier, and KT 1035 monitor, in a KT 2020 frame. Please note a change in manufacture of the KT 1035 monitor:

Monitor Automatic Return-to-center Defeat.

To defeat the Return-to-center function turn on switch #1 section #4 which is a dip switch inside on the front panel control board. see fig. #6 in the KT 1035 section of the manual for the location. This is factory set in the off position.

### IMPORTANT NOTE:

When these systems are equipped with Kt 90 subwoofers as are these GENERAL CINEMA systems, the low frequency should be run only to the subwoofer and not also to the surround system. Dip switch #1 section #2 located on board #2 should be turned off. See page 3-5 paragraph 3.2 and figure 3.2. This switch has been factory set with both sections on.

### KT 2020 Frame:

An output is supplied on TB#1 pin #1 called Lt&Rt to supply unprocessed center to systems to aid the hearing impaired. This is a single ended output of 150 ohms impedance with 0.5 volts output at full modulation of the film. Use pin #3 of TB #1 as the ground side.

### Stereo Detector Disable.

The stereo detector only differentiates between SVA and SR decoding by manual preselection. See Chapter 3.1. If the external automation has provision for selecting SVA and SR separately, then the detector may be disabled. This may be done by setting a switch on board #3. See Figure 3.3 "Board 3 User Controls" At the mid top of board 3 is switch #5 marked "Detector Select Transfer". Switch part #2 of this switch to "off" in order to disable the detector.

## REPLACING A KT1000Z WITH A KT1003 PROCESSOR

When replacing the KT1000Z processor with a KT1003 processor the wiring is compatible except that the KT1003 is capable of stereo non/sync and therefore has a second non sync input. This leaves you with two options for the wiring.

1). To hook up to a stereo non/sync system. The current connection becomes the left input TB#1 16 and 15 become the right input. The non/sync matrix sends left plus right to the center and left minus right to the surrounds. There are adjustments of the overall non/sync level and adjustment of the surround level relationship to the center level.

Or:

2). To continue with mono non/sync with no wiring change and both center & surrounds speakers will be fed mono non/sync. The same level adjustments apply to this option also.

KT-2023 THEATRE SOUND SYSTEM

Installation and Operation

Kintek, Inc.  
224 Calvary Street  
PO Box 9143  
Waltham, MA 02254-9143  
May 10, 1989

### Warranty and Repair

Equipment manufactured by KINTEK carries a limited warranty against defects in materials and workmanship for two years from the date of purchase. Kintek will, at its option, repair or replace defective components provided the unit is shipped to Kintek or its authorized distributors with a Return Authorization Number. Defects caused by modification, misuse or other damage caused by improper packing are not covered by this limited warranty.

In the event you have a problem, call your equipment dealer and list specifically the symptoms, it will often speed up the repair.

KINTEK products are manufactured under one or more of the following US patents: 3,681,618; 3,714,462; 4,101,849; 4,097,767. Canadian patents: 4,589,129; 1,153,701.

Other patents pending.

# KT-2020 BIAMPLIFIED CENTER/SPLIT SURROUND SOUND SYSTEM

KINTEK® is proud to offer an upscaled version of its popular KT-2010 System with the KT-2020 Bi-amplified Center/Split Surround Sound System. This is the ultimate in Center/Surround Systems — making the most out of a limited number of speakers. To improve dialog articulation, the center channel utilizes an active crossover network to bi-amplify the center stage speaker. The surround information is split into left and right channels and steered to emphasize stereo film mixes played in center/surround format. The KT-2020 even comes with built in capability to decode the new Dolby® SR format.

This is a complete system designed for use in small or narrow auditoriums. The components are modular for easy installation and service. The system comes in a prewired, fully-tested 10½" high wall mount or rack-mountable frame with monitor and regulated DC exciter lamp power supply that includes automatic AC emergency backup.

Part of the reason the KT-2020 is such a cost effective system is due to our Digimate® 1100 Quad Amplifier — 4 passively cooled Digimate Power Amplifiers in a single module with more than enough power to exceed the required peak levels per channel in an auditorium of 50,000 Cubic Foot Volume.

The KT-2020's processor contains a stereo preamplifier with back-up, dynamic range expansion, SVA decoder with surround steering, active crossover, surround synthesizer for mono, as well as KINTEK®'s superior three-band deciliner noise reduction for Stereo Optical A type, SR, and mono prints. A sub harmonic synthesizer, for an extra octave of low frequency enhancement can be fed to an optional sub woofer (like our KT-90) or suitable surround speakers (like our KT-340). The processor may be operated manually, through an automation system, or by its internal detector. It automatically detects stereo optical film when it passes through the projector and will change over to SVA Process, making the appropriate level adjustment, without operator assistance. Standard A type of SR noise reduction can be preprogrammed.

The KT-2020's bi-amplified center channel improves definition and dialog articulation. The active crossover has many of the features found in the most sophisticated designs for motion picture use. It provides steep filtering (30 dB per octave) for the protection of the high frequency drivers. Phase compensation keeps high and low drivers in phase through the crossover region. Analog time delay in the low frequency filter makes the low frequency driver speak simultaneously with the high frequency horn. There is high frequency equalization for horn and screen loss and variable attenuation to compensate for differences in efficiency in the high and low frequency drivers. This flexibility assures perfect alignment for a wide variety of two way speaker systems.

The entire KT-2020 System, including the electronic crossover, is equipped with emergency back-up in the unlikely event of a failure.

The KT-2020 comes as close as possible to a full four channel system by making the most of the center and surround speakers, while still keeping the investment cost effective for the small or narrow auditorium.



- The Ultimate in Center/Surround Systems
- Built in Active Crossover
- Left/Right Surrounds
- SR Decoding Standard
- Automated Format Selection
- Sub Harmonic Synthesizer for Low Frequency Enhancement
- Synthesized Surround with Noise Reduction for Mono Films

Specifications are subject to change without notice.

"KINTEK" and "Digimate" are trademarks of KINTEK, Inc.

"Dolby" is a trademark of Dolby Laboratories Licensing Corporation.

**WARRANTY AND REPAIR:** Equipment manufactured by Kintek carries a limited warranty against defects in material and workmanship for two years from the date of purchase.

## KINTEK

KINTEK INC.  
224 Calvary Street, PO Box 9143  
Waltham, MA 02254-9143  
(617) 894-6111  
FAX (617) 647-4235

## KT-2023 SYSTEM MANUAL CONTENTS

### 1. KT-1003 FRONT PANEL

	Section
Operator Controls and Indicators	1.1
Test Connector and Calibration Controls	1.2

### 2. SYSTEM CONNECTIONS and CALIBRATION

Connections	2.1
A Chain Alignment Overview	2.2
A Chain Alignment Procedure	2.3
Biamp/Crossover Features	2.4
Biamp/Crossover Alignment Procedure	2.5
B Chain Alignment with Pink Noise Loop	2.6
B Chain Alignment with Kintek Test Card	2.7

### 3. AUTOMATION and INTERNAL CONTROLS

Automation Options	3.1
Description of Automation Set Up Switches	3.2
Internal Controls - Location and Definition	3.3

### 4. DIGIMATE 1100 POWER AMPLIFIER 4.0

### 5. KT-1045 MONITOR/EXCITER LAMP SUPPLY 5.0

### APPENDIX A KINTEK CENTER/SURROUND STEREO A1

## 1.1 KT-1003 FRONT PANEL CONTROLS AND INDICATORS

### MASTER FADER

The Master Fader controls the overall system level. Center, surround and low frequency outputs remain balanced.

The normal setting is at "7". There is 12dB of reserve gain between this point and "10".

### FORMAT SELECT

The FORMAT SELECT switch provides manual selection of MONO, STEREO or SPEC REC format processing. Push to cycle through the formats. Selection indicated by fully lit LED.

### DETECTOR SELECT

The DETECTOR SELECT switch specifies the process to be activated when a stereo print is detected. Push to cycle through MONO, STEREO or SPEC REC. Selection is indicated by an LED with reduced brightness.

### MODE

The MODE switch provides manual selection of non-sync or film sound source.

### EMERGENCY BYPASS

The EMERGENCY BYPASS substitutes a spare preamp and passive crossover connected to the center channel power amps.

### BAL and CAL

With exciter lamp on and no film in the projector, BAL and CAL indicate solar cell preamp balance and calibration.

NOTE: The FORMAT SELECT and MODE switches will be inactive if continuous contact automation is used. Momentary contact automation allows manual change of FORMAT or MODE at any time.

NOTE: There is an option that allows the automation system to select MONO, STEREO or SPEC REC via the DETECTOR SELECT circuit. Refer to Section 3.1 Automation Configuration



1.2 TEST CONNECTOR and CALIBRATION CONTROLS (Fig. 1.1)

TEST CONN:

5 LOUT: Left cell preamp. 50% mod pink noise = -12dBv.  
9 LIN: Left input to decoder matrix. 6dB attenuation.  
4 +15vdc  
8 nc  
3 ground  
7 nc  
2 -15vdc  
6 RIN: Right input to decoder matrix. 6dB attenuation  
1 ROUT: Right cell preamp. 50% mod pink noise = -12dBv

SLIT LOSS CORRECT:

Separate left and right frequency adjustable equalizers for A Chain response correction.

BYP CAL:

Level trim for emergency bypass solar cell preamp.

BAL:

Adjusts balance of left and right solar cell preamps to produce equal level from both. With exciter lamp on and no film in the projector, the BAL LED will be on.

CAL:

Adjusts gain of solar cell preamps. With exciter lamp on and no film in the projector, the CAL LED will be on.

NON SYNC LEVEL:

Separate trim control for front and surround non-sync levels.

CTR EQ:

LOW, MID and HIGH boost/cut trims for center B Chain EQ.

FUTURE CTR HF:

Adjusts center high freq EQ for future formats.

1.2 CALIBRATION CONTROLS CONTINUED:

MONO CTR HF:

Adjusts center high freq EQ of mono films played in SYN.

SURR EQ:

Low, Mid and High boost/cut trims for surround B Chain EQ.

FUTURE SURR HF:

Adjusts surround high freq EQ for future formats.

MONO SURR HF:

Adjusts surround high freq EQ of mono films played in SYN.

SURR MONO:

Adjusts level of surround system in SYN format.

SURR SVA:

Adjusts level of surround system in SVA or SR formats.

CTR MONO:

Adjusts level of center loudspeaker in SYN format.

CTR SVA:

Adjusts level of center loudspeaker in SVA or SR formats.

LF MONO:

Adjusts level sent to subwoofer amplifier in SYN format.

LF SVA:

Adjusts level sent to subwoofer amplifier in SVA or SR format

L/R SVA : not used in KT-1003

TEST  
CONN

LOUT  
LN  
+15V  
NC  
GND  
NC  
-15V  
LN  
ROUT

SLIT R  
LOSS  
CORRECT L

BYP  
CAL

BAL

CAL

NON FRONT  
SYNC  
LEVEL SURR

LOW CTR SURR  
EQ MONO  
MID EQ SURR  
SURR  
HIGH SURR

FUTURE CTR  
CTR HF MONO  
MONO CTR  
CTR HF SURR

LOW SURR LF  
EQ MONO  
MID EQ SURR  
HIGH LF  
SURR

FUTURE  
SURR L/R  
MONO SURR SURR  
HF SURR

# KINTEK KT-1003 THEATRE SOUND PROCESSOR

BAL ●  
CAL ●

NON-SYNC ●  
FILM ●

MODE 

EMERG.  
BYPASS 

5 6  
4 7  
3 8  
2 9  
1 10  
MASTER FADER 

DETECTOR  
SELECT 

MONO ● SYN  
STEREO ● SVA  
SPEC REC ● SR

FORMAT  
SELECT 

Figure 1.1 KT-1003 Front Panel

## SECTION 2      SYSTEM CONNECTIONS AND CALIBRATION

### 2.1 CONNECTIONS      Refer to fig. 2.1

Note: On a rack mount unit, TB1 is found on the back of the main frame on the right side. TB2 is on the left side. On a wall mount unit, TB1 is near the top of the rear panel and TB2 is near the bottom.

CENTER LOUDSPEAKER HIGH FREQUENCY DRIVER: TB2 #1(+), #2(-)

CENTER LOUDSPEAKER LOW FREQUENCY DRIVER: TB2 #3(+), #4(-)

LEFT SURROUND LOUDSPEAKERS: TB2 #5(+), TB2 #6(-)

RIGHT SURROUND LOUDSPEAKERS: TB2 #7(+), TB2 #8(-)

Note: Connect the surrounds in phase and be sure the final load impedance is not less than 4 Ohms. Kintek KT-340 Surround Loudspeakers are 24 Ohms each, a set of four may be connected in parallel.

SUBWOOFER AMPLIFIER: TB2 #9-#11.

Note: Single ended inputs should be connected to #9(+) and #11(ground). For differential inputs, (KT-90) connect to #9(+), #10(-) and #11(ground).

REMOTE FADER:(Optional) TB2 #12(Top), #13(Wiper), #14(Bottom)

Note: Use the Kintek KT-1047 calibrated remote box or a 20k Ohm linear pot. +/-6dB available. Use 3 wire shielded cable, ground shield at frame end only.

EXCITER LAMP: TB2 #15(+) and #16(-)

EXTERNAL AUDIO: TB2 #17(+) and #18(-)

This is a balanced and floating input provided for public address announcements. The source may be single ended or balanced but must provide a ground reference, it can not be floating. When enabled by TB1 #2 (ext audio on), a line level signal at TB2 #17 is sent to the center amps and loudspeaker via the passive crossover. Normal operation is interrupted.

2.1 SYSTEM CONNECTIONS CONTINUED:

NON-SYNC INPUTS:

Right: TB1 #15(-), #16(+) Left: #17(-), #18(+)

Note: Refer to fig 2.2 for various connection options

SOLAR CELL: TB1 #11(Grnd), #12(Return), #13(Right), #14(Left)

AUTOMATION: TB1 #2 - #10

Note: Refer to Section 3 AUTOMATION CONFIGURATION

# System Connections

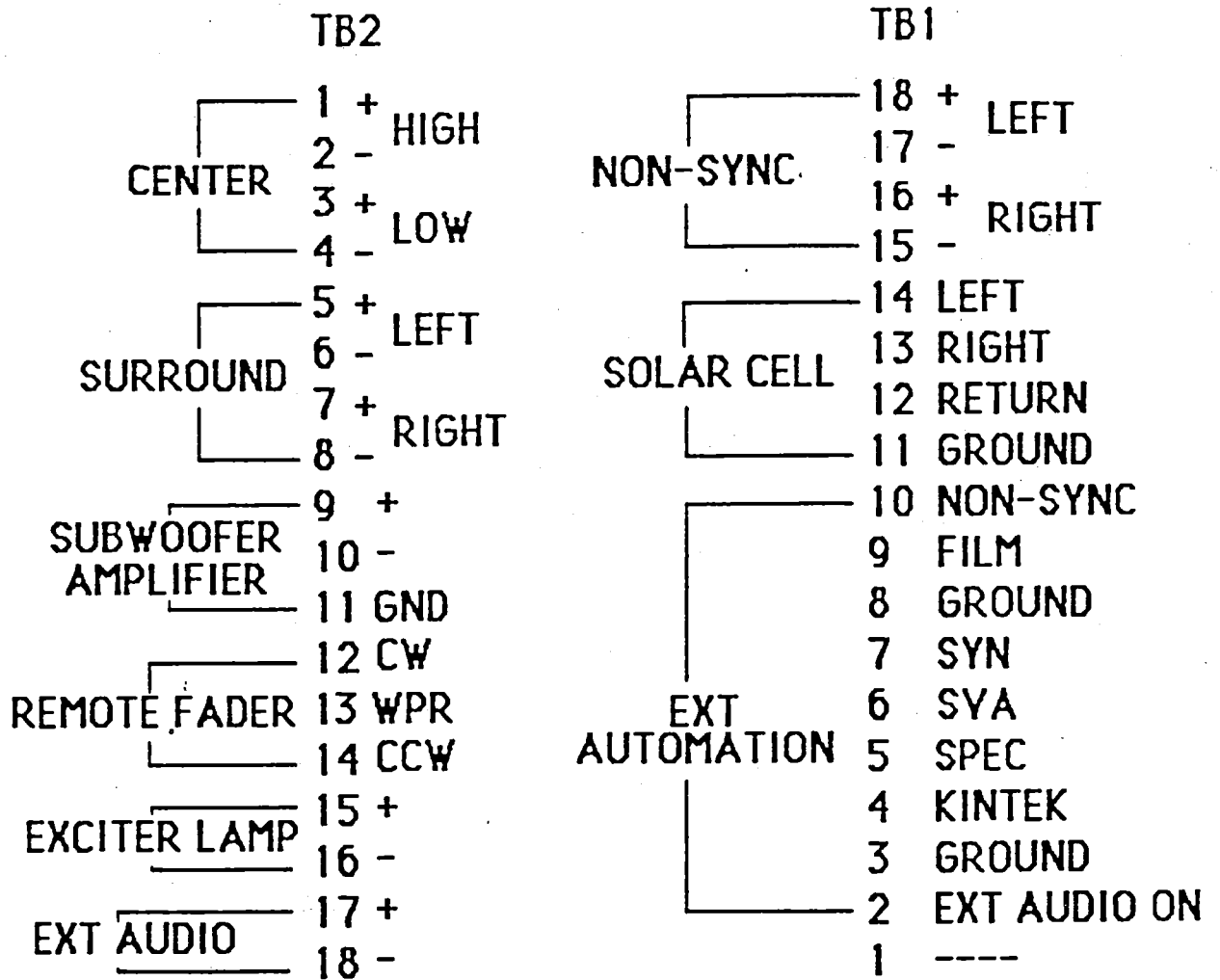

## NOTES

1. **Non-Sync:** Connect audio cable shield at source ground only.  
Connect mono program sources to right input only.  
Single ended sources: run a balanced line to the source and tie (-) to ground.
  
2. **Solar Cell:** Individual audio lines for left and right cells are recommended.  
Connect solar cell cable shields at TB1 only. Do not connect at projector end.  
Color code: Left=red Right=green Return=black

Figure 2.1 System Connections

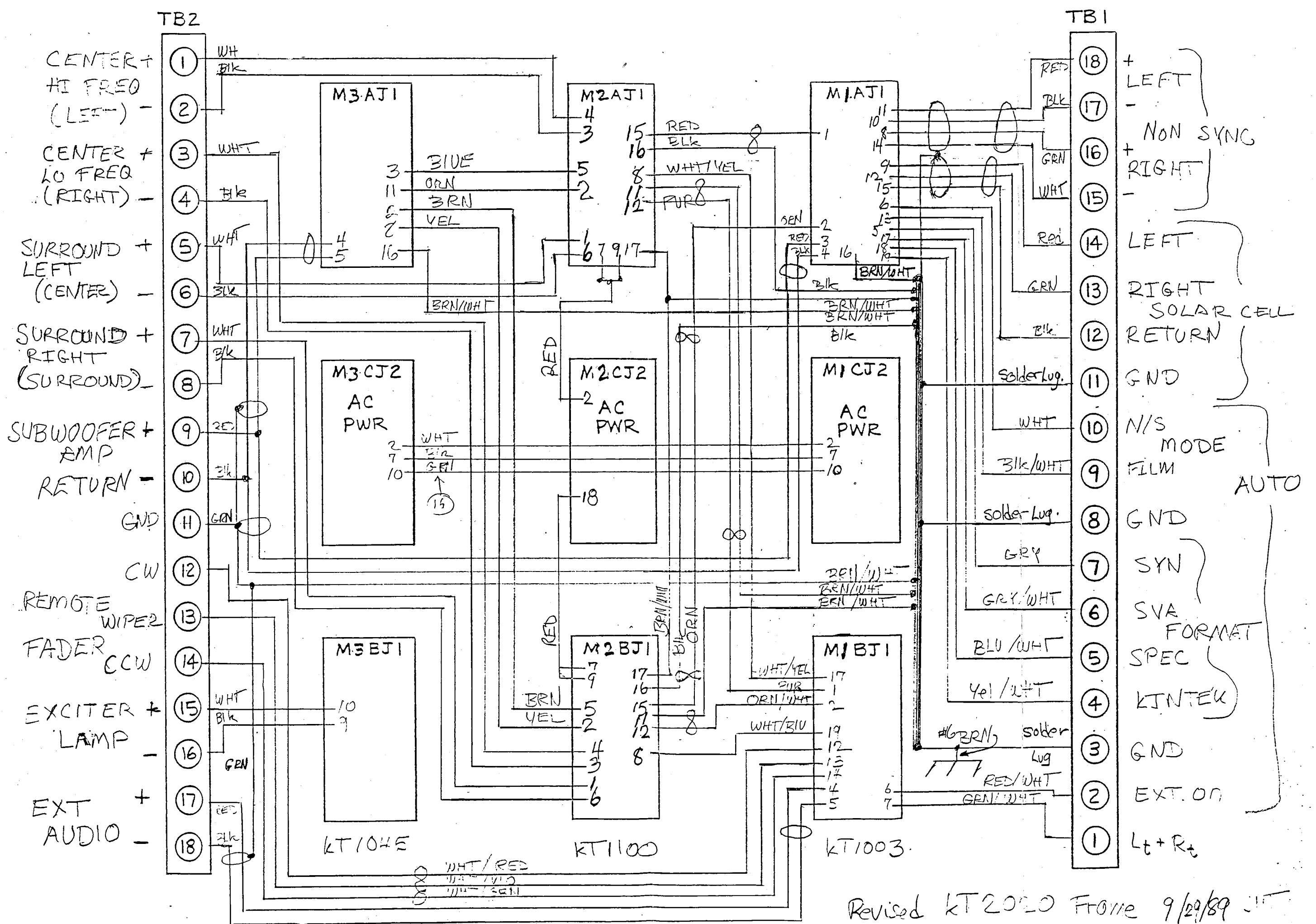

## 2.2 A CHAIN ALIGNMENT SUMMARY

The A Chain Alignment involves setting the position of the exciter lamp, slit optics, film path and solar cell to give the desired response at the preamp output.

The center of the evenly illuminated slit should line up with the center of the film soundtrack, then be projected onto the center of the solar cell.

Standardized test films are run through the projector and monitored at the output of the preamplifier. The Buzz track test film is used to set the slit to soundtrack position. The left/right test film is used to set the solar cell position for optimum balance and channel separation. The Pink Noise test film is used adjust slit optics for optimum frequency response and azimuth. Stereo film playback requires the use of 1 mil or narrower slit optics.

In addition, the Kintek solar cell preamplifier balance indicator is used to initially set exciter lamp and solar cell position.

In most projectors these adjustments will interact with one another, so it is necessary to recheck the adjustments made previously.

## 2.3 A CHAIN ALIGNMENT PROCEDURE (Refer to Fig 2.2 and 2.3)

Set the exciter lamp voltage to 80% of the lamps rating. This will prolong usefulness and minimize filament sag. The trim adjustment is found at the back of the KT-1045 module behind the barrier strip. (For additional information, see Chapter 5, KT-1045 Monitor/Exciter Supply)

Make sure the slit optics are clean and not fogged. Install the slit optics and turn on the exciter lamp. View the projected slit image by holding a piece of white paper just beyond the film plane. Focus the filament and see that it is centered horizontally and vertically, adjust the exciter lamp mount if necessary.

Clean and inspect the solar cell for cracks or breaks, a damaged cell will not calibrate. Put the solar cell bracket in place. Adjust the bracket until the surface of the cell is 1mm from the film plane surface. Left/right crosstalk will result if the cell further away.

Check the image of the slit on the cell. The image should be a thin sharp line centered on, and nearly as wide as the cell. The image should be positioned at 3/4 of the height of the cell. Try to get the best compromise among all of these conditions and then tighten the cell bracket.



### 2.3 A CHAIN ALIGNMENT PROCEDURE CONTINUED:

Set the Bal pot on the KT-1003 to the physical center of its rotation. Turn on the power, select film mode and adjust the Cal pot until the Cal LED is lit. Loosen the cell bracket and move the cell laterally until the Bal LED is lit, then re-tighten the cell bracket. Re-adjust the Bal pot to light the Bal LED if necessary. Try to achieve a balance indication with the pot near the center of its rotation.

Connect a dual trace scope to the left and right preamp test points. (L OUT and R OUT of the test connector) Run the SMPTE Buzz Track and adjust the lateral guide roller until a minimum or no modulation is detected from either scope trace. If some modulation is observed, the amplitude of both sides should be equal. This assures that the slit is illuminating only the track area and is centered on the track.

Connect the spectrum analyzer to one of the preamplifier output channels. Place a loop of pink noise film in the projector, be sure the emulsion is facing away from the screen as it runs through the projector. Loosen the clamp and adjust the slit lens position to obtain maximum high frequency output. Set the scope to x/y mode and adjust the slit to obtain the best azimuth indication. Tighten the clamp only enough to hold the slit lens in place, over tightening will distort the lens elements.

Remove the pink noise film and replace it with the left/right test film. Set the scope to dual trace mode and run the film. Loosen the cell bracket and adjust its lateral position for a minimum of cross talk, and for an equal amplitude of signal in both tracks. Check to see if the left and right cell are properly connected to their left and right preamplifiers by inserting a business card in front of the slit lens. The right channel should drop first.

Remove the left/right film from the projector. With the slit illuminating the solar cell, re-trim the preamp calibration and balance. The balance should be near the center of its rotation.

Lace up and roll the pink noise loop. Adjust the slit loss EQ pot for the most flat line possible to 12.5kHz. Repeat for the second channel. Take care not to introduce high frequency phase shift between left and right channels while adjusting the second channel eq pot. The scope x/y trace should still show a narrow azimuth indication. If the pot position required for each side is very different, inspect the slit lens for oil or dirt. A defective exciter lamp could also cause left/right high frequency imbalance.

This completes the A chain adjustment procedure.

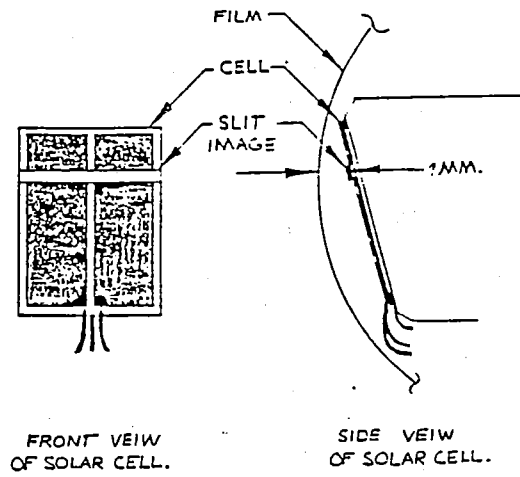

Figure 2.2a Solar Cell Position

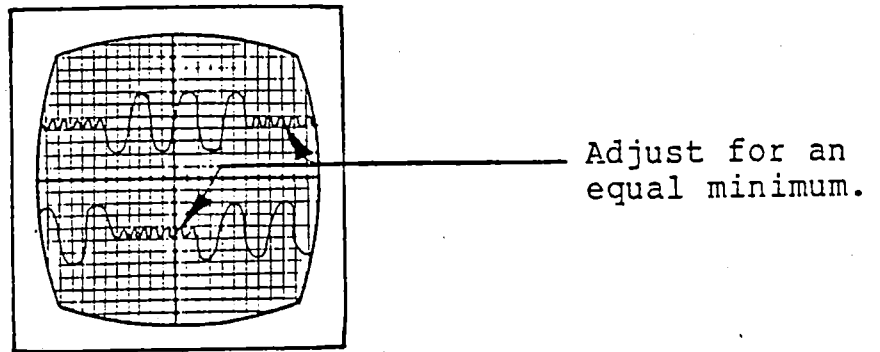

Figure 2.2b Left/Right Film on Dual Trace Scope

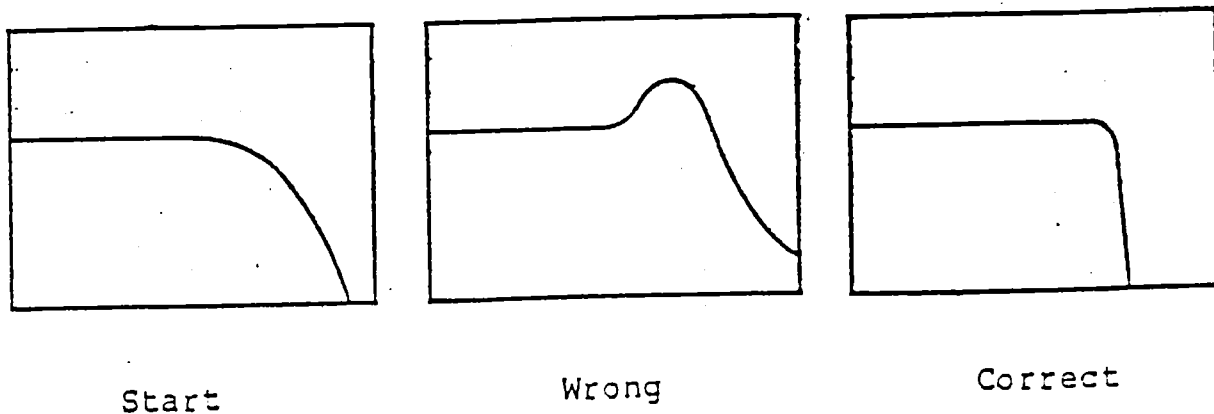
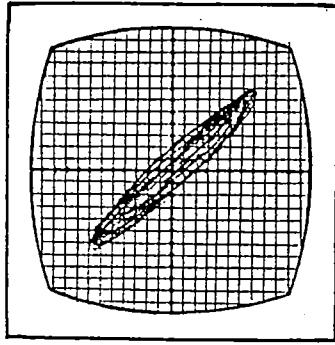
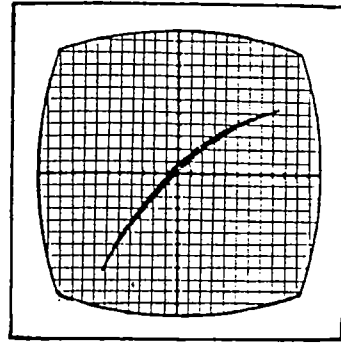

Figure 2.2c Slit Loss EQ Adjustment on Spectrum Analyzer



Azimuth Out  
Of Adjustment.



Uneven Light  
Both Channels.

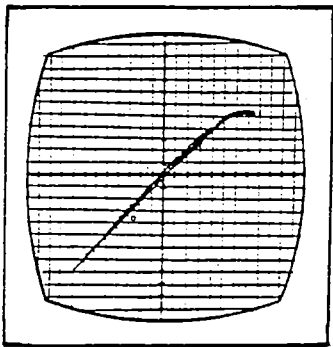

Uneven Light  
One Channel.

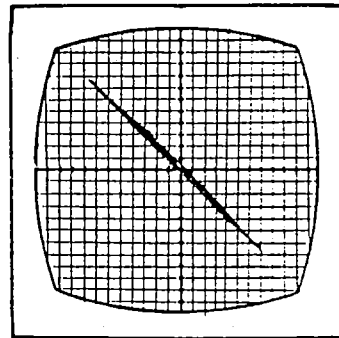

One Channel  
Phase Reversed.

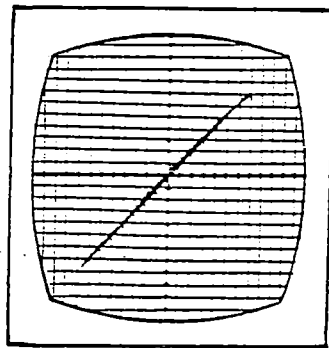

Correct

Figure 2.3 Pink Noise Film on X/Y Scope

REAR PANEL

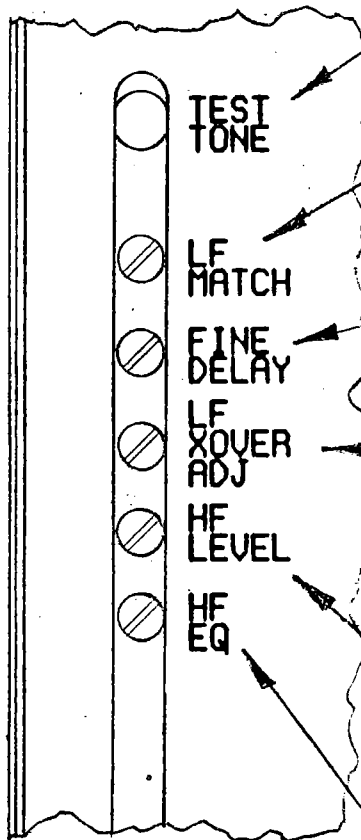

**TEST TONE:** push to activate test tone for adjusting time delay.

**LOW FREQUENCY MATCH:** adjusts for unity gain from input to output through low frequency filter. Range 1 dB. Factory set.

**FINE DELAY ADJUST:** adjusts delay over a .3 ms range.

**LOW FREQUENCY CROSSOVER ADJUST:** moves the low pass filter frequency slightly. This can be used after other adjustments completed, to correct a peak or null right at the 500 Hz crossover frequency. This is factory set at the center of the pot. Make sure that is in the center before starting the adjustment procedure.

**HIGH FREQUENCY LEVEL:** sets level compensation for the difference in efficiency between woofer and horn. This continuously variable control attenuates 0 dB min. to 15 dB max.

**HIGH FREQUENCY EQUALIZATION:** hinged at 4kHz, varies from +3 to +14 dB at 12 kHz to compensate for high frequency loss in the horn.

SIDE PANEL

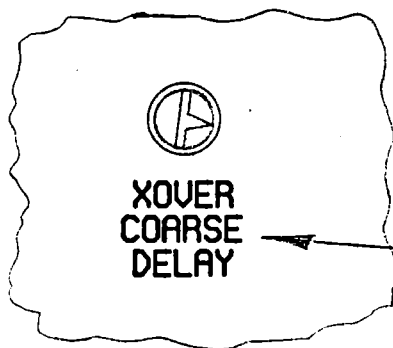

**COURSE DELAY ADJUST:** 5 position switch .7 to 1.0 ms, 1.0 to 1.3 ms, 1.3 to 1.6 ms, 1.6 to 1.9 ms, 1.9 to 2.2 ms. Reach switch through right side panel.

Figure 2.4 Biamp/Crossover Adjustments

## 2.4 BIAMP CROSSOVER FEATURES

The crossover, which uses modified Bessel criteria, protects the driver by providing 30 dB of attenuation at the resonant frequency. The circuit keeps high and low frequency drivers in phase through the crossover region. Time delay in the low frequency filter makes the low freq driver speak simultaneously with the high freq horn, which has a longer air path. The delay is adjustable from .7ms to 2.2ms.

There is 5 to 15 dB of adjustable high freq attenuation to compensate for differences in efficiency between high and low freq drivers. The crossover includes a high frequency equalizer to compensate for losses in the horn/driver.

The low freq output section has a +/- 1dB level adjustment. Noise is -90dBv unweighted with THD of .08% at 1 volt rms. Maximum input level before clipping is +18dBv, more than 10 dB higher than the level required to drive the power amp to full output. The differential input circuit offers 40 dB of common mode rejection. A 30Hz high pass filter protects the Woofers against excessive drive at low freq.

Antithump power up circuits protect the drivers and provide quiet start up conditions. An emergency bypass provides a passive crossover in the event of failure.

## 2.5 BIAMP/CROSSOVER ALIGNMENT PROCEDURE (see figure 2.4)

The controls used to adjust the biamp/crossover are located at the back of the KT-1003 module and can be reach through the back of the frame.

Place a sound level meter on a line perpendicular to the faces of the speakers. It should be equidistant from the high frequency horn and the nearest low freq driver. Make sure the low freq crossover adjust is set in mid position. Next turn on the internal oscillator. Turn on the low freq amp and measure the SPL. Turn off the low freq amp.

Turn on the high freq amp and set the HF LEVEL trim to produce the same SPL as the low freq loudspeaker. Reverse the polarity of the high freq driver and turn on both amplifiers. Adjust the FINE DELAY control until a SPL null is observed. If a null can not be set, change the coarse delay setting. The depth of the null will be affected by room reflections and high freq driver level.

Return the high freq driver to normal polarity and turn off the internal oscillator. With a pink noise source on (either pink noise on calibrated A chain or Kintek Test Card) adjust HF LEVEL and HF EQ for the desired frequency response.

END OF BIAMP/CROSSOVER ALIGNMENT

## 2.6 B CHAIN ALIGNMENT WITH PINK NOISE FILM

Note: The SPL readings to follow are meant to be used as a guide. Ultimate level settings should be determined by evaluating film program. In SVA format, there should be a noticeable separation between the center and surround channels. The surround channel should not dominate the center channel. In SYN format, dialog crosstalk should not be audible in the surrounds. Loud sustained sounds should project clearly from the surrounds.

The following section describes a B Chain alignment procedure using a loop of pink noise film running through the projector. If you have been supplied with a Kintek Test Card refer to Section 2.7

Lace up and roll the pink noise loop. (Make sure the emulsion side of the loop is facing away from the screen as it runs through the projector.) Set the master fader to 7. If used, set the remote fader to the mid point. Put the processor in the SVA format by pushing the front panel FORMAT SELECT button. Turn on the center channel power amplifiers by sliding the mute switches up. Adjust the CTR SVA level trim control to produce a SPL of 80dBc slow in the center of the room.

Using a spectrum analyzer connected to a calibrated mic in the auditorium, adjust the CTR EQ trims (LOW MID HIGH) to achieve a flat response to 2kHz with a roll off of 3dB/octave above 2kHz. MUTE the center channel amplifiers.

At TB1 # 4, remove the right channel solar cell line. This will allow the mono pink noise to be fed to the surrounds for level setting. Do not re-calibrate or balance the preamp. Turn on the surround left power amplifier and adjust the SURR SVA level trim to produce a SPL of 84dBc slow in the center of the room. MUTE the surround left amplifier and re-connect the right solar cell line.

Change the processor to SYN format and turn on the center channel power amplifiers. Adjust the CTR MONO level trim to produce a SPL of 74 dBc slow in the center of the room.

Using the spectrum analyzer, adjust the MONO CTR HF trim to produce a HF response that is flat to 2kHz and rolls off 5-6dB/octave to 8kHz. This is an approximation and should be checked later by auditioning a mono film. MUTE the center channel power amps.

## 2.6 B CHAIN ALIGNMENT CONTINUED:

Turn on both surround amplifiers and adjust the SURR MONO level trim to produce a level of 68 dBc slow in the center of the auditorium. Using the spectrum analyzer and auditorium mic, adjust the SURR EQ trims (LOW MID HIGH) to achieve a response flat to 2Khz with a roll off of 3dB/octave above 2kHz. MUTE the surround amplifiers.

Connect the subwoofer system to TB2 terminals #9 -# 11. In the SYN format, adjust the LF MONO trim to produce a level of 70 dBc slow in the center of the auditorium. In the SVA format, Adjust the LF SVA trim to produce a level of 75 dBc slow in the center of the auditorium.

Note: For the remaining steps, leave the pink noise running and lower the master fader to 6.

Turn off the subwoofer and surround amplifiers. Place the processor in the SYN format, turn on the Center amplifiers and roll the pink noise loop. Make note of the SPL in the auditorium. Push the EMERGENCY BYPASS button and adjust the BYP CAL trim to produce the same SPL.

In the emergency bypass mode, a spare solar cell preamp and passive crdssover are switched in. The passive crossover has a high freq level adjust that can be adjusted. This trim pot is located on board #3 at the lower edge.

### Surround Delay Setting:

The surround delay pot is located on board #1 at the top front edge. The delay is adjustable from 25ms at full CCW through 60ms at mid rotation to 90ms at full CW. The delay setting is determined by measuring the distance in feet from the screen to a seat in the last row close to a surround speaker. From this seat, measure the distance to the nearby surround speaker and subtract this number from the first measurement. Then add 20 to this result to arrive at the time delay in milliseconds to be set.

Remove the left solar cell lead from TB1. Place the processor in SVA format. Turn on the Surround amplifiers. Roll pink noise and note the SPL. Turn on the Center amplifiers. Lower the SURR SVA trim to min.

Run a passage of either stereo or mono film containing dialog. Listen for dialog to arrive from the center channel first without a noticeable echo in the surrounds. Walk around the room to determine that the surround delay setting is the best average for the entire seating area.

## 2.6 B CHAIN ALIGNMENT CONTINUED:

It may be necessary to adjust the SURR SVA trim to balance the dialog heard in the surrounds with that heard from the center. Turn off the Center channel amplifier. Re-connect the left solar cell lead and readjust the SURR SVA trim to produce the level noted above.

## 2.7 B CHAIN ALIGNMENT USING KINTEK TEST CARD

The test card can be used as a noise source for the B Chain alignment. It supplies pink noise at the same level as the pink noise loop for center channel. Additionally the card can supply pink noise for setting the surround level in SVA Format.

Plug the test card into the nine pin sub D socket at the front right hand corner of the processor. When all the switches are depressed no noise is sent to processor. In this mode, readings of the preamp output can be made at the three test points at the base of the test card. To make a surround signal, all three switches are in the out position. To make center, switch 1 + 3 are out and the center switch #2 is depressed. Do not run the projector at the same time as the signals will be mixed.

To set level and eq. of center channel set switches to make center (1, off; 2, in; 3, out.) Set the master fader to 7. If used, set the remote fader to the mid point. Put the processor in the SVA format by pushing the front panel FORMAT SELECT button. Turn on the power amplifiers by sliding the mute switches up. Adjust the CTR SVA level trim control to produce a SPL of 80dBc slow in the center of the room.

Using a spectrum analyzer connected to a calibrated mic in the auditorium, adjust the CTR EQ trims (LOW MID HIGH) to achieve a flat response to 2kHz with a roll off of 3dB/octave above 2kHz.

Change the processor to SYN format and mute both surround amplifiers. Adjust the CTR MONO level trim to produce a SPL of 72 dBc slow in the center of the room.

Using the spectrum analyzer, adjust the MONO CTR HF trim to produce a HF response that is flat to 2kHz and rolls off 5-6dB/octave to 8kHz. This is an approximation and should be checked later by auditioning a mono film.

To set level and eq of surrounds.

Mute center channel amps. Turn on both surround amps. with format in SYN and still sending center channel from test card.



## 2.7 B CHAIN ALIGNMENT USING KINTEK TEST CARD CONTINUED:

Adjust the SURR MONO level trim to produce a level of 68 dBc slow in the center of the auditorium. Using the spectrum analyzer and auditorium mic, adjust the SURR EQ trims (LOW MID HIGH) to achieve a response flat to 2kHz with a roll off of 3dB/octave above 2kHz.

Change the Format to SVA and Turn the center switch off on the Test card (all 3 switches should be off) this produces surround signal. Adjust the SURR SVA level to produce an SPL of 80dBc slow in the center of the room.

### To set subwoofer levels.

Mute center and surround Amps - push center button in on Test card (Switches 1 + 3 out).

Connect the subwoofer system to TB2 terminals #9 -# 11. In the SYN format, adjust the LF MONO trim to produce a level of 70dBc slow in the center of the auditorium. In the SVA format, Adjust the LF SVA trim to produce a level of 75 dBc slow in the center of the auditorium.

To set Emergency level this must still be done using pink noise loop because it is a combination of A + B chain alignment. Push on all 3 switches on Test card or remove it. With pink noise loop running and master set at "6".

Turn off the subwoofer and surround amplifiers. Place the processor in the SYN format, turn on the Center amplifiers and roll the pink noise loop. Make note of the SPL in the auditorium. Push the EMERGENCY BYPASS button and adjust the BYP CAL trim to produce the same SPL.

In the emergency bypass mode, a spare solar cell preamp and passive crossover are switched in. The passive crossover has a high frequency level adjust that can be adjusted. This trim pot is located on board #3 at the lower edge.

The truth table of the switches on the test card is as follows.

Left Switch 1	Center Switch 2	Right Switch 3	Function
in	in	in	off
out	in	out	center
in	in	out	left
out	in	in	right
out	out	out	surround

## SECTION 3      AUTOMATION AND INTERNAL CONTROLS

Note:

The circuit boards in the KT-1003 module will be referred to as boards 1 - 4. When the module is viewed from the front, board number 1 is on the left side of the unit. The module must be removed from the frame to view and adjust the internal controls. In all cases, the dip switches are closed (on) when the slider is up. The processor has been designed to work with either momentary (pulsed) or continuous (latched) external automation contacts that can supply a dry switch closure to ground.

The external automation connections are made at TB1 #2 through #10. (Refer to figure 2.1)

There are several internal dip switches on boards 1 and 3 that set the automation options. (Figures 3.1 and 3.3)

### 3.1      AUTOMATION OPTIONS

#### EXTERNAL AUTOMATION WITH CONTACTS FOR EACH MODE AND FORMAT:

The processor is set at the factory to accept this type of automation. Either pulsed or latched contacts may be used. The user must supply an automation contact for the following selections: Non-Sync, SYN, SVA and SR. The external automation system must be programmed to send the correct pulse at the proper time. The processor will reset to SYN when NON-SYNC is commanded.

#### EXTERNAL AUTOMATION WITH SVA AND NON-SYNC CONTACTS:

An external automation SVA contact can be used to activate a film format that has been preset by the Detector Select switch. The most likely use of this option would be to select SR with an SVA pulse.

To enable this option, find S5 on board 3 (Figure 3.3) close #3 and open #4. Closed is toward the top of the unit. External automation contact is connected at TB1 #6, SVA.

The format will be reset to SYN when NON-SYNC is commanded.

#### EXTERNAL AUTOMATION WITH A SINGLE CONTACT (FACTORY SETTING)

This option provides a high degree of automation from a single dry contact closure to ground.

### 3.1 AUTOMATION OPTIONS CONTINUED:

#### FACTORY SETTING OF AUTOMATION OPTIONS:

When TB1 #10 (Non-Sync) is closed to ground, NON-SYNC is selected. When this terminal is floating, FILM is selected.

Additionally, the film format will automatically be reset to SYN when NON-SYNC is commanded. The processor is ready to synthesize mono trailers at the beginning of the show.

The film format is controlled by the front panel manual FORMAT SELECT button or the DETECTOR SELECT CIRCUIT.

NOTE: THE FILM/NON-SYNC BUTTON IS INACTIVE WITH THIS OPTION.

### 3.2 DESCRIPTION OF AUTOMATION OPTION SWITCHES

Board #1: Refer to figure 3.1

S4 #1 through #3 - Located near the power supply heat sinks at the top of the circuit board. #1 is toward front panel.

#1 through #3 Open: Sets up the KT-1003 circuitry to work with momentary contact external automation systems that can supply a closure to ground for each mode and format desired. Connect at TB1 #4 through #10.

#1 Closed: This resets the format to SYN when NON-SYNC is commanded. This is true for both manual and external automation command of NON-SYNC. The processor will stereo synthesize mono trailers at the beginning of a show, then switch to a stereo format if commanded by the STEREO DETECTOR circuit, front panel FORMAT or external automation. Use this configuration when a separate automation contact for SYN is not available.

#2 Closed: Any film format momentary contact external automation at TB1 #4 through #7 will simultaneously change from NON-SYNC to FILM mode and select processing FORMAT. This eliminates the necessity of a separate contact to switch non-sync mode to film mode.

#3 Closed: This allows a single continuous contact at TB1-10 to select NON-SYNC (grounded) or FILM (open) MODE.

NOTE: The only allowed combination of closed switches is #1 and #3.

### 3.2 AUTOMATION SWITCH DESCRIPTION CONTINUED:

#### Board 3: Refer to Fig. 3.3

S5 #3 and #4: S5 is located near the top center of the circuit board.

When #3 is open and #4 is closed, TB1 #2 through #10 can be used as indicated. This is the factory setting.

When #3 is closed and #4 is open, grounding the EXT SVA command terminal (TB1 #6) selects the processing format that has been preset by DETECTOR SELECT. For example, this option will allow an automation system that has only an SVA format contact to command SR format.

### 3.3 Additional Internal Controls - Location and Definition

#### 3.3.1 Board 1: Refer to Figure 3.1

SURROUND DELAY trim control:

This control is located at the top front edge of the circuit board. It is accessible from the top of the module. The delay range is adjustable from 25ms at full CCW through 60ms at mid rotation to 90ms at full CW. The control is set for 60ms at the factory.

The delay setting is determined by measuring the distance in feet from the screen to a seat in the last row close to a surround speaker. From this seat, measure the distance to the nearby surround speaker and subtract it from the first measurement. To this number add 20, the result is the time delay in milliseconds to be set.

S5 NON-SYNC STEREO/MONO:

Located next to S4 near the power supply heat sinks. When both switches are down, a left/right stereo non-sync source will play through the Center and Surround channels. The left and right non-sync channels are summed together and reproduced through the Center channel. The difference of the left and right channels (l-r) is reproduced through the surround channel. This matrixed arrangement produces a spacious front/back non-sync sound field.

Two options exist for mono non-sync playback. 1: Mono playback of non-sync source through Center channel only. 2: Mono playback of non-sync source through both Center and Surround channels. For Center only mono non-sync, close both switches (up). For Center and Surround mono non-sync, leave both switches open (down).

### 3.3 INTERNAL CONTROLS CONTINUED:

#### Notes:

1. Connect the non-sync source only to the left input for mono operation. Refer to figure 2.1.2 for non-sync wiring.
2. Balanced or single ended non-sync sources may be used. four wire and shield or three wire and shield distribution may be used. Refer to figure 2.1.2 for non-sync wiring.

#### 3.2.2 Board 2: Refer to Fig. 3.2

#### SUBHARMONIC LEVEL trim controls.

These two trim pots are visible when the module is inverted and viewed from the bottom. They are near the rear edge of the circuit board, midway between top and bottom. Clockwise rotation, when viewed from the bottom, increases subharmonic level.

The trim closer to the front panel sets the level of the subharmonic synthesized signal sent to the LF output. (TB2 #9-#11)

The trim closer to the back panel sets the level of the subharmonic synthesized signal sent to the surround loudspeaker system.

The recommended setting for both controls is 1/3 up from CCW.

S1 #1 and #2:

#### SURROUND SYSTEM OPTIONS:

Viewed from the bottom of the module, S1 is located close to the edge facing the installer, about 2/3 of the way towards the back panel. #1 is toward the back panel. #2 is toward the front panel.

#### Switch #1: Surround Channel Low Frequency Equalization:

When closed, the following eq is applied to the surround channel: +3dB @ 63Hz, +6dB @ 50Hz and +9dB @ 40Hz. This option, used in conjunction with the Kintek KT-340 surround loudspeakers, results in a surround system with low frequency response flat to 63Hz with 40Hz down only 4dB.

If loudspeakers other than KT-340 are used, audition the surround channel separately to determine power handling capability with the LF Eq option.

### 3.4 INTERNAL CONTROLS CONTINUED:

#### Switch #2: L+R Low Freq and Subharmonic Addition:

When closed, this switch adds a subharmonic synthesized signal to the surround system and adds low freq left plus right information to the surrounds. If loudspeakers other than KT-340 are used, audition the surround channel separately to determine power handling capability with this option.

The processor is shipped with both options enabled.

R129  
  
 SURROUND DELAY  
 ADJUST

AUTOMATION  
 CONFIGURATION

NON-SYNC  
 CONFIGURATION

S4 S5

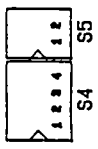

MONO/STEREO  
 CELL

S3



J1

1
2
3
4
5
6

J2

1
2
3
4
5
6
7
8
9
10
11
12

J3

1
2
3
4
5
6
7
8
9
10
11
12

J4

1
2
3
4
5
6
7
8
9
10
11
12

J5

1
2
3
4
5
6

Figure 3.1 Board 1 User Controls

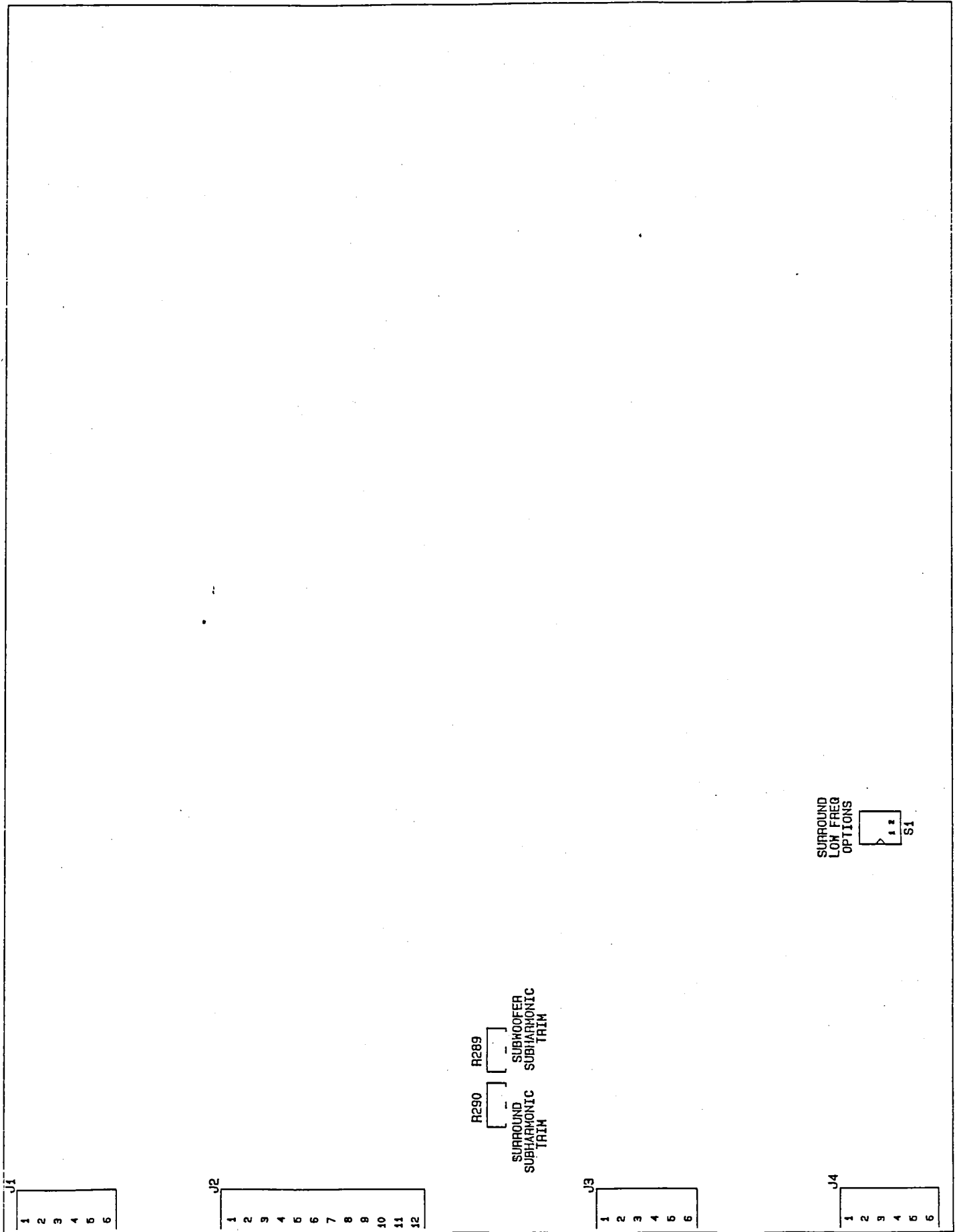

Figure 3.2 Board 2 User Controls



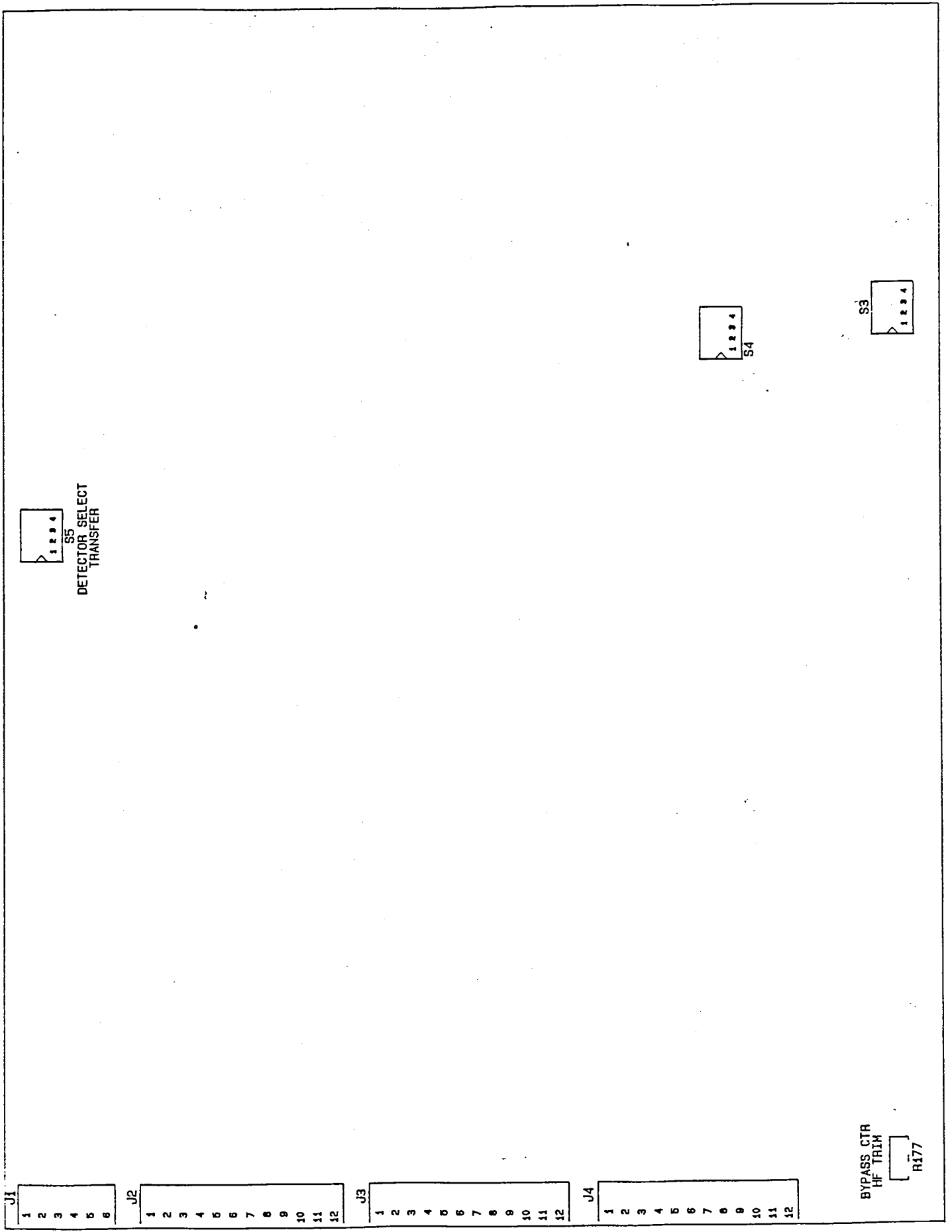

Figure 3.3 Board 3 User Controls

POWER AMPLIFIER ASSIGNMENTS IN THE KT-2020 SYSTEM

AMP #1      LEFT SURROUND  
AMP #2      CENTER HIGH FREQUENCY  
AMP #3      RIGHT SURROUND  
AMP #4      CENTER LOW FREQUENCY

# DIGIMATE 1100 AMPLIFIER

- **TOTALLY VERSATILE.**
- **SIGNALGARD CIRCUIT PROTECTION.**
- **STATE-OF-THE-ART THERMAL DESIGN.**
- **CLEAN, QUIET OPERATION.**
- **START-UP SPEAKER PROTECTION.**
- **QUALIFIED FOR MAJOR MOTION PICTURE USE.**

The Digimate 1100 is a versatile four channel modular amplifier designed to fill the needs of a wide variety of theatres. Each 1100 amplifier module can be configured as four 75 Watt per channel amplifiers, two 220 Watt per channel bridged amplifiers or a combination of both. The dedicated Digimate 1100 frame can be fitted for as many as three 1100 modules, making twelve power amplifier channels available for large scale, multi-channel sound systems; yet it is also perfect for use in Center/Surround Sound Systems. Electronic flexibility and modular expansion capability gives the theater designer maximum performance in the least amount of booth space, whether the theatre is large or small.

The Digimate 1100 quad amplifier output circuitry is similar to that used in the successful Digimate® 1010 and 1110; it gives them the reputation of being "bulletproof." It's possible to over-drive the amplifier without destroying the output stage because of its built-in Signalgard circuit. Signalgard is an internal system monitor which assures the power stages of always being well within their Safe Operating Area (SOA). But even more important to the theatre's patrons,



Signalgard never shuts the Digimate 1100 down, even when over-driven for long periods. Signalgard will always keep the 1100 amplifier operating within its SOA. A comprehensive set of LED indicators on the amplifier's front panel indicate power on, limiting and mute for each of the channels.

One of Signalgard's unique characteristics is its ability to maintain high average output levels without audio clipping. Its internal circuits continuously monitor signal conditions and momentarily reduce the gain when an excessive signal condition is anticipated. This signal conditioning is performed free of any audible distortion; it adds about 12 dB of compressed, distortion-free guard band level before clipping during occasional periods when the amplifier is overdriven.

## KINTEK

KINTEK, INC., 224 Calvary St., PO Box 9143, Waltham, MA 02154-9143 (617) 894-6111

The 1100's versatility to accepting various load impedances is a valuable feature. When operated as four single channel amplifiers, each amplifier can drive 8 Ohm loudspeakers to 75 Watts. The same amplifier can drive 4 Ohm loudspeakers to 110 Watts per channel. When the amplifier is loaded with 4 Ohm loudspeakers, a very demanding condition for any amplifier, Signalgard will manage the internal circuit conditions to prevent signal clipping and internal amplifier destruction; under these conditions the amplifier can be over-driven by up to 12 dB before clipping occurs.



KINTEK, INC.  
224 Calvary St.  
PO Box 9143  
Waltham, MA 02154-9143  
(617) 894-6111

The differential input circuit is fully balanced to ground; it minimizes common mode noise and eliminates ground loops. AC coupling is used in the amplifier, eliminating the need for anti-thump start up circuits while maintaining full frequency response from 5 Hz to 20 kHz. Gain balancing trim pots for up to 3 dB are included on the rear part of the frame. For special multi-channel applications the amplifier's variable gain controls are direct current circuits, which are mounted independent of the amplifiers on the dedicated frame; this permits the amplifier gain to be remotely controlled by pre-programmed sources at a rate of 1dB/Volt. Oversized power supply filter capacitors supply high peak energy for those dynamic power peaks that occasionally occur in movie sound tracks. Heavy duty mechanical chassis, state-of-the-art thermal design eliminating mechanical cooling fans, conservatively rated power components combined with Signalgard's protective circuitry make this an amplifier exclusively designed for reliable theatre use.

## SPECIFICATIONS

### Amplifier Electronics:

Power Bandwidth: 2 Hz to 30 kHz.  
Noise: -68dBv.  
Total Harmonic Distortion: .08%  
I.M. Distortion: .15%.  
Input Impedance: 20 kOhms, balanced.  
Input Volts for Rated Output (8 Ohm): 1.50 Volts.  
Rise and Fall Time: 2 microseconds.  
Slew Rate: 15V/microsecond.  
Channel Separation: -76dB.  
Rated Power Output per Channel into 8 Ohms\*: 75 Watts.  
Rated Power Output per Channel into 4 Ohms\*: 110 Watts.

\*Individual channel power output measured with all channels loaded to rated output.

## MECHANICAL SPECIFICATIONS:

Dedicated Frame: 19" Rack Width x 10½" Height x 15½" Deep  
(holds three amplifier modules)

## ELECTRICAL REQUIREMENTS

Power: 115/240 Volts, 50/60 Hz, 600 Watts, 5 Amps.  
Circuit Breakers: 2 Breakers, one in each primary winding, 6 Amps each.

\*Specifications are subject to change without notice.

\*\*"Kintek" and "Digimate" are trademarks of Kintek, Inc.

**WARRANTY AND REPAIR:** Equipment manufactured by Kintek carries a limited warranty against defects in material and workmanship for two years from the date of purchase.

#### 4. Kintek Digimate 1100 Power Amplifier

The Kintek Digimate 1100 Amplifier is a four channel modular amplifier. Each amplifier power supply has dual rectifiers and filters. The amplifier is fitted with male connectors on the rear panel which mate with matching frame connectors. All connections to system sources and loads are made through barrier type terminal strips mounted on the frame, so the amplifier can be removed or installed in the rack in a matter of a few seconds. Interchangeability and rapid replacement have been design criteria.

The 1100 amplifier has been field proven as a reliable, continuous output, high power workhorse. Its installation requirements should be carefully noted and observed. Ambient temperature and free availability of air supply should be considered when installing the system. Normal good housekeeping standards should be observed especially in regards to dust and airborne dirt.

The Digimate 1100 amplifier has been designed for convection cooling. Many amplifier designs have used forced air blowers to carry off the generated heat. With forced air, the failure of the blower fans results in amplifier shut down or failure in those units not having thermal protection systems. If the 1100 amplifier is installed according to Kintek recommendations, the amplifier should operate trouble free at full power for many years.

The 1100 amplifier is a fixed gain unit. It has a high impedance input circuit, balanced to ground. Its common mode rejection with balanced input will help maintain hum free circuits, especially if there is a long run from the driving amplifier. It can be operated as a single ended input however, but common mode rejection will be eliminated and greater care will have to be exercised to keep induced hum levels down.

The output circuit is unique, it is possible to overload the output without damage to the power stages. The amplifier is designed to operate without destroying itself. The output circuit monitors operating parameters that determine the Safe Operating Area for the amplifier. The circuit responds instantaneously to prevent excess currents from destroying the output stage.

Unlike some designs, this circuit does not cut off the output signal. The result is an amplifier that can be overdriven or overloaded without losing the output signal. It continues to stay within its safe operating area for current and voltage parameters.

#### 4. KINTEK KT-1100 POWER AMP CONTINUED:

In addition, the 1100 can maintain high average output levels without audio clipping. Internal circuits continuously monitor signal conditions and momentarily reduce the gain when an excessive signal level is detected. This signal conditioning is performed free of any audible distortion, it adds about 12dB of compressed guard band before clipping.

To protect the loudspeakers from high voltages, the amplifier will shut down if a DC offset of +/- 6 volts is detected at the output.

The 1100 has dual power supply rectifiers, regulators and filters. This means if a rectifier, regulator or filters fails, the second channel supply will continue uninterrupted. The power supply has been designed into the Safe Operating Area loop and will not be exceeded if the amplifier is installed properly.

The power transformer has been designed to operate even at high temperatures and transfer internally generated heat to the heat sinks. The bobbins for the coils will withstand temperatures up to 200 degrees C. It is highly efficient, a small transformer that is able to produce large amounts of power. Heat conducting epoxy has been used for potting the transformer.

The AC line voltage is 110 or 220 Volts. The unit is normally set up for 110 Volt operation at the factory.

There are circuit breakers on the power transformer primary windings. To reset if a circuit opens, push the button located on the front panel up. The amplifier should then operate normally.

A mute switch is on the front panel. It permits muting the channel on the side of the amplifier on which it is located. When the red LED is lit, that channel is muted. Otherwise the green LED will be lit.

On the front of the amplifier is an LED marked OVERLOAD. If the output stage of the 1100 is driven into circuit limiting this LED will light. IF this occurs, the reason for the overload should be determined and eliminated.

The 1100 amplifier is to be installed in the center slot of the KT-2020 rack. This rack has large perforated top and bottom cover plates. This provides convection cooling of the output stage. It is important that the rack in which this amplifier is installed has adequate venting below the amplifiers to allow a sufficient supply of cool air. The top of the frame should have an open area for venting the hot air through the top surface.

#### 4. KINTEK KT-1100 POWER AMP CONTINUED:

The area for relieving the heat above the amplifier should be screened with a mesh and should have an effective open area of at least 175 square inches. The area below the amplifier should be similarly sized to allow cool air supply. In a small enclosed room, adequate venting of the room is also important to prevent excessive heat build up.

The AC power is connected to the back of the rack frame. At peak output the amplifier can draw as much as 6 1/2 amps. The AC feed should be capable of delivering approximately 7 amps.

The 1100 amplifier has protective circuits to eliminate transient thumps during power up and power down. No special start up procedures need be taken.

If a center channel amplifier should fail, and OVERLOAD LED will light. The system may be operated in mono by removing, inverting and re-installing the amplifier: loosen the top and bottom thumb screws, slide the module out of the frame, turn it upside down, slide it back in place and tighten the thumb screws. The amplifier which had been driving the surrounds will now power the center channel.

DIGIMATE 1100 POWER AMPLIFIER MODULE  
CONNECTOR DESIGNATIONS

AJ1

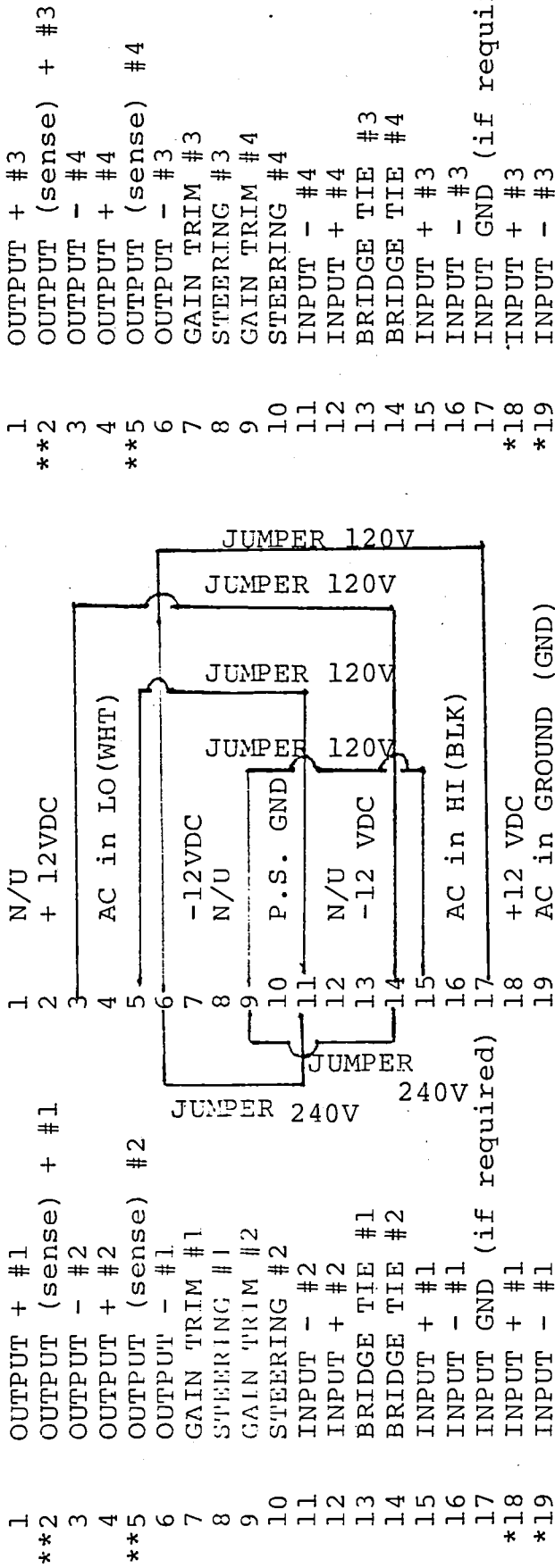

CJ2

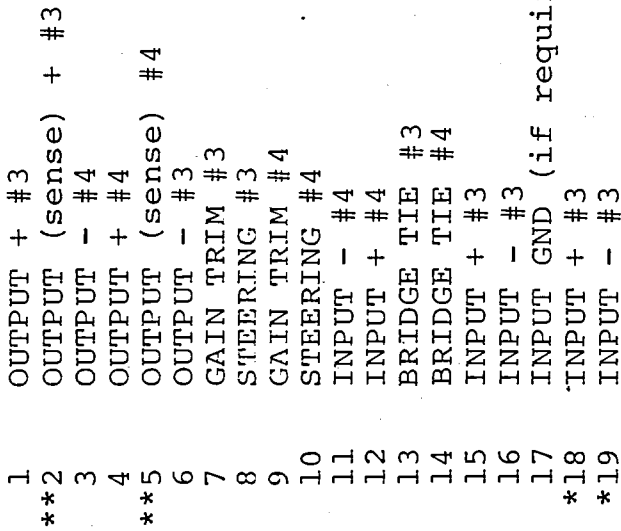

BJ1

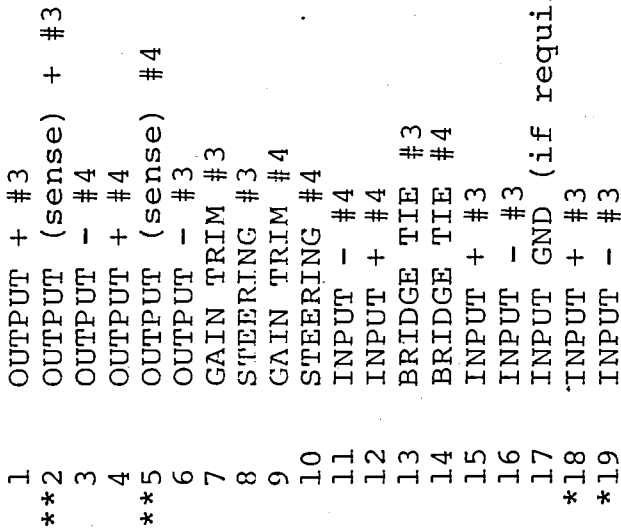

\*ALTERNATE INPUTS  
\*\*ALTERNATE OUTPUTS

RECOMMENDED WIRE SIZES--OUTPUTS: 14 to 16 gauge stranded, INPUTS: 20 to 22 gauge stranded



## 5. KT-1045 Exciter Lamp Supply / Monitor

### Exciter Lamp Supply Features

The exciter lamp power supply can deliver up to six amps of regulated direct current with voltage adjustable from 3.5 to 9.5 volts. The 110 volt AC supply is connected at CJ2 pin 4 (low) and pin 16 (high). The output to the exciter lamp is supplied through BJ1 pin 9 (ground) and pin 10 (positive).

On the front panel 3 LEDs indicate the output status of the KT-1045: Green = normal DC output. Yellow = emergency 5 volt AC operation due to DC supply failure. Red = low or no voltage at the output. If the factory set current limit of 6 amps is exceeded, the red LED marked SHORT will light.

### Monitor Adjustment Procedure

Turn on the power amplifiers. The monitor level trim controls are located on the rear of the module. From top to bottom the controls are: Left surround, Right Surround, Low Freq, Center High Freq, Center Low Freq, Center Combined.

Lace up and roll the pink noise loop. Select SYN format. Push the monitor select switch until the Center High Freq LED is lit. Adjust the Center High Freq trim to light the -24 level indicator on the front panel. Select Center Low Freq and repeat level adjustment. Repeat the procedure for the remainder of the level trim pots. The monitor automatically returns to Center Combined after a short time. See 2.5 on page 5-5 for way to defeat this automatic feature.

### Fuse Type and Location

There are two fuses mounted in clips at the top edge of the circuit board inside the module. A 2 amp, 250 volt slow blow power transformer primary fuse is located to the rear of the unit. A 10 amp slowblow is located closer to the panel. This fuse is in circuit between the transformer secondary and the DC rectifier. The unit will switch to AC operation if this fuse is open or removed.

A 10 amp slowblow is located just forward of the PC board and is wired in the emergency AC feed. A 1/4 amp slow blow protects the monitor audio amp. It is located against the rear panel of the module next to the dip switch.

## 2.2 INPUTS

Low frequency input (for subwoofers) impedance is more than 100K. The input is differential. Frequently subwoofers are driven by bridged amplifiers so that LF+ is connected to one speaker feed line and LF- is connected to the other speaker feed line, the loudspeaker itself is floating. The way both drive amplifiers can be monitored for noise and distortion at once (complete failure of one amp would still provide 1/2 signal on the monitor although the auditorium would not be fed). The differential input is also provided because some subwoofers (such as Kintek KT-90) are self powered at the speaker and have low level balanced 500 ohm audio pairs fed to the auditorium stage. In this case the unit monitors the feed line and it must be balanced because the subwoofer amp input is balanced. This input also can be fed unbalanced by connecting LF- to the feeding amplifiers ground.

All other inputs are 15K ohms input impedance or higher and are single ended. The grounds of all power amps must be connected together and connected to the common ground of the monitor amp.

Figure 2  
Calibration Pots.

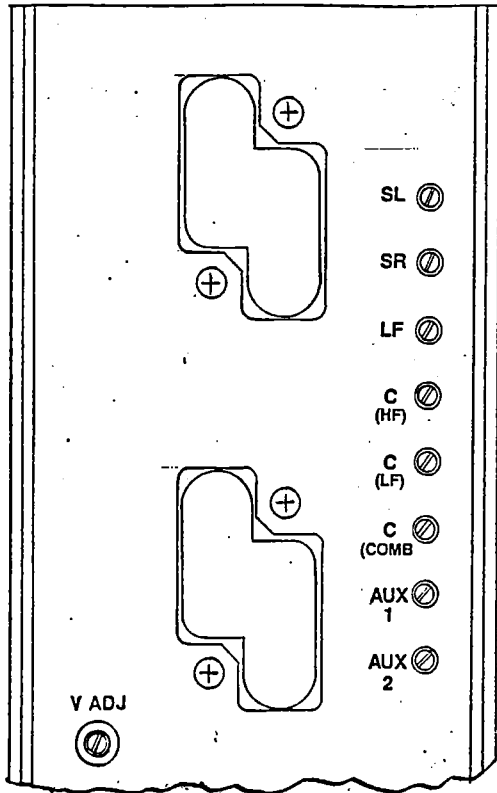
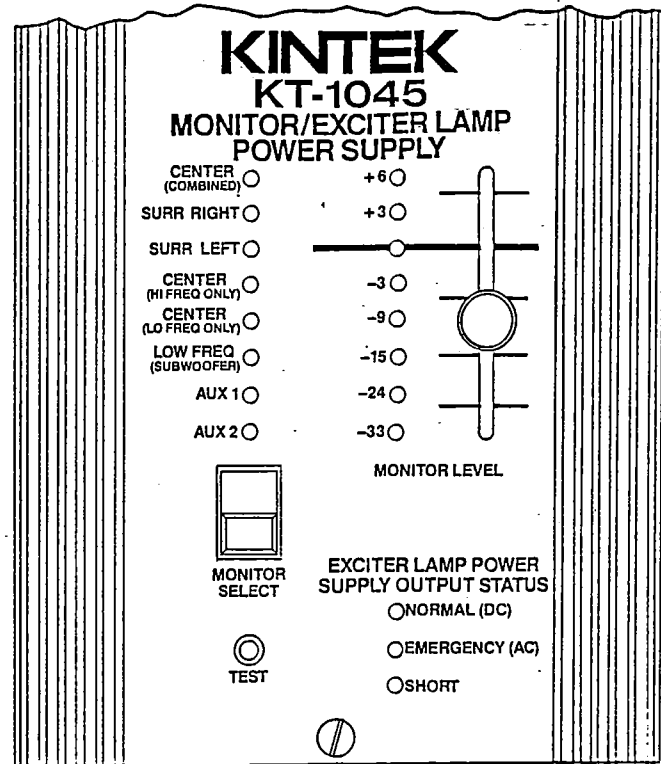

Figure 3  
LED Indicators



6.2.3 SENSITIVITY

The sensitivity of the inputs is set for normal use to monitor the outputs of the power amps to the auditorium loudspeakers. If more sensitivity is required, such as when monitoring line level feeds, it would become apparent when calabrating, having insufficient gain on the trim pots 20 dB more gain can be switched in by switching dip switches to off position. The switches are located inside on the top end of rear panel board see fig. #5

Both switches for Low frequency must be switched together to maintain balance. The switches in L.F. change gain 10 dB.

To raise sensitivity of Aux #2 open Jumper Y1.

Figure 4

- S1-1 Aux 1
- S1-2 Center (Combined)
- S1-3 Center (Low frequency)
- S1-4 Left Center (High freq.)
- S2-1 L.F. (Both must be
- S2-2 L.F. switched together)
- S2-3 Surround Right
- S2-4 Surround Left

Switch assignments for sensitivity change. ON is low, OFF is high sensitivity

Figure 5

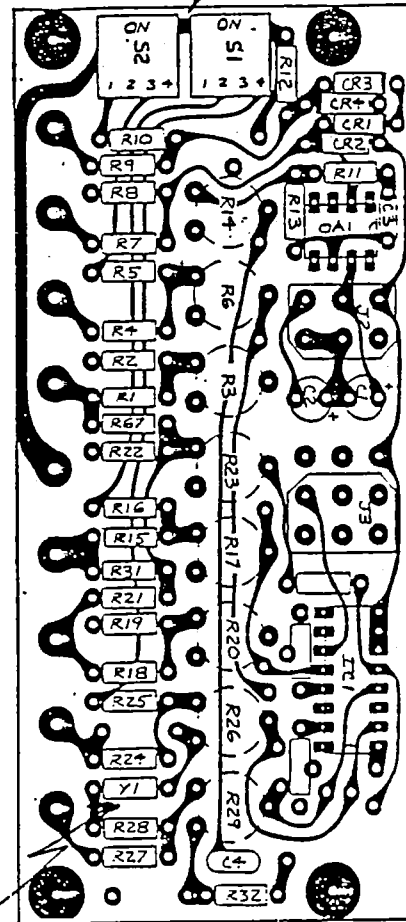

Location of switches and Y1 on rear connector board

#### 2.4 Selector Switch

When shipped from factory, the monitor selector switch can select all input positions. If not all inputs are connected it may be desirable to limit the number of monitor positions. This may be done by setting "dip" switches at bottom of front panel switch board.

Figure 6

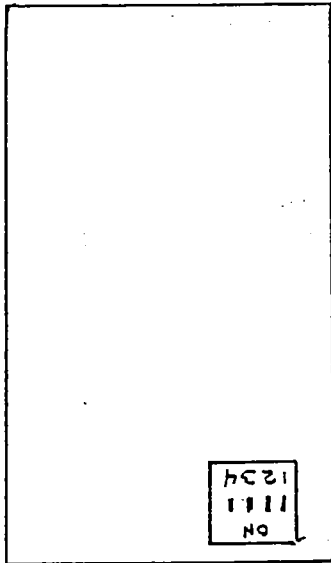

Front panel  
switch board.

Figure 7

	Switch 1	Switch 2	Switch 3
Center (Combined)	off	off	off
Surround Right	on	off	off
Surround left	off	on	off
Center (High freq)	on	on	off
Center(L.F. right)	off	off	on
LF(subwoofer) LCR	on	off	on
Aux 1	off	on	on
Aux 2	on	on	on

Truth table for monitor select dip switch. The configuration indicates the last position from the bottom that can be monitored when stepping through selections.

2.5 MONITOR AUTO RETURN DEFEAT

Switch section #4 on switch (illustrated in figure 6 above) on front panel board, when on, will defeat the feature that returns the monitor amp to the center speaker automatically.

## APPENDIX A

### KINTEK CENTER/SURROUND STEREO

The KT-1003 center/surround system processes the four channel information encoded in SVA soundtracks to deliver a spacious stereo sound field. Subjective directionality intended by the sound mixer is maintained.

A center stage loudspeaker and two banks of surrounds are used. Each surround bank, designated Left Surround or Right Surround, is fed from a separate power amplifier. The center stage loudspeaker reproduces the same program material as its counterpart in a four channel system. The surround array reproduces the same program as a four channel system plus left and right information.

A unique decoding matrix was developed to make left/right directionality in the surrounds possible. The KT-1003 accurately monitors the two optical tracks and makes dynamic adjustments to Center, Left Surround and Right Surround levels.

For example, consider a film scene with significant screen left action. The apparent origin of the sound effects should match the picture. This would be accomplished by recording the effects at a higher level on the left optical track than on the right.

During playback, the decoding matrix simultaneously attenuates center and right surround levels, and boosts the left surround level by an amount that will establish a left side directionality. Loudspeaker levels are carefully controlled to provide good subjective localization and correct sound pressure levels at all times.

The result is a dynamic sound field with directionality that correlates well with screen action.