

FILM-TECH

THE INFORMATION CONTAINED IN THIS ADOBE ACROBAT PDF FILE IS PROVIDED AT YOUR OWN RISK AND GOOD JUDGMENT.

THESE MANUALS ARE DESIGNED TO FACILITATE THE EXCHANGE OF INFORMATION RELATED TO CINEMA PROJECTION AND FILM HANDLING, WITH NO WARRANTIES NOR OBLIGATIONS FROM THE AUTHORS, FOR QUALIFIED FIELD SERVICE ENGINEERS.

IF YOU ARE NOT A QUALIFIED TECHNICIAN, PLEASE MAKE NO ADJUSTMENTS TO ANYTHING YOU MAY READ ABOUT IN THESE ADOBE MANUAL DOWNLOADS.

WWW.FILM-TECH.COM

KT-2010Z SOUND SYSTEM

Installation and Operation

Kintek, Inc.
224 Calvary St.
PO Box 9143
Waltham, MA
02254-9143

December 1988

TABLE OF CONTENTS

CHAPTER

1	KT-1000Z Front Panel Controls	1
2	Internal controls + Automation	3
3	System connections + calibration	4
4	Digimate 1100 power amplifier	7
5	KT-1045 monitor/exciter lamp supply	12
6	Set up procedure when installing new Solar Cells in projector	14



TABLE OF FIGURES

FIGURES

1	KT-2020 With KT-1000Z	after page 4
2	Non/Sync inputs connections	after page 4
3	Biamp system adjustments	after page 6
4	Power Amplifiers assignments in KT-2020 System	after page 6
5	Digimate 1100 power amp connector	after page 9
12	Placement of Solar Cell	
14	Azimuth Adjustments of X/Y Oscilloscope	
15	Left/Right Film on Dual Trace Oscilloscope	
16	Slit loss adjustment shown on real time analyzer	
19	Oscilloscope X/Y Patterns	
20	Test Films	

Warranty and Repair

Equipment manufactured by KINTEK carries a limited warranty against defects in materials and workmanship for two years from the date of purchase. Kintek will, at its option, repair or replace defective components provided the unit is shipped to KINTEK or its authorized distributors with a Return Authorization(RA) Number. Defects caused by modification, misuse or other damage caused by improper packing are not covered by this limited warranty.

In the event you have a problem, call your equipment dealer and list specifically the symptoms; it will often speed up the repair.

NOTE: KINTEK are manufactured under one or more of the following US patents: 3,681,618; 3,714,462; 4,101,849; 4,097,767. (Canadian patents) 4,589,129; 1,153,701. Other patents pending.

QUICK REFERENCE GUIDE

AUTOMATIC FAILURE DETECTION AND BYPASS BUTTONS--Each module in the KT-700 is equipped with an operator's warning system that alerts you to a failure immediately.

The RED LED next to the BYPASS button is flashing----
-----push the BYPASS button(this removes the module from the chain without disturbing any other function).

KT-742 PREAMP--the RED warning LED is flashing-----
MAL(malfunction), push the EXCHANGE button on the KT-742 front panel. Notify management for service.

KT-728 INPUT SELECT SWITCHES--To operate manually, push the AUTO button to override the automation.

KT-721 EXPANSION SELECT SWITCH--Normal operation is 1.2(20%).
Music & effects are too loud and dialog is too soft----
--select 1.1(10%) expansion.

KT-724 SURROUND LEVEL & LOW FREQUENCY LEVEL CONTROLS--normal operation is for both controls to be at 12 o'clock. A minimal level increase or decrease can be given to the surrounds for fine tuning. Increasing the low frequency level increases the amount of subharmonic signal mixed with the original bass signal and the level.

FOR MONO FILMS: The KT-700 automatically synthesizes Mono films into 4 to 7 channels depending on the options included with the system.

FOR STEREO FILMS:

When equipped with a KT-750, Stereo Optical Processor, there is no need to switch the unit into SVA process when screening a stereo print. The KT-750 detects the stereo print in the projector and changes over automatically to SVA process and adjusts the theatre level; it will not change back to stereo synthesize until the KT-700 is switched to NON-SYNC, or the bypass button on the KT-750 is pushed. To lock into SVA process, push the OPERATE button on the KT-750.

Chapter 1

KT-1000Z FRONT PANEL CONTROLS

1.1 MASTER FADER.

The MASTER FADER is made up of two concentric controls: the Vernier Control, the bottom section of the knob, and the Master Gain Control, the top section of the knob.

The Master Gain is normally set at "7", however, there is another 12dB of reserve gain provided between "7" and "10"; this control can fade to infinity. Ordinarily, the Master Gain can remain at the setting used for the feature presentations. Center, surround and low frequency outputs maintain their correct balance for any setting of the Master Gain.

The Vernier Control is normally set at "5". You can raise or lower the gain 6dB from its normal position while allowing the Master Gain to remain constant.

1.2 SURROUND LEVEL CONTROL.

The SURROUND LEVEL control will permit minor changes in the surround level; its normal position is straight up.

1.3 MODE SWITCH.

The MODE switch, a rocker switch with LED indicators, has three positions: NON/SYNC, PROJ, and AUTO.

The upper, NON/SYNC position turns off the SVA format. This enables the NON/SYNC input to fade in and mute the input from the projector preamp.

When the Mode switch is set at PROJ, the NON/SYNC is faded out and the projector preamp is "soft" switched on. The internal stereo detector will not operate when the system is in the PROJ mode.

At the AUTO position, external automation will select NON/SYNC or Projector with the same mute and fade functions as with manual switching, the appropriate LED will be lit. The AUTO position will allow the internal stereo detector to select the SVA when a stereo film is played. Returning to NON/SYNC either manually or by automation will change the format from SVA to SYN automatically.

NOTE: If the system has been wired so that the External Automation has control of format, then the front panel push button and stereo detector are disconnected. The SVA or SYN LEDs will indicate which format has been selected.

1.4 FORMAT PUSH BUTTON.

The FORMAT push button, with LED indication, selects either SVA(stereo) or SYN(synthesizer).

1.5 EMERGENCY BYPASS SWITCH.

When the EMERGENCY BYPASS Switch is pressed, a reserve mono input is connected to the solar cell, this is connected directly to the center processor output. The level is controlled by the Bypass Level Trim Control. This control, labeled BYP LEVEL, can be found behind the removable plate on the front of this unit.

1.6

There is an Emergency bypass switch for the crossover unit only located in the back of the KT-1000 module reachable through the rear of the frame.

Chapter 2

INTERNAL CONTROLS AND AUTOMATION

2.1 LOCATION AND DEFINITION.

2.1.1 PREAMP CARD--left-hand card when looking down inside the KT-1000 module from the front. There are two switches on the card, both will be preset at the factory.

Slide switch at top edge of board--determines whether SVA format can be turned ON by Remote Control (forward position) or by Internal Detector (back position). The Internal Detector setting allows the front panel controls to activate the SVA Mode. The Remote Control setting is used if you are going to operate the SVA from automation; this setting will override the other mode controls. The unit is set at the factory in the Internal Detector or back position. NOTE: When pin 7 on TBI is momentarily grounded, the system will be in synthesizer mode (mono). If pin 6 is momentarily grounded the system will shift to SVA (refer to figure 1, KT-2010 System Frame Wiring). When unit is configured for automation the unit will be in SVA when the power is first applied.

Slide Switch in center of board--determines if the solar cell is set for Mono (back position) or Split solar cell (forward position). When connecting a Mono solar cell, connect the cell to the right cell input and let the left input terminals float. The unit is factory set in the Split solar cell position.

MODE Switch--described in section 1.3, Front Panel Controls. If the AUTO position is selected, grounding TBI terminal 10 will select NON/SYNC. Projection is selected letting terminal 10 float (refer to figure 1).

Surround Delay Trim Potentiometer-- located behind a small hole on right-side of the module. (The module must be slid out of the frame to view this location.)

<u>Setting</u>	<u>Delay</u>
Fully counter-clockwise	--25 milliseconds
10 o'clock	--45 milliseconds
12 o'clock	--60 milliseconds
2 o'clock	--75 milliseconds
Fully clockwise	--90 milliseconds

The unit comes factory set with a 60 millisecond delay. The amount of delay is determined by the distance from the screen to the last row of seats minus the distance from the last surround speaker plus 20 milliseconds.

Chapter 3

SYSTEM CONNECTIONS AND CALIBRATION

3.1 CONNECTIONS--refer to figure 1.

--Center Loud Speaker High Frequency Driver--connect to TB2 terminals 1 (plus) and 2 (minus); connect these to the driver in phase. On a rack mount unit these terminals are found on the back of the main frame on the left side, when you are looking from the rear. If the unit is pan mounted, the connections are made in the lower terminal block.

--Center Loud Speaker Low Frequency Driver--connect to TB2 terminals 3 (plus) and 4 (minus); connect these to the driver in phase.

--Surround Speakers, Left Group--connect to TB2 terminals 5 (plus) and 6 (minus).

--Surround Speakers, Right Group--connect to TB2 terminals 7 (plus) and 8 (minus).

NOTE: The groups of surround speakers should be interconnected in phase so that the load impedance to the amplifier is not less than 4 Ohms.

--Solar Cell--connect solar cell lines to TB1, on the right side, terminals 11-14, according to the diagram.

--Automation (optional)--connect to TB1 terminals 6-10. For an explanation of Automation requirements, refer to chapter 2, Internal Controls and Automation.

--Non/Sync Input--connect to TB1 terminals 17-18. This is a balanced or differential input, refer to figure 2 for sample hookups.

--Exciter Lamp--connect to TB2 terminals 15 & 16.

--Low Frequency Lines, KT-90--(will be connected during calibration process) connect to TB2 terminals 9-11. Single ended input should be connected to 9 (high) and 11 (ground). This is for a differential input such as on KT-90, 9 (high), 10 (low) and 11 (shield).

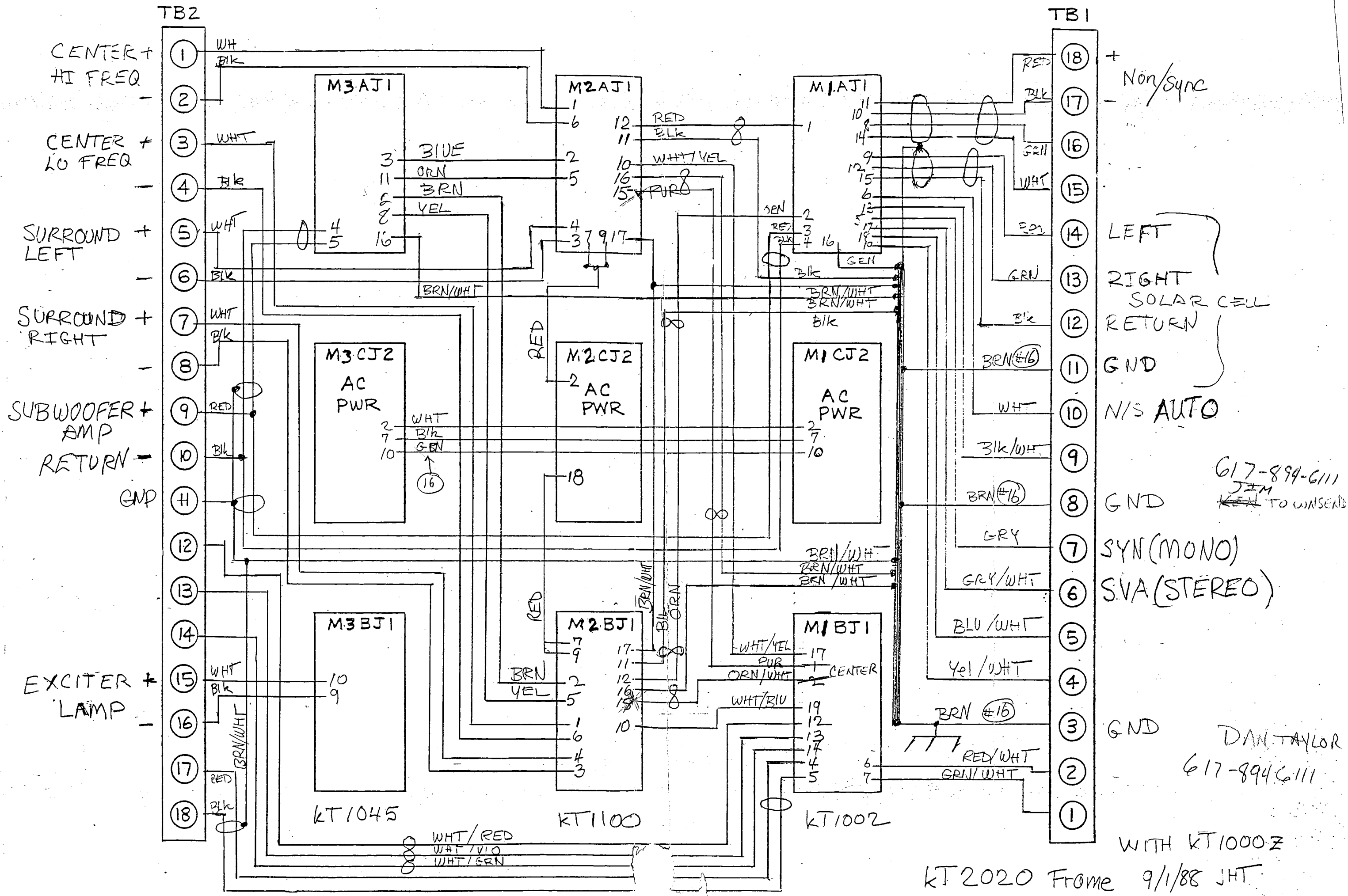

KT2020 Frame 9/1/88 JHT

FIGURE #1

Non/sync connections for Stereo or mono feed, balanced or unbalanced.

Stereo feed - balanced output.

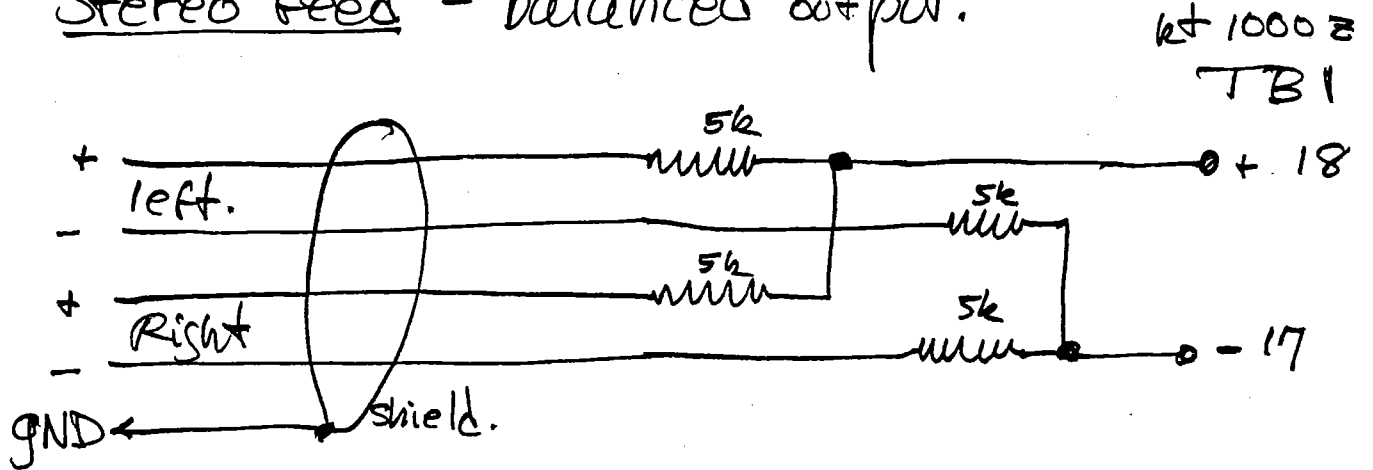

Stereo feed - unbalanced output.

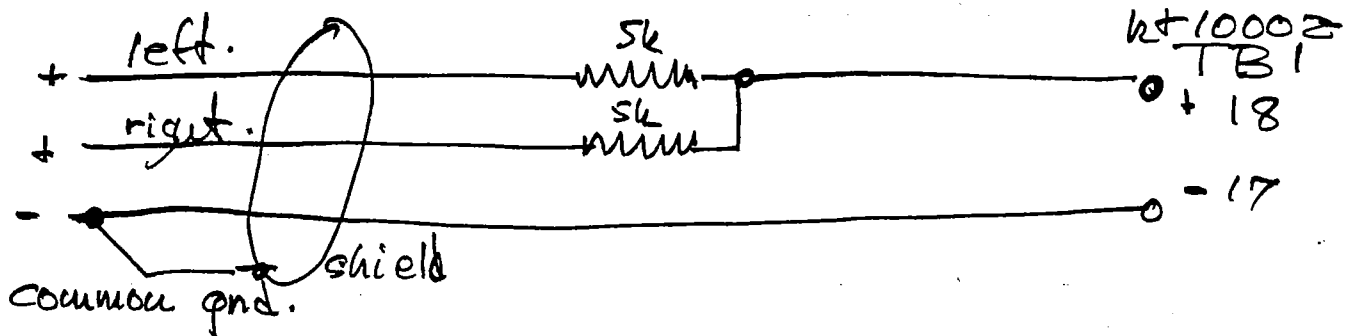

mono feed - balanced output.

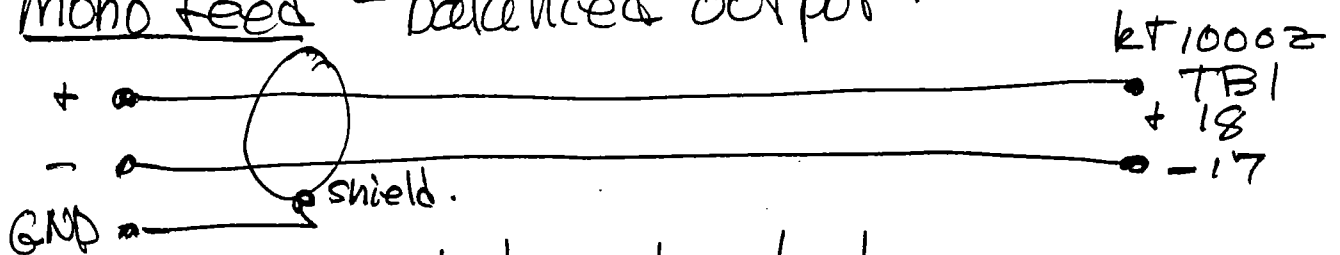

Unbalanced output.

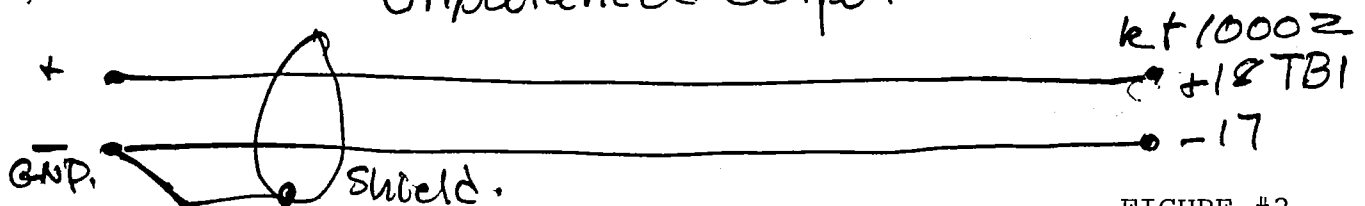

FIGURE #2

3.2

BIAMP ELECTRONIC CROSSOVER/ LOW FREQUENCY TIME DELAY HIGH FREQUENCY EQUALIZER

The crossover is made up of active crossover filter sets for biamp service providing steep filtering for the protection of the high frequency driver (dB attenuation at the driver resonant frequency). Phase compensation keeps high and low frequency drivers in phase through the crossover region. Time delay in the low frequency filter makes the low frequency driver speak simultaneously with the high frequency horn, which has a longer air path. The delay is adjustable from .7 milliseconds minimum to 2.2 milliseconds maximum. A built in oscillator provides ease in adjustment; the circuit design uses modified Bessel criteria.

There is high frequency attenuation to compensate for differences in efficiency in the high and low frequency drivers, adjustable from 5 to 15 dB attenuation; and variable equalization to compensate for very high frequency loss in the high frequency horn. Also, there is unity gain through the low frequency drivers, adjustable +/- 1 dB called L.F. match. The noise level is -90 dB and the distortion is .08% THD with reference to 1 volt input for either high or low frequency for any setting of delay. The maximum input before clipping is +18 dB, which is more than 10 dB greater than is required to drive the power amplifiers to full output. The input is differential with 40 dB common mode rejection. There is a high pass filter to protect the woofers against excess drive below 30Hz.

The outputs have antithump circuits to protect the speakers when the system is turned on and off. There is an Emergency Bypass, providing a passive crossover network to protect the high frequency driver.

3.3

ADJUSTING THE BIAMP SYSTEM

The controls to adjust the Biamp System are at the rear of the KT-1000 unit which can be reached through the back of the frame and adjusted while the unit is powered.

To Adjust Delay: You will need a sound pressure meter placed on a line perpendicular to the faces of the speakers, equidistant from the high frequency horn and the nearest low frequency driver. Select the delay range. The five position rotary switch. Position 1 (the most counterclock) is .7 to 1.0 milliseconds, Position 2 is 1.0 to 1.3 ms and Position 3 is 1.3 to 1.6 ms (this is the factory setting. Position 4 is 1.6 to 1.9 ms, Position 5 is 1.9 to 2.2 ms. Make sure Low Frequency Crossover adjust is set in mid position. Next turn ON the built in oscillator switch labeled Test Tone. Turn ON the low frequency amp and measure the SPL. Next, with the high frequency amp on set the HIGH FREQUENCY LEVEL (HF Level), so the SPL is the same as through the low frequency amp. Turn ON both center amplifiers, the SPL should rise by 5 to 6 dB. Optimize by adjusting the fine DELAY for maximum SPL. An alternate, more accurate, method is to reverse the polarity by switching the polarity of the high frequency leads. The correct delay time will be indicated by a null on the SPL meter. The depth of this null will depend upon the amount of reflections in the room and the accuracy to which the high and low frequency levels were set. Also, try moving the SPL meter closer to the speakers for less interference. Return the connections to the high frequency driver to its normal polarity. Turn off the built-in oscillator. With a spectrum analyzer and pink noise reset the HIGH FREQUENCY LEVEL so that there is a balanced drive to both high and low frequency drivers. Also set High Frequency equalization to match High Frequencies between 4 khz + 12 khz to desired curve.

COURSE DELAY ADJUST: 5 position switch
 .7 to 1.1ms, 1.1 to 1.5ms, 1.5 to
 1.9ms, 1.9 to 2.3ms, 2.3 to 2.7ms.

BYPASS: Front panel control of bypass.
 Inserts passive crossover. Normal
 switch position is OUT.

TEST TONE: push to activate test tone
 for adjusting time delay.

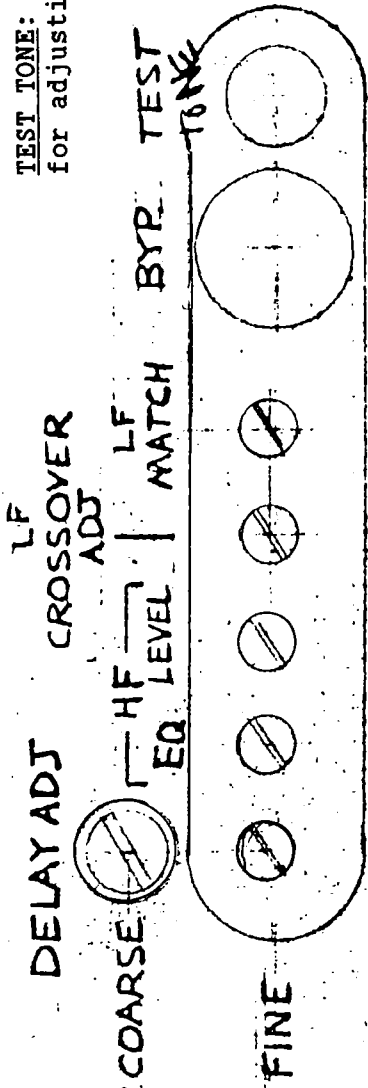

FINE DELAY ADJUST: adjusts delay over
 a .4 ms range.

HIGH FREQUENCY EQUALISATION: hinged at
 4khz, varies from +3 to +14 db at
 12khz to compensate for high frequency
 loss in the horn.

LOW FREQUENCY MATCH: adjusts for unity
 gain from input to output through low
 frequency filter. Range 1db. Factory
 set.

LOW FREQUENCY CROSSOVER ADJUST: moves
 the low pass filter frequency
 slightly. This can be used, after
 other adjustments have been completed,
 to correct a peak or a null right at
 the 500 hz crossover frequency. Before
 making this adjustment, try making
 phase reversal to the horn driver.

HIGH FREQUENCY LEVEL: sets level
 compensation for the difference in
 efficiency between woofer and
 horn. This continuously variable
 control attenuates 5db min. 15db max.

POWER AMPLIFIER ASSIGNMENTS IN KT-2020 SYSTEM

AMP#1	Center Hi Frequency
AMP#2	Surround Left
AMP#3	Center Low Frequency
AMP#4	Surround Right

DIGIMATE 1100 AMPLIFIER

- **TOTALLY VERSATILE.**
- **SIGNALGARD CIRCUIT PROTECTION.**
- **STATE-OF-THE-ART THERMAL DESIGN.**
- **CLEAN, QUIET OPERATION.**
- **START-UP SPEAKER PROTECTION.**
- **QUALIFIED FOR MAJOR MOTION PICTURE USE.**

The Digimate 1100 is a versatile four channel modular amplifier designed to fill the needs of a wide variety of theatres. Each 1100 amplifier module can be configured as four 75 Watt per channel amplifiers, two 220 Watt per channel bridged amplifiers or a combination of both. The dedicated Digimate 1100 frame can be fitted for as many as three 1100 modules, making twelve power amplifier channels available for large scale, multi-channel sound systems; yet it is also perfect for use in Center/Surround Sound Systems. Electronic flexibility and modular expansion capability gives the theater designer maximum performance in the least amount of booth space, whether the theatre is large or small.

The Digimate 1100 quad amplifier output circuitry is similar to that used in the successful Digimate® 1010 and 1110; it gives them the reputation of being "bulletproof." It's possible to over-drive the amplifier without destroying the output stage because of its built-in Signalgard circuit. Signalgard is an internal system monitor which assures the power stages of always being well within their Safe Operating Area (SOA). But even more important to the theatre's patrons,

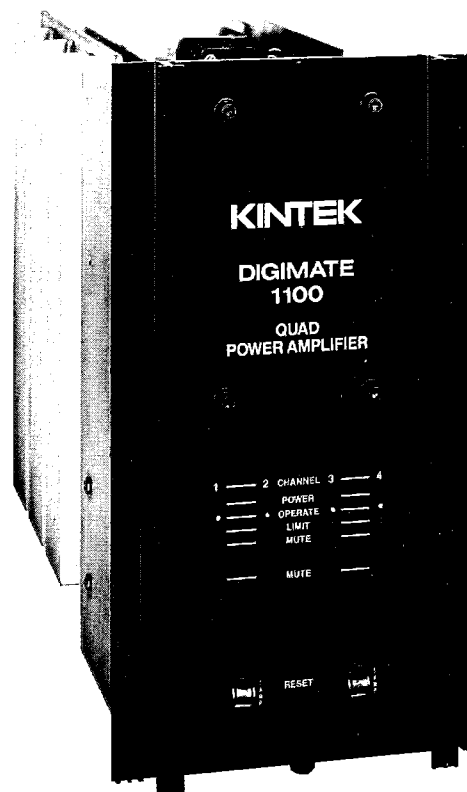

Signalgard never shuts the Digimate 1100 down, even when over-driven for long periods. Signalgard will always keep the 1100 amplifier operating within its SOA. A comprehensive set of LED indicators on the amplifier's front panel indicate power on, limiting and mute for each of the channels.

One of Signalgard's unique characteristics is its ability to maintain high average output levels without audio clipping. Its internal circuits continuously monitor signal conditions and momentarily reduce the gain when an excessive signal condition is anticipated. This signal conditioning is performed free of any audible distortion; it adds about 12 dB of compressed, distortion-free guard band level before clipping during occasional periods when the amplifier is overdriven.

KINTEK

KINTEK, INC., 224 Calvary St., PO Box 9143, Waltham, MA 02154-9143 (617) 894-6111

The 1100's versatility to accepting various load impedances is a valuable feature. When operated as four single channel amplifiers, each amplifier can drive 8 Ohm loudspeakers to 75 Watts. The same amplifier can drive 4 Ohm loudspeakers to 110 Watts per channel. When the amplifier is loaded with 4 Ohm loudspeakers, a very demanding condition for any amplifier, Signalgard will manage the internal circuit conditions to prevent signal clipping and internal amplifier destruction; under these conditions the amplifier can be over-driven by up to 12 dB before clipping occurs.



KINTEK, INC.
224 Calvary St.
PO Box 9143
Waltham, MA 02154-9143
(617) 894-6111

SPECIFICATIONS

Amplifier Electronics:

Power Bandwidth: 2 Hz to 30 kHz.
Noise: -68dBv .
Total Harmonic Distortion: .08%
I.M. Distortion: .15%.
Input Impedance: 20 kOhms, balanced.
Input Volts for Rated Output (8 Ohm): 1.50 Volts.
Rise and Fall Time: 2 microseconds.
Slew Rate: 15V/microsecond.
Channel Separation: -76dB .
Rated Power Output per Channel into 8 Ohms*: 75 Watts.
Rated Power Output per Channel into 4 Ohms*: 110 Watts.

*Individual channel power output measured with all channels loaded to rated output.

MECHANICAL SPECIFICATIONS:

Dedicated Frame: 19" Rack Width x 10½" Height x 15½" Deep
(holds three amplifier modules)

ELECTRICAL REQUIREMENTS

Power: 115/240 Volts, 50/60 Hz, 600 Watts, 5 Amps.
Circuit Breakers: 2 Breakers, one in each primary winding, 6 Amps each.

The differential input circuit is fully balanced to ground; it minimizes common mode noise and eliminates ground loops. AC coupling is used in the amplifier, eliminating the need for anti-thump start up circuits while maintaining full frequency response from 5 Hz to 20 kHz. Gain balancing trim pots for up to 3 dB are included on the rear part of the frame. For special multi-channel applications the amplifier's variable gain controls are direct current circuits, which are mounted independent of the amplifiers on the dedicated frame; this permits the amplifier gain to be remotely controlled by pre-programmed sources at a rate of 1dB/Volt. Oversized power supply filter capacitors supply high peak energy for those dynamic power peaks that occasionally occur in movie sound tracks. Heavy duty mechanical chassis, state-of-the-art thermal design eliminating mechanical cooling fans, conservatively rated power components combined with Signalgard's protective circuitry make this an amplifier exclusively designed for reliable theatre use.

*Specifications are subject to change without notice.

**"Kintek" and "Digimate" are trademarks of Kintek, Inc.

WARRANTY AND REPAIR: Equipment manufactured by Kintek carries a limited warranty against defects in material and workmanship for two years from the date of purchase.

Chapter 4

DIGIMATE 1100 POWER AMPLIFIER

4.0 Introduction.

The Kintek Digimate 1100 Amplifier is a four-channel modular amplifier. Each amplifier has its own power supply. Each amplifier power supply has dual rectifiers and filters. The amplifier is fitted with male connector on the rear panel which mate with matching frame connector. All connectors to input equipment and loudspeakers are made through barrier-type terminal strips mounted on the frame, so the amplifier can be removed or installed in the rack in a matter of a few seconds. Interchangeability and rapid replacement have been design criteria in this system design.

The 1100 amplifier has been field proven as a reliable, continuous output, high power workhorse. Its installation requirements should be carefully noted and observed. Ambient temperature and free availability of air supply should be considered in the proper placement of this unit. Normal good housekeeping standards should be observed especially in regards to dust and airborne dirt.

The Digimate 1100 amplifier has been designed for convection cooling. Many amplifier designs have used forced air blowers to carry off the generated heat. With forced air, the failure of the blower fans results in the amplifier shut down or catastrophic amplifier failure in those units not having thermal protection systems. If the 1100 amplifier is installed following the instruction in section 3 of this manual, the amplifier should operate trouble free at full power for many years.

4.1 Circuit Description.

The 1100 amplifier is straightforward. It is a fixed gain amplifier. It has a high impedance input circuit, balanced to ground. Its common mode rejection with balanced mode input will aid in maintaining hum free circuits, especially if there is a long run from the driving amplifier. It can be operated as a single ended input, however, the common mode rejection feature will be eliminated and greater care will have to be exercised to keep induced hum levels down.

The output circuit is unique; it is possible to overload the output without damage to the power stages. The amplifier is designed to operate without destroying itself. The output circuit monitors those amplifiers operating parameters that determine the Safe Operating Area for the amplifier. The circuit responds instantaneously to prevent excess currents from destroying the output stage. It inhibits the output current during those signal periods that would exceed the SOA(Safe Operating Area). This circuit, while more costly than thermal relays or "crow bars" does not cut off the output signal as in those systems which protect by signal cutoff. The result is an amplifier that can be overdriven or overloaded without losing the output signal. The amplifier will always remain on and within the SOA. If the DC offset on the output exceeds +/-6 Volts, the amplifier will shut down. This is done to protect the loudspeaker loading the amplifier. In addition the D1100 can maintain high average output levels without audio clipping. Its internal circuits continuously monitor signal conditions and momentarily reduce the gain when an excessive signal condition is anticipated. This signal conditioning is performed free of any audible distortion; it adds about 12 dB of compressed, distortion-free guard band level before clipping during occasional periods when the amplifier is overdriven.

4.1.1 The Power Supply.

The 1110 has dual power supply rectifiers, regulators, and filters. This means that if a rectifier, regulator or filter fails, the second channel's supply will continue uninterrupted. The power supply has been designed into the SOA loop and will not be exceeded if the amplifier is installed properly.

The power transformer is unique; it has been designed to operate at high temperatures, and to transfer the internally generated heat to the heat sinks. It is highly efficient; a small transformer that is able to produce large amounts of power. Heat conducting epoxy has been used for potting this transformer. The bobbins for the coils will withstand high temperatures up to 200 degrees C.

The AC line voltage for the power transformer is 110 Volts or 220 Volts. The unit is normally set up for 110 Volt operation at the factory.

4.1.2 Circuit Breaker.

There are circuit breakers on the power transformer primary windings--to replace the fuses found on most amplifiers. To reset in the event a circuit has opened, push the button up to reset; the amplifier should then operate normally.

4.1.3 Mute Switch.

A mute switch is on the front panel. It permits muting the channel on the side of the amplifier on which it is located; left switch for the left channel and right switch for the right channel. When the red LED, situated beside the mute switch, is lit, that channel is muted, otherwise the green LED, labeled "OPERATE" will be lit.

4.1.5 Overload Indicator.

On the front of the amplifier is an LED marked "OVERLOAD". If the output stage of the 1110 is driven into circuit limiting this LED will light up. If this occurs, the reason for the overload should be determined and eliminated.

4.2 Installation.

4.2.0 Mechanical Installation.

The Digimate 1100 amplifier is to be installed in the center slot of the KT-2020 rack. This rack has a large perforated bottom and cover plate. This is for the convection cooling, primarily for the heat generated in the output stage. It is important that the rack in which this amplifier is installed has adequate venting below the amplifiers to allow a sufficient supply of cool fresh air. The top of the frame should have an open area for venting the hot air through the top surface. The area for relieving the heat above the amplifier should be screened with a mesh and should have an effective open area of at least 175 square inches. The input area below the amplifier should have a similar input area available for a cool air supply. In a small enclosed room adequate venting of the room is also important to prevent excessive heat build up.

4.2.1 Power Connections.

The AC power connections for amplifier is connected to the back of the rack frame. At peak output the amplifier can draw as much as 6 1/2 amps; the AC feed should be capable of delivering approximately 7 amps.

4.2.2 Signal Input Connections-Balanced Input.

All input connections are located on the terminal block on the left rear panel (refer to Figure 1). Figure 5 lists the proper connections for the inputs. The input polarity should be observed because any polarity reversals can reduce the loudspeakers acoustical outputs field. The input leads should be shielded with the shield tied to the appropriate terminal provided on the terminal block.

4.2.3 Signal Input Connections-Unbalanced Input.

The amplifiers can be driven with unbalanced input signals. To feed the amplifier in the unbalanced mode, the negative input should be grounded with a short jumper wire; the signal should then be fed into the proper + input terminal. The shield should be grounded at the drive point and can be left floating at the amplifier end.

Feeding the amplifier in the unbalanced mode will increase the system's sensitivity to hum; the common mode rejection feature will be eliminated.

4.2.4 Output Connections.

The output connections available on the terminal block are shown on figure #1. The amplifier is capable of high power output and since the load may be located some distance from the amplifier the wire size should be at least #16 for 8 ohm loudspeakers. If the loudspeakers load is 4 Ohms #14 wire size should be used to reduce the losses in the leads.

Table 1 lists alternate outputs and inputs on the AJ1 and BJ1 connectors. These are parallel to the input main output connectors on these connectors.

4.3 Operation.

The Digimate 1100 amplifier has protective circuits to eliminate transient thumps and spikes during start up and shut down. No special start-up precautions need to be taken. The gain of the amplifier is fixed. It will reach full output with 1.50V on the input with 8 ohm load. Amplification gain control should be located prior to the amplifier. If more than one amplifier is driven, it is important to keep all the inputs properly phased; reversed phasing will reduce the acoustical output although the electrical output is operating at capacity.

Internal electronic circuit monitors assure that the amplifiers always operate in the Safe Operating Area(SOA). If the amplifier currents reach a level which approaches the limit of the SOA, the internal monitors will reduce the gain of the system to prevent exceeding the SOA. This is one of the internal safeguards to assure safe amplifier operation without shutting down the output signal. Thermal rises that approach exceeding the SOA will likewise reduce the operating load and keep the system from entering a failure phase.

The indicating LED's are self explanatory. The power LED's indicate the power on; they will not light if the primary power has been interrupted. The MUTE LED's will come on when the mute switch has been engaged. "SIGNAL ON" LED indicates the circuits are set to pass amplified signals. "OVERLOAD" indicates that the control circuits have reduced the amplifier's current because of the system's exceeding the SOA.

When operating the Digimate 1100, it is desirable to have the load appear as resistive as possible to the output stage. The amplifier will operate into reactive loads, however, it is most efficient in transferring electrical energy into acoustical energy when the loudspeaker system appears resistive.

Each amplifier has a separate "MUTE" switch. It will turn off or on the amplifiers signal path without introducing a thump or transient into the signal path.
fier installations.

4.4 EMERGENCY BYPASS.

If a center channel amplifier should fail, the #1 or #3 OVERLOAD LED will light(you will note the loss of dialog). The system may be operated in mono by inverting the 1100 module, thus using the surround amplifiers to power the center channel. To invert the module, loosen the top and bottom thumb screws, slide the module out of the frame, turn it up-side-down, slide it back in place and tighten the thumb screws. In case of amplifier failure, call your equipment dealer.

DIGIMATE 1100 POWER AMPLIFIER MODULE
CONNECTOR DESIGNATIONS

AJ1

1 OUTPUT + #1
**2 OUTPUT (sense) + #1
3 OUTPUT - #2
4 OUTPUT + #2
**5 OUTPUT (sense) #2
6 OUTPUT - #1
7 GAIN TRIM #1
8 STEERING #1
9 GAIN TRIM #2
10 STEERING #2
11 INPUT - #2
12 INPUT + #2
13 BRIDGE TIE #1
14 BRIDGE TIE #2
15 INPUT + #1
16 INPUT - #1
17 INPUT GND (if required)
*18 INPUT + #1
*19 INPUT - #1

CJ2

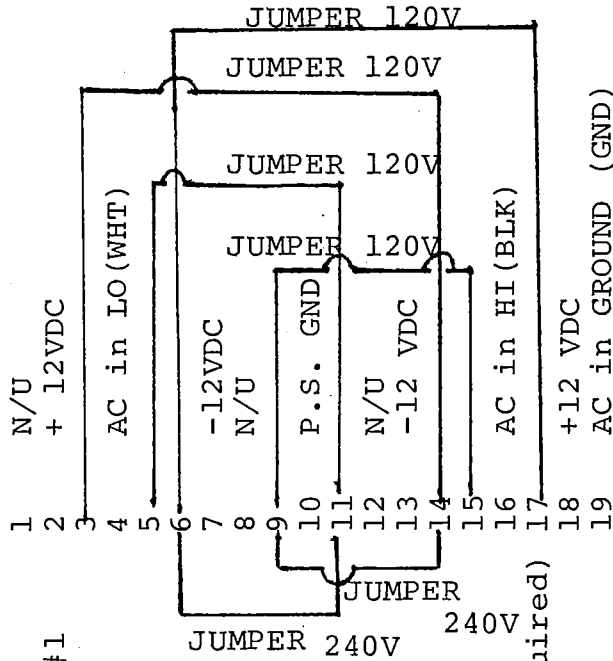

BJ1

1 OUTPUT + #3
**2 OUTPUT (sense) + #3
3 OUTPUT - #4
4 OUTPUT + #4
**5 OUTPUT (sense) #4
6 OUTPUT - #3
7 GAIN TRIM #3
8 STEERING #3
9 GAIN TRIM #4
10 STEERING #4
11 INPUT - #4
12 INPUT + #4
13 BRIDGE TIE #3
14 BRIDGE TIE #4
15 INPUT + #3
16 INPUT - #3
17 INPUT GND (if required)
*18 INPUT + #3
*19 INPUT - #3

*ALTERNATE INPUTS
**ALTERNATE OUTPUTS

RECOMMENDED WIRE SIZES--OUTPUTS: 14 to 16 gauge stranded, INPUTS: 20 to 22 gauge stranded

Chapter 5

KT-1045 MONITOR/EXCITER LAMP SUPPLY

5.1 DC REGULATED EXCITER LAMP SUPPLY(KT-1043).

The exciter lamp power supply can deliver up to six amps of regulated direct current with voltage adjustable from 3.5 to 9.5 volts. It is supplied 110 volts AC through CJ2 pin 4(low), pin 16(high). The output to the exciter lamp is supplied through BJ1 pin 9(ground), pin 10(positive). (refer to schematic, appendix).

On the front panel 3 LED's indicate the output status of the KT-1045: green indicates normal DC output, yellow indicates that the unit has switched itself into emergency status, and red indicates low or no voltage on the output. When the unit has switched to emergency status, the exciter lamp is being powered by 5 volts AC; this would be a result of the loss of the direct current supply. If the current limit of 6 amps is exceeded, the red LED labeled "short" will light.

The current limit has been preset at the factory. The voltage can be adjusted using the potentiometer mounted on the rear of the KT-1045.

5.2 MONITOR--adjusting the level indicators.

Turn ON the power amplifiers. The Monitor Level Trim Controls are located on the rear panel on the module; from the top the trim controls are:

- Surround Left
- Surround Right
- Low Frequency
- Center Hi Frequency
- Center Low Frequency
- Center Combined

First adjust the Center Hi Frequency. Push the monitor select switch until the Center Hi Frequency LED lights up. The Monitor Select switch is such that on push changes the setting one increment. Adjust the CENTER Hi Frequency trim until the "-24" LED Level Indicator is lit. Switch the monitor to center Low Frequency and repeat the trim procedure. Switch the monitor to center combined and trim center combined. Repeat the procedure for the remainder of the trim pots. The monitor select switch automatically returns to the center combined position after a time. If while setting the trims you are interrupted when you return be sure the monitor select is still in the position that you selected.

5.3 LOCATION OF FUSES.

5.3.1 EXCITER SUPPLY.

There are two fuses mounted in clips at the top edge of the circuit board inside the module.

2 AMP, 250 volt slowblow--located to the rear of the unit in the primary coil of the input transformer.

10 AMP slowblow--located closer to the panel between the transformer secondary and the DC rectifier.(Removal of this fuse will result in the unit switching itself to AC operation).

There is a third fuse:

10 AMP, slowblow--located just forward of the PC card in the emergency AC feed.

5.3.2 MONITOR.

1/4 AMP, slow blow--located against the rear panel of module next to the dip switch.

Chapter 6

SET UP PROCEDURE WHEN INSTALLING NEW SOLAR CELLS IN PROJECTOR.

Each unit is carefully adjusted at the factory to the levels that occur in the majority of today's movie theatres. Thus, the system should perform satisfactorily with only the preamplifier adjustment necessary. What follows is the fine tuning procedure which requires:

- Test Film
- Real Time Analyzer
- Sound Pressure Level Meter
- Dual Trace Oscilloscope

A Chain Alignment. (Summary)

The A Chain refers to all elements up to and including the preamp. This includes setting gain, balance, and frequency response. First the task is to install the split (stereo) solar cell. This involves adjusting the positions of the exciter lamp, the slit, the film path, and the solar cell. The center of the evenly illuminated slit should line up with the center of the film track, then be projected onto the center of the solar cell. The Buzz track sets the slit to track position. The preamp balance indicator aids in the adjustment of the exciter lamp and solar cell position. The left/right test film aids in the final positioning of the solar cell for balance and separation. The Pink Noise film and optionally the Azimuth test film set focus and azimuth of the slit. These adjustments may interact with one another, so it is necessary to recheck the adjustments made previously.

For playing stereo film the slit optics must be narrower than 1 mil or (.0254mm) check with the projector manufacturer.

6.1 Step 1: Set the exciter lamp voltage to 80% rated lamp voltage. To prolong their usefulness and minimize filament sag. Make sure the slit optics are clean and not fogged. View the projected slit by holding a piece of white paper beyond the film plane. Focus the filament and see that the filament is centered horizontally and vertically. Adjust the exciter lamp mount until it is. Clean and inspect the solar cell for cracks or breaks it will not balance if damaged.

6.1 Step 2: Connect the Solar Cell to the preamp. Put the solar cell bracket roughly in place. Position the bracket until the surface of the cell is 1mm from the film plane surface. Further away, there will be crosstalk between the two optical stereo tracks. Check the image of the slit on the cell. The image should be a thin sharp line. The slit image length should be nearly as wide as, and centered on the cell, and positioned at three-quarters of the height of the cell. Try to get the best compromise among all of these conditions and then tighten the cell bracket.

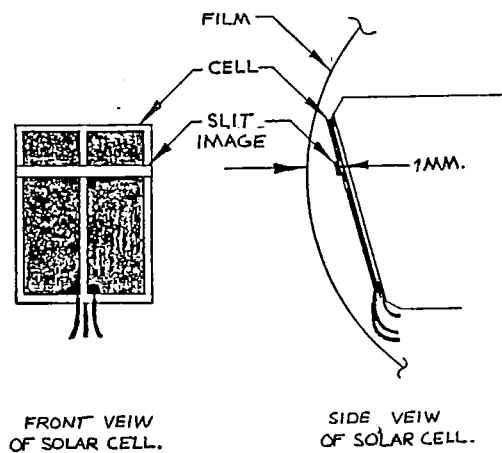

Fig. 12
Placement of Solar Cell

6.2 Step 1: Turn on the power, and select projector mode, adjust cal pot until the cal LED lights up. Set the Balance potentiometer in the physical center of its travel (12 o'clock) before adjusting the projector optics. Note: make sure the stereo mono switch is in stereo.

6.2 Step 2: Move the cell until the bal. LED lights the brightest. Alternatively: use the dual trace scope to balance D.C. Voltage out of the cells directly. or a microampmeter measuring current across the two cells (when balanced no current flows either way).

6.2 Step 3: Connect a dual trace scope to the preamp test points. Run SMPTE Buzz Track and adjust the lateral guide roller until minimum or no modulation is detected from either trace. If minimum modulation, both sides should be equal. This assures that the slit is illuminating only the track area and is centered on the center line of the track.

6.3 Step 1: Next focus and set azimuth of the slit: Connect the spectrum analyzer to Test point one of the preamplifiers and place a loop of pink-noise film in the appropriate projector. Important: the emulsion should be facing away from the screen as it runs through the projector.

Loosen the clamp so the slit lens moves freely. Run the pink-noise loop. While observing the display on the analyzer, focus the slit lens by moving it in and out to obtain the maximum level of high frequencies. Adjust the lens azimuth with slight back-and forth turns to gain the best high-frequency response.

6.4 Step 1: Connect a dual trace oscilloscope, set in the XY mode, to the left and right preamplifier test points TP3 and TP4 in the processor. Make fine adjustment of the slit lens focus while observing the oscilloscope trace for the azimuth adjustment. Adjust for the straightest 45 degree line possible. Tighten the clamp only enough to hold the slit lens in place. Over tightening distorts lens elements.

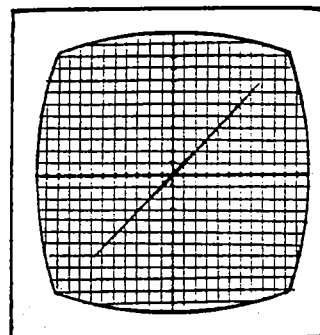
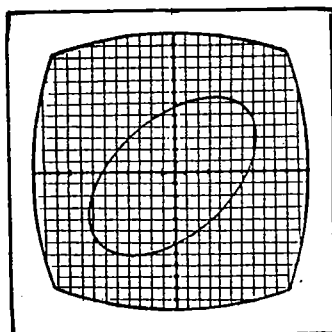

Fig. 14

Wrong

Correct

Azimuth Adjustment on X/Y Oscilloscope

6.5 Step 1: Remove the pink-noise loop and replace it with a left-right cell adjustment film loop such as Dolby Cat. 97.

Place the scope in the dual-trace mode and run the film. Loosen the cell and adjust the lateral position of the cell for a minimum of cross talk, and an equal amount of signal in both tracks

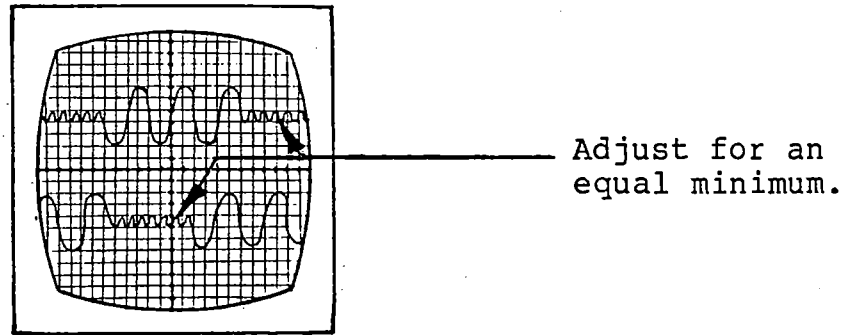

Fig. 15 Left/Right Film on Dual Trace Oscilloscope

6.5 Step 2: Check to see if the left and right cells are properly connected to their left and right preamplifiers by inserting a business card in front of the slit lens. The right channel should drop first. Correct if necessary.

6.5 Step 3: Remove the left/right film from the projector with the slit illuminating the solar cell retrim the calibration, and set the trim on the balance until the balance LED is brightest. It should be near the center of its range (slot pointing straight up). Modulation from the left and right tracks should be equal when the open illumination of the solar cell is balanced. If it is not, the light source is uneven or the track modulation is not lined up with the solar cell. This could cause clipping.

6.6 Step 1: Lace up and roll the pink-noise loop (emulsion facing away from screen) connect the real time analyzer to the test point for left and ground. Adjust the slit loss correction pot for flattest line possible to 10kHz. Repeat for the right. If the pot position required for each side is very different inspect for oil or dirt on the slit lense or a defective exciter lamp, causing one sides high frequency response to be different from the other side.

If slightly different make a compromise setting of the slit loss correction pot.

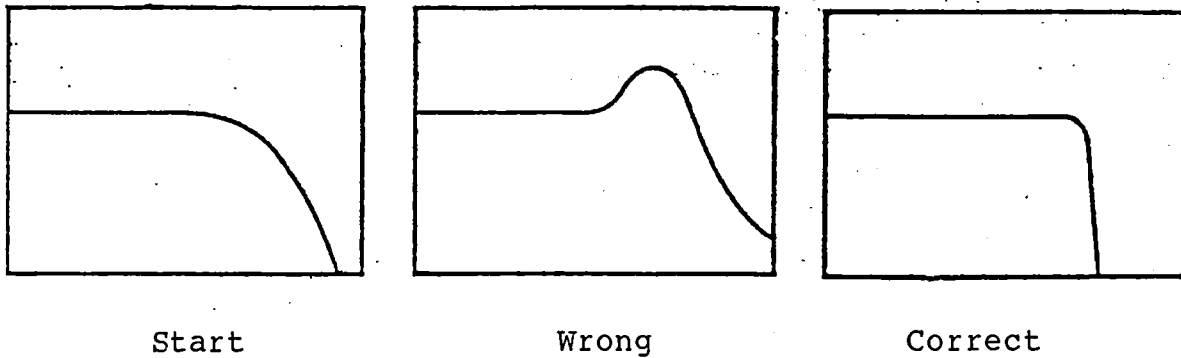
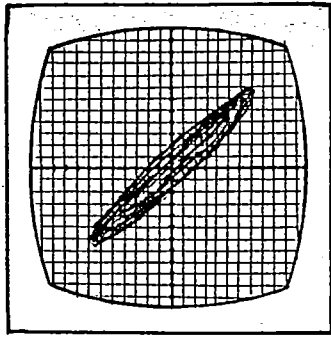
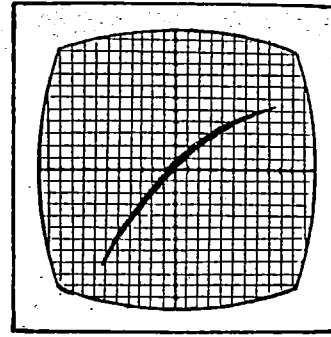

Fig. 16 Slit loss adjustment shown on real time analyzer



Azimuth Out
Of Adjustment.



Uneven Light
Both Channels.

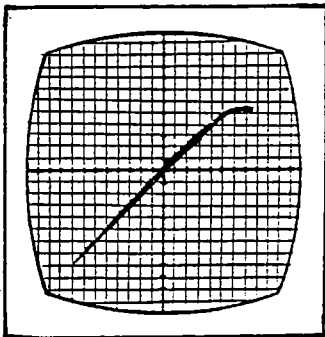

Uneven Light
One Channel.

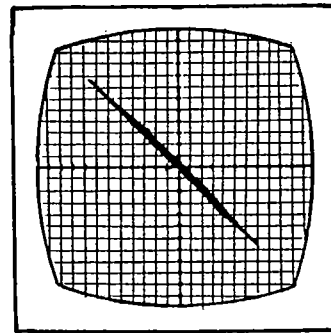

One Channel
Phase Reversed.

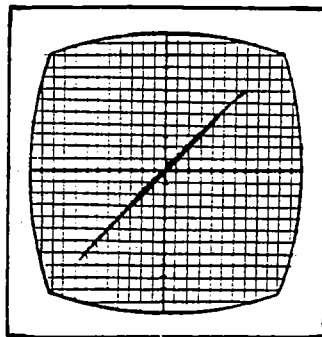

Correct



Buzz Track

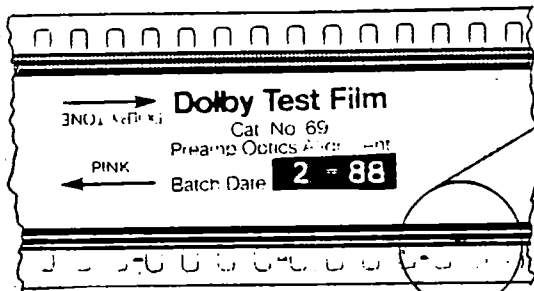

Pink Noise

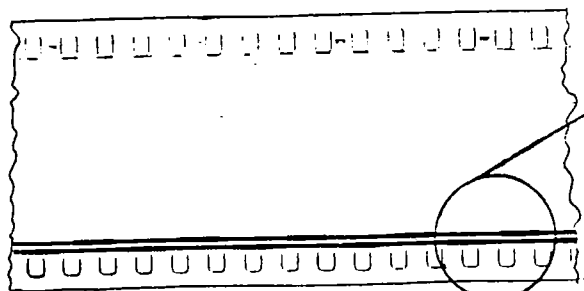

Left/Right Test Film