

# Film-Tech

The information contained in this Adobe Acrobat pdf file is provided at your own risk and good judgment.

These manuals are designed to facilitate the exchange of information related to cinema projection and film handling, with no warranties nor obligations from the authors, for qualified field service engineers.

If you are not a qualified technician, please make no adjustments to anything you may read about in these Adobe manual downloads.

[www.film-tech.com](http://www.film-tech.com)

*Holmes...*

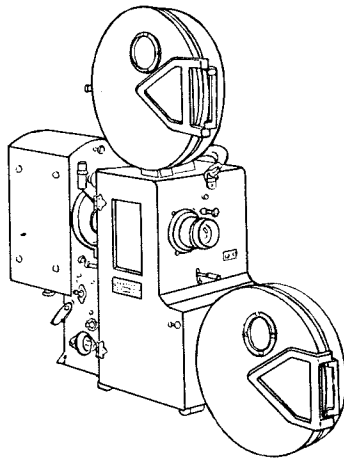

means *...nothing finer!*

# HOLMES

*Ball Bearing Sound on Film Projector, less  
Amplifier, Tubes, Speaker and Speaker Cable*

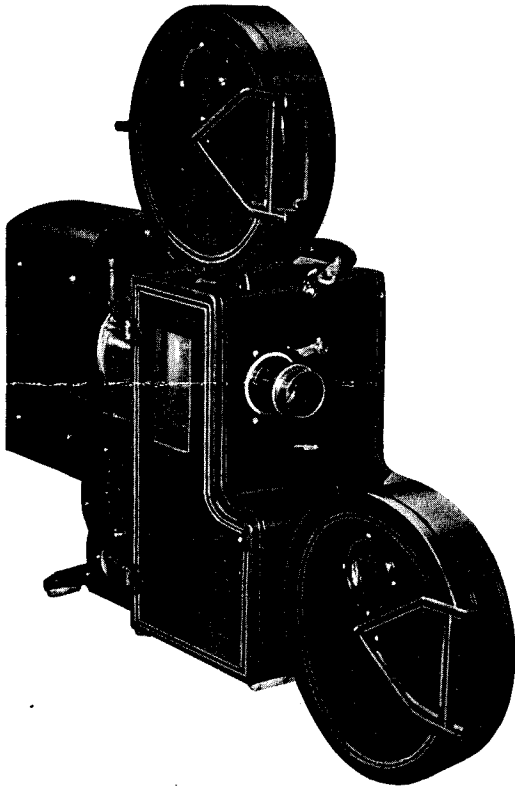

- 1 — HOLMES Ball Bearing Sound on Film Projector with 2000' Magazines, Governor or Constant Speed Motor
- 1 — 1000 Watt 115 Volt Prefocus Base Lamp
- 1 — Motion Picture Lens
- 1 — Empty Reel
- 1 — Oil Can
- 1 — Projector Cord
- 1 — Photo Electric Cell
- 1 — P.E. Shielded Wire Connection
- 1 — Exciter Lamp Cord with Connection
- 1 — Built-In Pilot Light

Code Word — SINPO

Price \$690.00

Illustrated below is the HOLMES single equipment with L25N Amplifier and 12 inch Permanent Magnet Speaker. The amplifier has a power output of 25 watts, which will cover auditoriums of 800 seats and up. The speaker furnished with the L25N amplifier is manufactured by one of the leading speaker manufacturers in the country especially for the above amplifier. It is very compact, efficient, and of the highest quality.

- 1 — HOLMES Ball Bearing Sound on Film Projector with 2000' Magazines, Governor or Constant Speed Motor
- 1 — 1000 Watt 115 Volt Prefocus Base Lamp
- 1 — Motion Picture Lens
- 1 — Empty Reel
- 1 — Oil Can
- 1 — Projector Cord
- 1 — Photo Electric Cell
- 1 — P.E. Shielded Wire Connection
- 1 — Exciter Lamp Cord with Connection
- 1 — Threading Lamp
- 1 — Framing Lamp
- 1 — L25N Amplifier with Tubes
- 1 — P12N Speaker in Case
- 1 — 100' Speaker Cable with Connection

Code Word — SIPRO

Price \$986.25

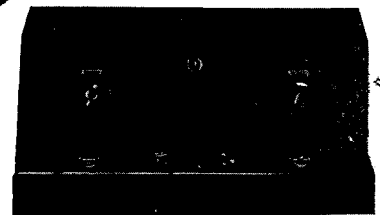
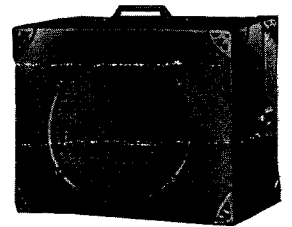
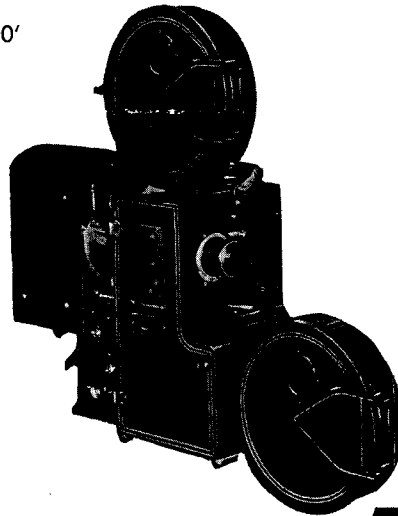

# *A* **HOLMES** *is always better*

The wonderful illumination obtained from a HOLMES is directly traceable to the high grade optical system and large reflector. It is common practice for HOLMES owners to project a 9x12 foot picture.

The 1000 watt 115 volt prefocus base mazda projection lamp is supplied as standard equipment. Projection lamps of lower or higher wattages can be used without any change in the lamphouse.

The HOLMES projectors illustrated have 16 inch magazines, which take the same standard 2000 foot reels of 35mm. film that are used in all theatres.

The amplifier has an output capacity of 25 watts which will cover large auditoriums. The tube complement consists of one 6J7, two 6C5, two 6L6G and one 5U4G tubes.

Input receptacles for one or two machines.

Volume control. Changeover switch.

Continuously variable built-in tone control.

Receptacle for electric turntable.

Microphone receptacle.

Output impedance for speaker 8 or 16 ohms.

Operating voltage 115 A.C. 50 or 60 cycles.

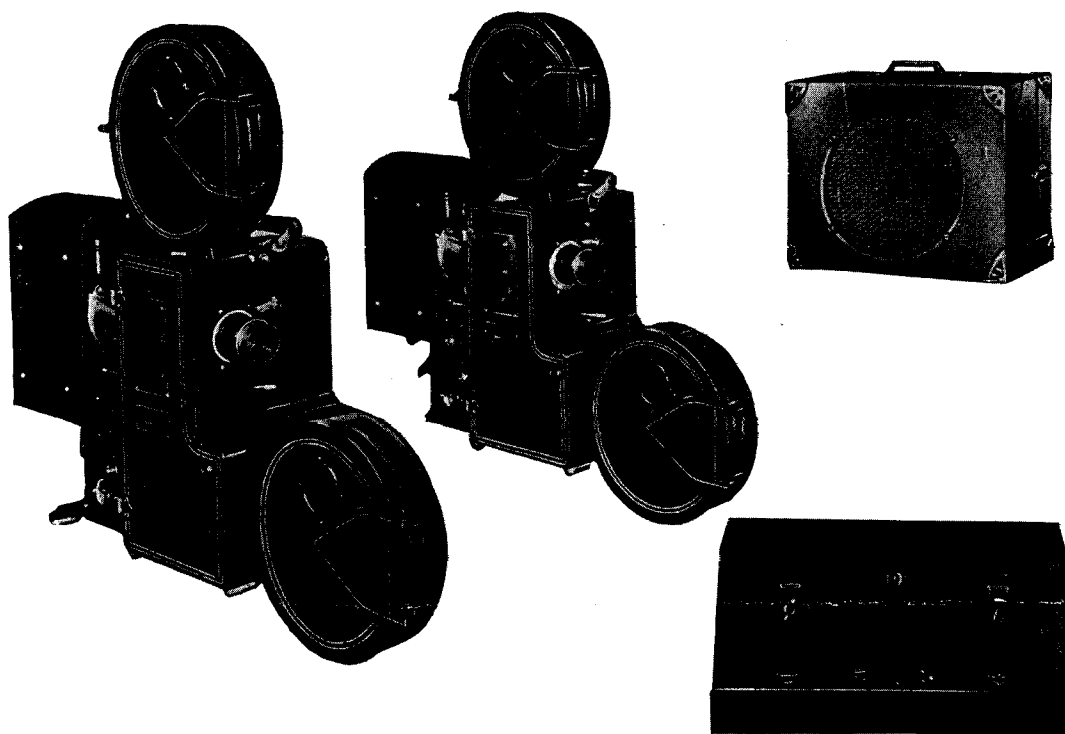

2 — HOLMES Ball Bearing Sound on Film Projectors with 2000' Magazines, Governor or Constant Speed Motors

2 — 1000 Watt 115 Volt Prefocus Base Lamps

2 — Motion Picture Lenses

2 — Empty Reels

1 — Oil Can

2 — Projector Cords

2 — Photo Electric Cells

2 — P.E. Shielded Wire Connections

2 — Exciter Lamp Cords with Connections

2 — Threading Lamps

2 — Framing Lamps

1 — L25N Fidelity Amplifier with Tubes

1 — P12N Speaker in Case

1 — 100' Speaker Cable with Connections

**Price \$1,676.25**

**Code Word — DUPRO**

# The **HOLMES** Invites Comparison

## ARC EQUIPPED HOLMES

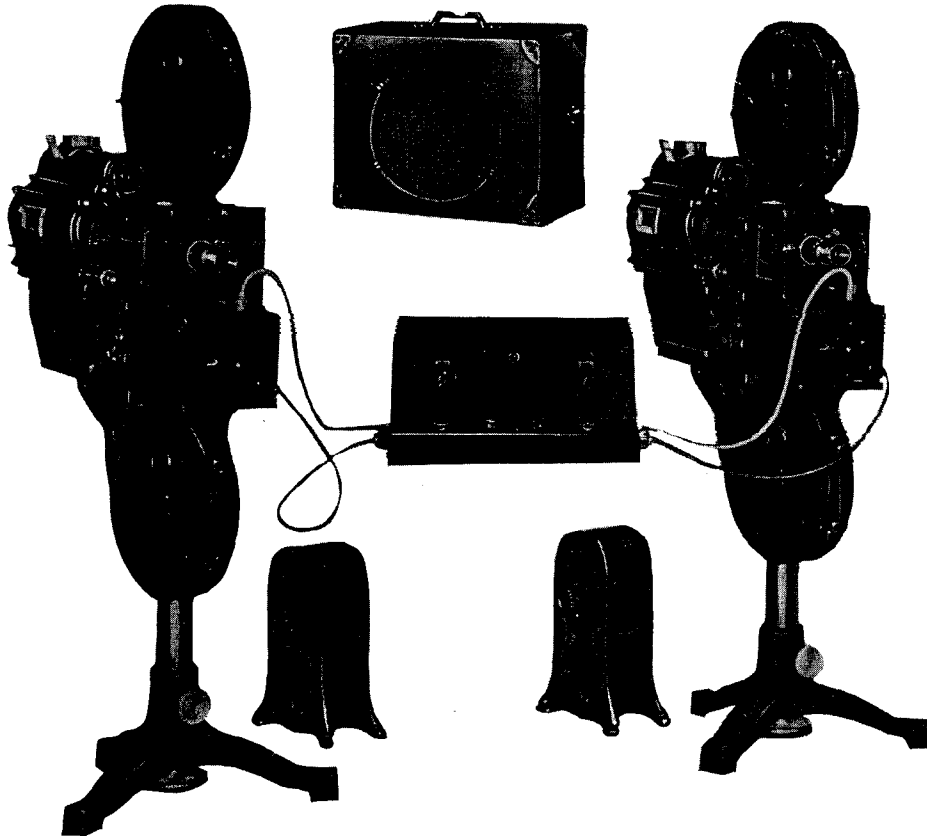

- 2 — HOLMES Ball Bearing Sound on Film Projectors with 2000' Under-slung Lower Magazines
- 2 — Motion Picture Lenses — Series I
- 2 — 3-Point Pedestals with Arc Lamp Brackets
- 2 — Empty Reels
- 1 — Oil Can
- 2 — Projector Cords
- 2 — Photo Electric Cells
- 2 — P.E. Shielded Wire Connections
- 2 — Exciter Lamp Cords with Connections
- 2 — Threading Lamps
- 2 — Framing Lamps
- 1 — L25N Fidelity Amplifier with Tubes

(Price Less Speaker, Arc Lamps, Rectifiers and Tungar Bulbs)

**Code Word — ARCPO**

**Price \$1760.00**

### SPEAKERS

Due to the many different sizes and shapes of auditoriums and theatres we have listed and priced the various types of speakers individually. This makes it possible to select the correct type speaker.

1 — P12N Speaker in Case with 100' Speaker Cable

**Code Word CASPE**

**PRICE.....\$86.25**

The above speaker with 100' Speaker Cable and Baffle Board

**Code Word BAFLE**

**Price Same as Above**

1 — Coaxial Speaker in Base Reflex Cabinet

**Code Word REFLE**

**PRICE.....\$250.00**

1 — EP-801 Two-Way Speaker System

**Code Word CABIT**

**PRICE.....\$556.70**

1 — P.M. Booth Monitor Speaker

**Code Word NAZBE**

**PRICE.....\$30.50**

For prices of Arc Lamps, Rectifiers and Tungar Bulbs, see separate price sheet enclosed.

# *Quality sells it, economically priced*

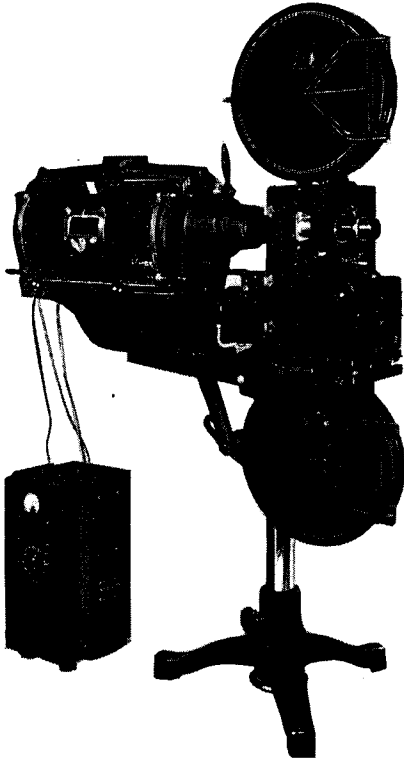

- 2 — HOLMES Ball Bearing Sound on Film Projectors with 2000' Underslung Lower Magazines
  - 2 — Cast Aluminum Shutter Guards with Baffles
  - 2 — Motion Picture Lenses — Series I
  - 2 — 3-Point Pedestals with Arc Lamp Switches
  - 2 — Empty Reels
  - 1 — Oil Can
  - 2 — Projector Cords
  - 2 — Photo Electric Cells
  - 2 — P. E. Shielded Wire Connections
  - 2 — Exciter Lamp Cords with Connections
  - 2 — Threading Lamps
  - 2 — Framing Lamps
  - 1 — L25N Fidelity Amplifier with Tubes
- (Price Less Speaker, Arc Lamps, Rectifiers and Tungar Bulbs)

**Code Word — HIPOR**

**Price \$1779.00**

## **SPEAKERS**

Due to the many different sizes and shapes of auditoriums and theatres we have listed and priced the various types of speakers individually. This makes it possible to select the correct type speaker.

1 — P12N Speaker in Case with 100' Speaker Cable

**Code Word CASPE**

**PRICE.....\$86.25**

The above speaker with 100' Speaker Cable and Baffle Board

**Code Word BAFLE**

**Price Same as Above**

1 — Coaxial Speaker in Base Reflex Cabinet

**Code Word REFLE**

**PRICE.....\$250.00**

1 — EP-801 Two-Way Speaker System

**Code Word CABIT**

**PRICE.....\$556.70**

1 — P.M. Booth Monitor Speaker

**Code Word NAZBE**

**PRICE.....\$30.50**

For prices of Arc Lamps, Rectifiers and Tungar Bulbs, see separate price sheet enclosed.

# TIME TRIED, TIME TESTED and TIME PROVEN

## THE HOLMES PROFESSIONAL

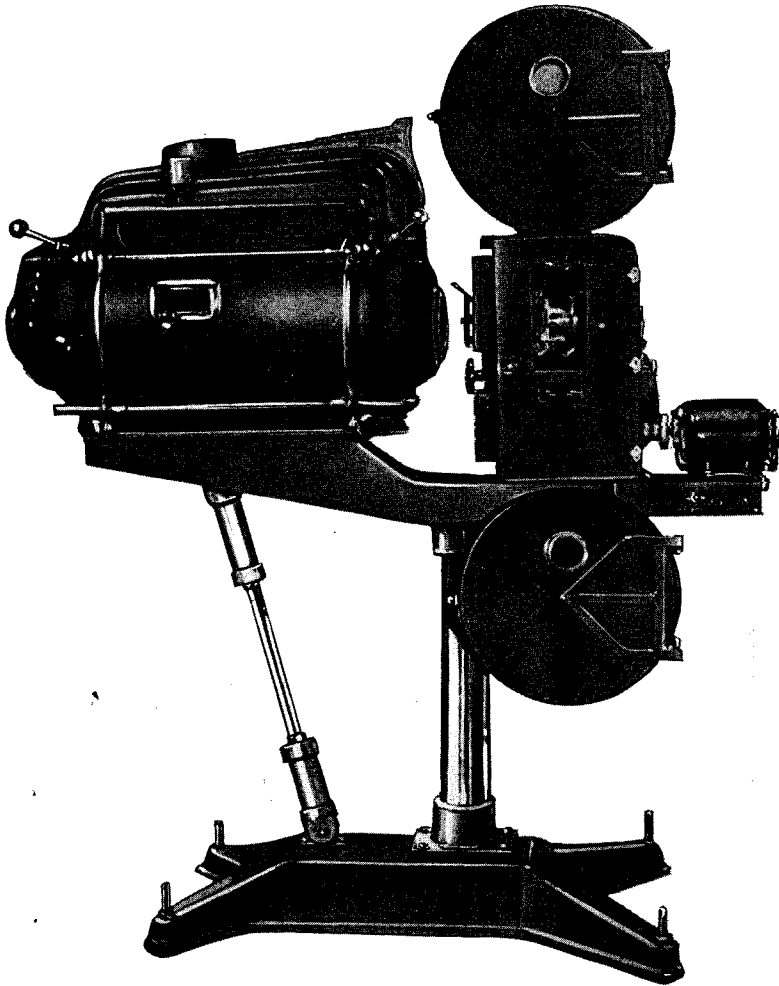

- 2 — HOLMES Professional Type GP Projectors with Integral Sound Units
- 2 — Type T-4 Point Pedestals
- 2 — 115 Volt 60 Cycle Motors
- 2 — Upper 2000' Magazines
- 2 — Lower 2000' Magazines
- 2 — Arc Lamp Switches
- 2 — P.E. Cell Cables 5' Long
- 2 — Exciter Lamp Cords 5' Long
- 2 — Empty Reels
- 1 — Oil Can

Code Word — PROFO

Price \$2125.20

Series I Lenses 3 to 6" Focus	\$37.50 ea.
Series II Lenses, coated f/2.0	
3-1/2 through 5" Focus	100.00 ea.
5-1/4 through 7" Focus	120.00 ea.

### AMPLIFIER

L25N Amplifier with Tubes	\$210.00 ea.
2 — Electric Changeovers with Foot Switches	\$150.00 (Per Pair)

### SPEAKERS

Due to the many different sizes and shapes of auditoriums and theatres we have listed and priced the various types of speakers individually. This makes it possible to select the correct type speaker.

- 1 — P12N Speaker in Case with 100' Speaker Cable  
    Code Word CASPE

PRICE.....\$86.25

- The above speaker with 100' Speaker Cable and Baffle Board  
    Code Word BAFLE

Price Same as Above

- 1 — Coaxial Speaker in Base Reflex Cabinet  
    Code Word REFLE

PRICE.....\$250.00

- 1 — EP-801 Two-Way Speaker System  
    Code Word CABIT

PRICE.....\$556.70

- 1 — P.M. Booth Monitor Speaker  
    Code Word NAZBE

PRICE.....\$30.50

For prices of Arc Lamps, Rectifiers and Tungar Bulbs, see separate price sheet enclosed.

# The HOLMES DRIVE-IN THEATRE EQUIPMENT

The Holmes Type GP Professional Projector, illustrated below, is equipped with Mogul High Intensity Lamp, drawing 70 Amperes, using a 6-tube, 220-volt Rectifier. This same machine will accommodate the Utility 46-Ampere Lamp, also the Utility One-KW High Intensity Lamp.

The types of Rectifiers required for the above lamps will depend upon the size of the picture. Write for full details.

## D1A CABINET TYPE AMPLIFIER

The D1A amplifier incorporates in one cabinet the following units:

- 3 — 40 watt power amplifiers
- 1 — 12 circuit ramp switching panel
- 1 — A. C. exciter lamp supply
- 1 — Changeover relay
- 1 — Ramp circuit terminal compartment

This construction permits factory interconnecting of all components except head amplifiers and monitor speaker thus making installation an extremely simple procedure as well as reducing the possibility of wiring errors.

## FRAMING

The intermittent unit frames on the sprocket center. This is accomplished by a rack and pinion, which makes framing easy and accurate.

The framing rod with large hand wheel extends through the back of the projector, and can be conveniently operated from either side of the machine.

## CHANGEOVER RELAY

Changeovers are made instantly and silently by means of a heavy duty relay mounted in the main amplifier and operated by push button switches in the head amplifiers.

## HEAD AMPLIFIERS

Each of the head or pre-amplifiers contains three stages of voltage amplification.

A volume control, changeover switch, and pilot light are mounted in the front of the cabinet.

The output of the two projectors can be equalized by means of an adjustment in each head amplifier.

## MONITOR SPEAKER

The monitor speaker with its input transformer and volume control are mounted in a metal case provided with mounting brackets which permit the entire unit to be tilted at any angle.

## INTERMITTENT

There are no gears in the intermittent housing to wear. The flywheel is rigidly mounted on the cam shaft. The shutter automatically sets itself by a patented cam action.

The intermittent unit is hardened and ground, and runs in a grease bath. Refilling the intermittent with grease is just a matter of removing one screw and squeezing a grease tube.

## REAR SHUTTER

The picture shutter is mounted between the projector mechanism and lamphouse and is entirely enclosed in a separate housing when all the mechanism-enclosing walls are on the head.

For the past 18 years Holmes Projectors have had rear shutters, and the Holmes was the first machine ever built with a rear shutter.

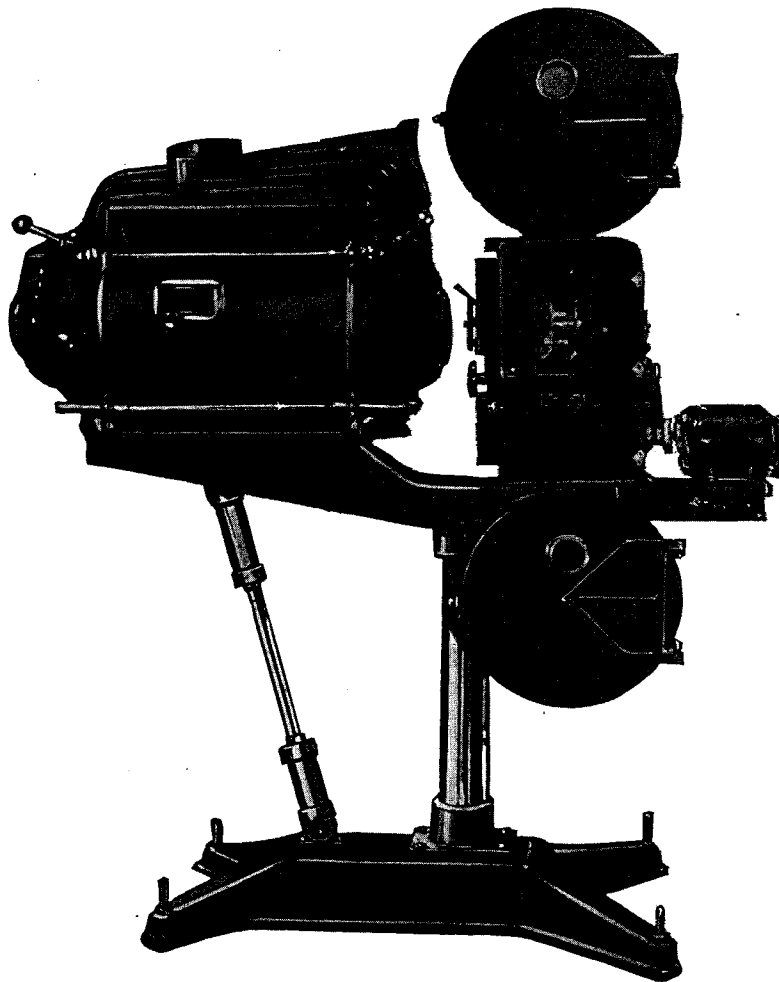



### RAMP PANEL

The ramp panel is provided with an individual switch for isolating each of the 12 separate ramp circuits. Adjustable heavy duty resistors which can be set at the time of installation to match the impedance of each ramp circuit are provided to maintain a constant load on the power amplifier should trouble develop in any of the ramp lines.

### RAMP CIRCUIT CONNECTIONS

The ramp lines are brought into a compartment in the bottom of the D1A. A heavy duty block with a sturdy terminal for each wire simplifies the operation of connecting the ramp lines to the amplifier.

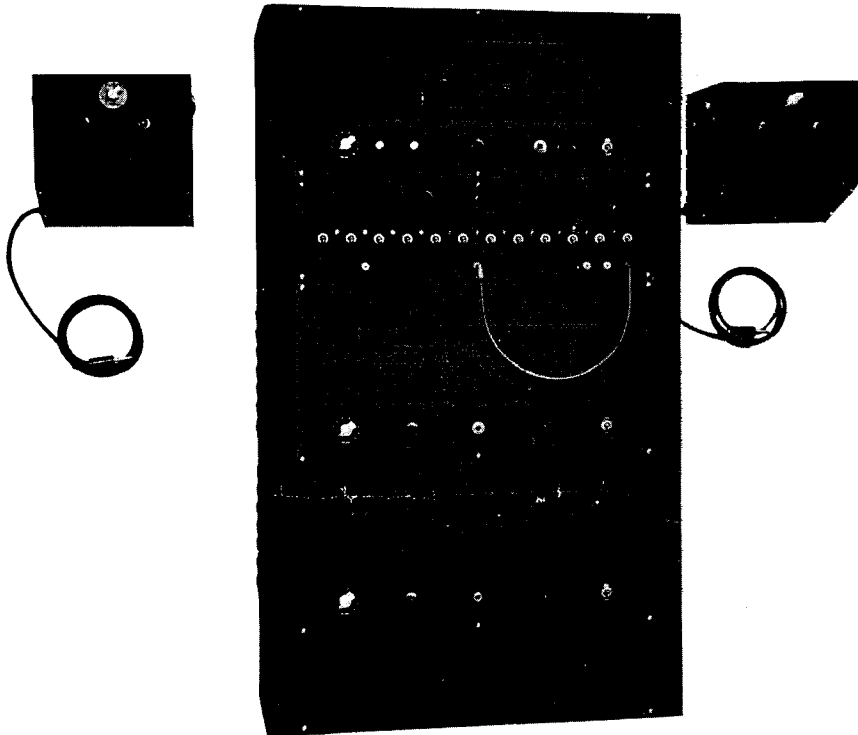

### SPECIFICATIONS OF FIDELITY D1A DRIVE-IN THEATRE AMPLIFIER

Output	120 watts
Noise Level	-55db below output
Output impedance (each 40 watt unit)	8, 16, 32, 64 and 128 ohms
Dimensions: Height	42½"
Width	24¾"
Depth	11¾"
Weight	185 lbs.
Tube Complement: (each power unit)	1 6V6GT 2 807 1 5U4G
(each head amplifier)	1 6J7 2 6J5

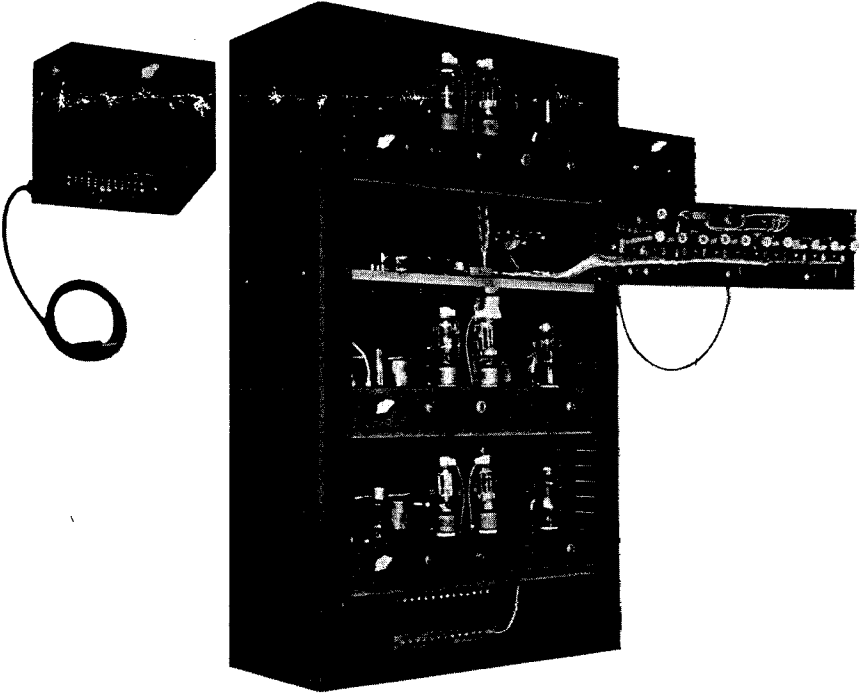

# PROJECTOR STAND

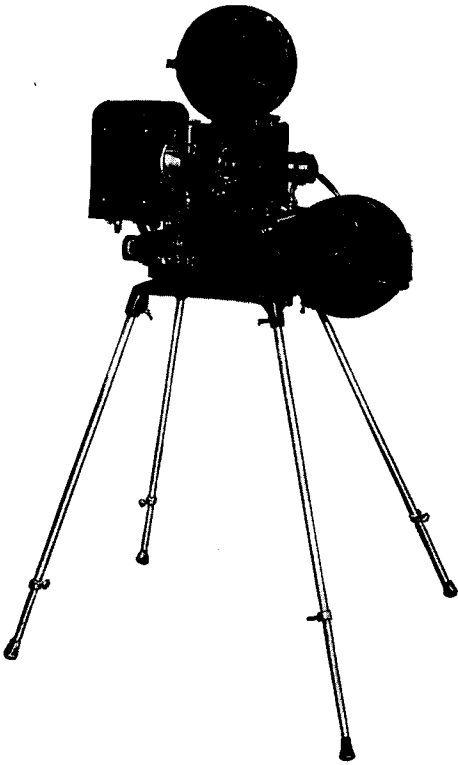

The illustration at the left shows the Holmes mounted on a 4 legged stand.

The stand consists of a platform with brackets underneath for holding the amplifier. The four telescoping legs permit the machine to be raised or lowered to any convenient height for the operator. Tilting the stand in either a downward or upward position is accomplished by loosening the thumb screws on the legs and setting the table at the angle required. The HOLMES when placed on the stand is held in position by two large thumb screws.

Due to its light weight and sturdy construction this stand is very practical for either permanent or portable uses.



Projector Stand  
Code Word — PORSA  
Price \$46.00

## THREE POINT PEDESTALS

Illustrations below show the table top pedestals with and without arc lamp brackets

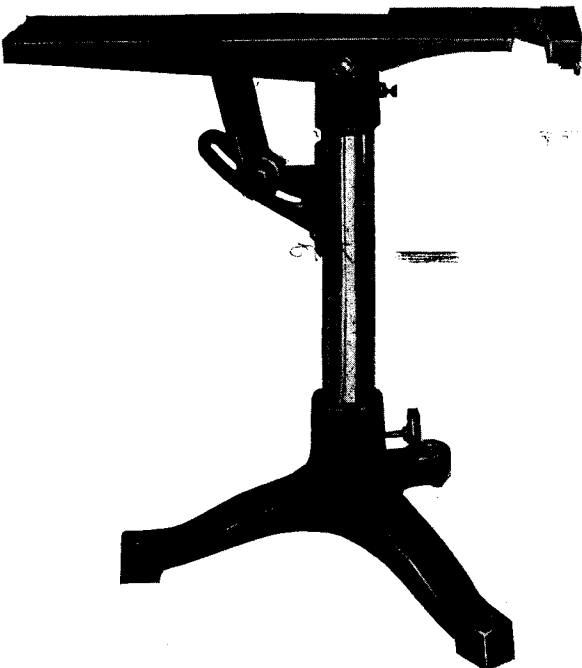

Price \$81.00  
Code Word — TATRI

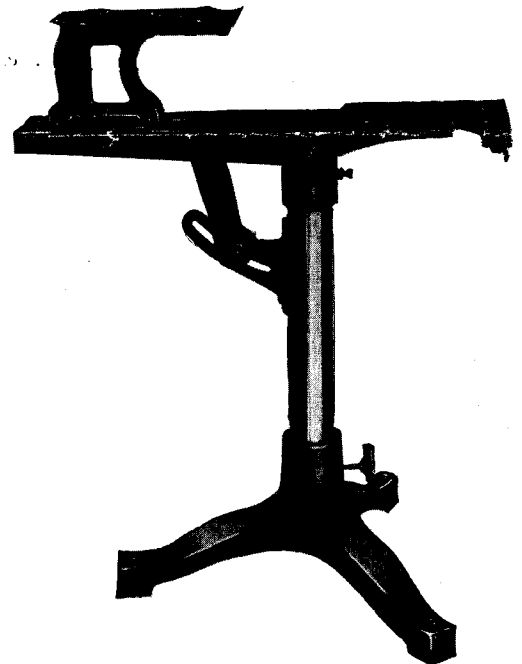

Price \$110.00  
Code Word — TABRA

# AMPLIFIER

## MODEL L-25-N

This amplifier has an output capacity of 25 watts which will cover auditoriums up to 2,000 seats. The tube complement consists of 1 - 6J7, 2 - 6C5, 2 - 6L6G, 1 - 5U4G.

- Input receptacles for one or two machines.
- Volume control. Changeover switch.
- Continuously variable built-in tone control.
- Receptacles for electric turntable.
- Receptacle for carbon or crystal microphones.
- Output impedance for speaker 8 or 16 ohms.
- Operating voltage 115 A.C., 50 or 60 cycles.

Code Word — AMLES

Price \$210.00

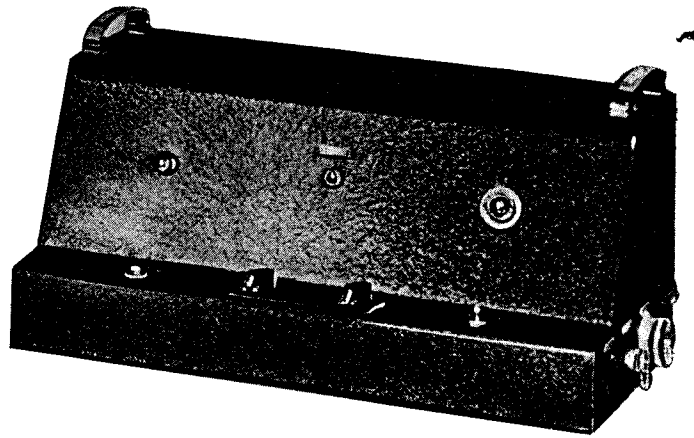

## MICROPHONE

This is a new type of crystal diaphragm microphone with a swiveled head permitting its use as a directional or non-directional unit. Frequency response is flat (plus or minus 5 db) from 30 to 10,000 cycles. The microphone is furnished with handle and 25 feet of cord with plug.

Microphone with handle, plug and 25 foot cord.

Code Word — CIGOS

Price \$35.65

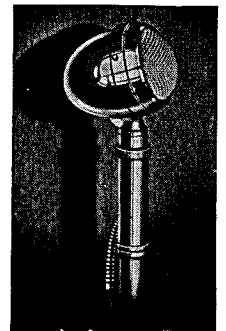

## MONITOR SPEAKER

The illustration at the right shows a booth Monitor Speaker mounted in a metal case, complete with potentiometer, cord and plug for plugging into the amplifier. The L25N Amplifier has a receptacle for plugging in Monitor Speaker.

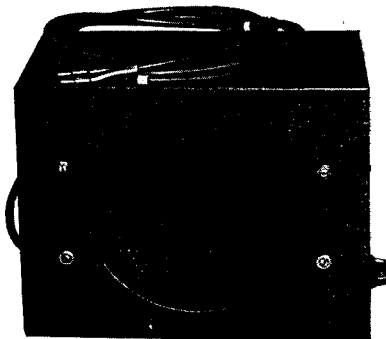

Monitor Speaker in metal case with potentiometer, 12 foot cord and plug.

Code Word — NAZBE

Price \$30.50

## MOTION PICTURE LENSES

Series 1 Motion Picture Lens without Jacket in any focal length from 3 to 10 inches.

Code Word — MOPIC

Price ~~\$22.00~~ 37.50

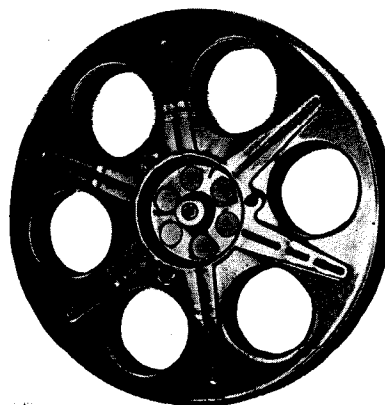

## REEL

Standard 2000 ft.

Steel Reel.

Code Word — REEL

Price \$2.30

# SPEAKERS

## CORRECT SPEAKERS

Selecting speaker equipment for an auditorium requires a certain type of speaker to get proper sound distribution throughout. Wide auditoriums often require two or more speakers to get equal sound distribution throughout. In order to obtain the type of speaker or speakers best suited for your auditorium, we suggest that all dimensions along with the distance of projection be sent to us. With the above information, we can then recommend the correct speaker equipment.

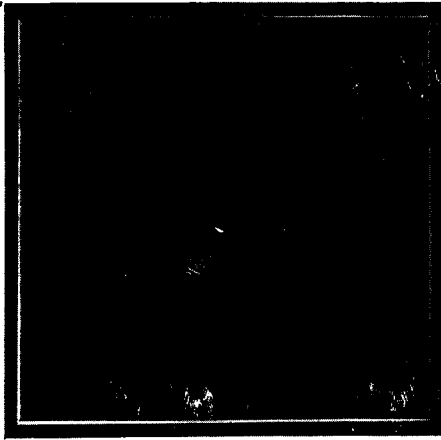

**P12N PM SPEAKER WITH BAFFLE**  
Code Word — BAFLE  
Price \$86.25

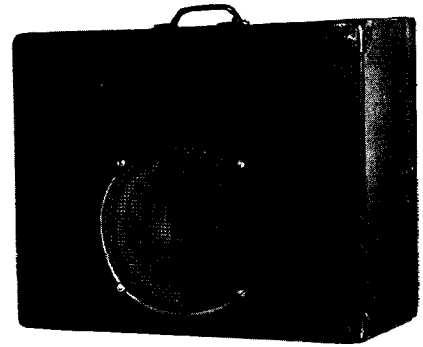

**P12N PM SPEAKER IN CASE**  
Code Word — CASPE  
Price \$86.25

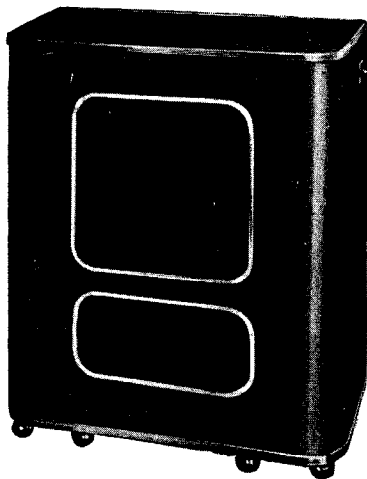

## BASE REFLEX SPEAKER

The speaker used in this system is of the coaxial type, entirely new in design. It is coaxially assembled into a compact unit with a built-in frequency dividing network having a crossover at 1800 CPS. High frequencies are reproduced by a new compression type high frequency speaker, and the low frequencies by a 15-inch low frequency speaker. Both are powered by Alnico 5 permanent magnets.

Minimum distortion and unusually good polar distribution is obtained.

The speaker is mounted in a base reflex cabinet which is highly recommended for theatres.

Code Word — REFLE  
Price ████████ \$250.00

## CABINET TYPE TWO-WAY REPRODUCER

The cabinet type two-way reproducer consists of a special type multi-cellular horn and a high frequency speaker unit with a small but very rugged diaphragm of new design. The 18-inch low frequency speaker and the high frequency speaker are both of the permanent magnet type.

The cabinet is equipped with an 800-cycle dividing network that provides high and low frequency separation. Each unit is equipped with an attenuator permitting balancing of the high and low frequency response.

Angle of distribution is 100 to 120 degrees horizontal and 60 degrees vertical.

For auditoriums or theatres up to 1,500 seats.

Code Word — CABIT  
Price ████████ \$556.70

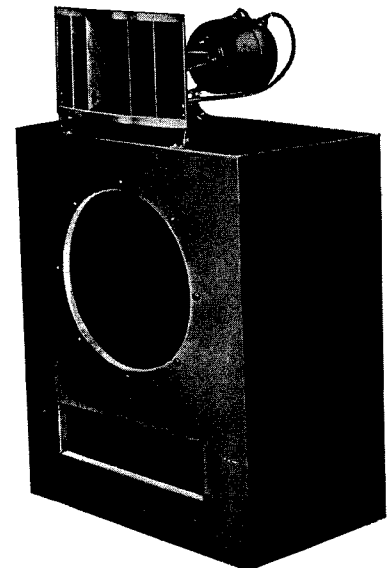

# SPARE UNITS, PARTS AND ACCESSORY PRICE LIST

Type L25N Amplifier with Tubes, Speaker in Case, 100 Foot Speaker Cable	Code Word — AMTHI	Price \$296.25
Type L25N Amplifier with Tubes, without Speaker Case or Speaker Cable	Code Word — AMLES	Price \$210.00
Amplifier Fuses.	Code Word — FUSES	Price \$ .12
Complete Set of Tubes for Type L25N Amplifier.	Code Word — THUBE	Price \$ 12.60
Extra Long 5' P. E. Cell Cable with Plugs.	Code Word — POBLE	Price \$ 5.75
Extra Long 5' Exciter Lamp Cord with Plugs.	Code Word — EXCAB	Price \$ 3.75
Photo Electric Cell. RCA 1P30	Code Word — PHOEL	Price \$ 9.00
Exciter Lamp. 4A/T8/25 BXC 8½ v, 4 amp	Code Word — EXLAM	Price \$ .60

## Extra Speaker Cable with Connections for Type L25N Amplifier

1— 50 foot with plugs.	Code Word — NIJEC	Price \$ 11.50
1—100 foot with plugs.	Code Word — NYCHE	Price \$ 17.50
1—150 foot with plugs.	Code Word — NUSTA	Price \$ 23.50

## EXTRA MAZDA LAMPS

1000 Watt 115 Volt Mogul Prefocus Base Lamp (For Machines with Serial No. 9500 to 18416)	DSB 25 hrs.	Code Word — UMOPT	Price \$6.25 Net
1000 Watt 115 Volt Medium Prefocus Base Lamp (For Machines with Serial No. 18417 and up)	DFD 10 hrs.	Code Word — MEPRE	Price \$4.50 Net
1500 Watt 115 Volt Mogul Prefocus Base Lamp (For Machines with Serial No. 9500 to 18416)	DTJ 25 hrs.	Code Word — UOLRW	Price \$9.75 Net

## HAND REWINDS

Fully enclosed geared hand rewinds to take 10 or 15 inch reels.

Code Word — HANRE  
Price \$10.00

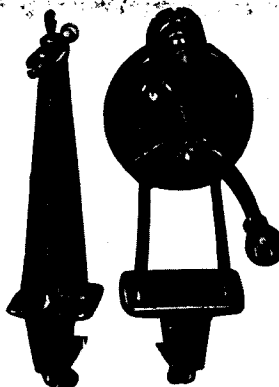

ALL PRICES F. O. B. CHICAGO, ILLINOIS

**HOLMES PROJECTOR CO., 1815 Orchard Street, Chicago 14, Ill.**