

FILM-TECH

THE INFORMATION CONTAINED IN THIS ADOBE ACROBAT PDF FILE IS PROVIDED AT YOUR OWN RISK AND GOOD JUDGMENT.

THESE MANUALS ARE DESIGNED TO FACILITATE THE EXCHANGE OF INFORMATION RELATED TO CINEMA PROJECTION AND FILM HANDLING, WITH NO WARRANTIES NOR OBLIGATIONS FROM THE AUTHORS, FOR QUALIFIED FIELD SERVICE ENGINEERS.

IF YOU ARE NOT A QUALIFIED TECHNICIAN, PLEASE MAKE NO ADJUSTMENTS TO ANYTHING YOU MAY READ ABOUT IN THESE ADOBE MANUAL DOWNLOADS.

WWW.FILM-TECH.COM

001-00-001

englisch

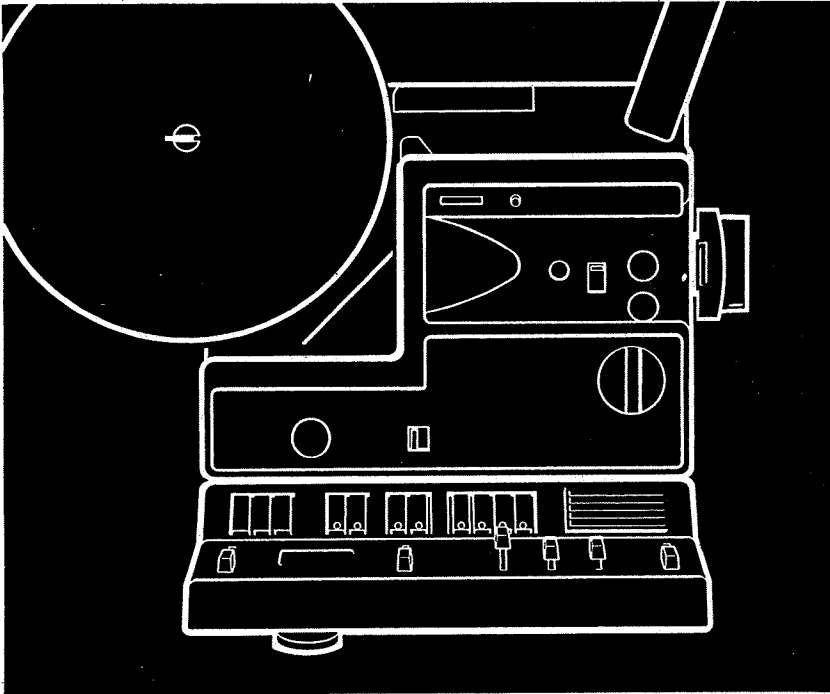

eumig®

S 938

stereo sound

Instructions for use

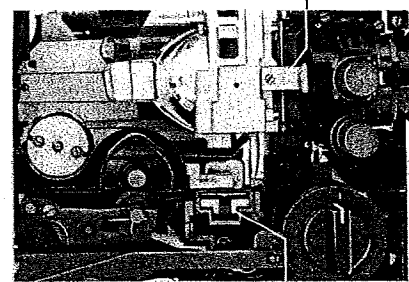
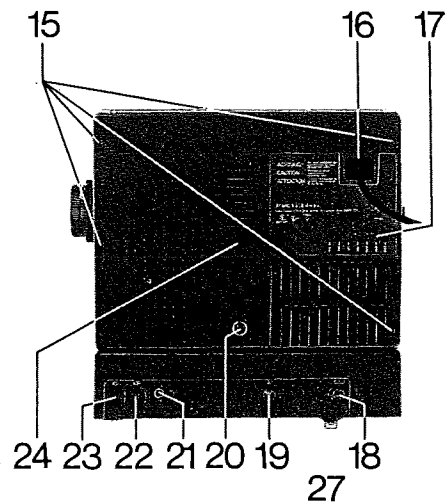
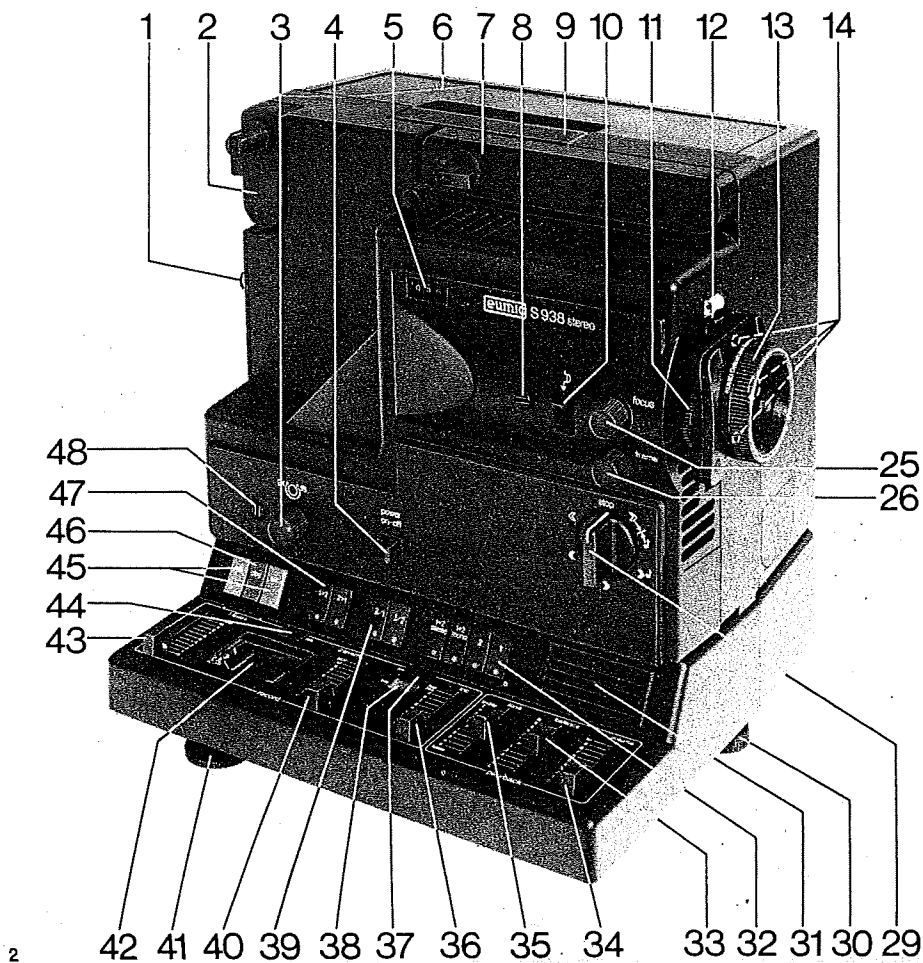

Description of the projector

- | | | | |
|----|---|----|---|
| 1 | Inching knob | 26 | Frame line correction |
| 2 | Rear reel arm | 27 | Film pressure pad lock |
| 3 | Running speed adjustment | 28 | Sound head pressure pad |
| 4 | Mains switch | 29 | Rotary selector switch |
| 5 | Running counter with zero resetting key | 30 | Front levelling adjustment |
| 6 | Swing-open lid of compartment for mains lead etc. | 31 | Pilot light |
| 7 | Front reel arm | 32 | Sound track selector keys |
| 8 | Front cover fixing screw | 33 | Balance control |
| 9 | Extending carrying handle | 34 | Volume control |
| 10 | Film loop restoring key | 35 | Tone control |
| 11 | Zooming mount on lens | 36 | Mixing control |
| 12 | Film threading slot | 37 | Green-power signal lamp |
| 13 | Optical levelling adjustment on lens | 38 | Yellow-mixing signal lamp |
| 14 | Mounting holes for daylight viewer (optional extra) | 39 | Duoplay automation keys |
| 15 | Back cover fixing screws | 40 | Right-hand recording level control (balancing stripe No. 2) |
| 16 | Mains lead | 41 | Lateral levelling adjustment |
| 17 | Voltage selector window | 42 | Recording level indicator |
| 18 | Phono/tape/microphone input socket | 43 | Left-hand recording level control (main stripe No. 1) |
| 19 | Line output socket | 44 | Red-recording signal lamp |
| 20 | Auto-start socket | 45 | Recording keys |
| 21 | Earphone socket | 46 | Replay key |
| 22 | Right-hand external speaker socket | 47 | Multiplay keys |
| 23 | Left-hand external speaker socket | 48 | Front cover fixing screw |
| 24 | Compartment for reel holder | | |
| 25 | Focusing knob | | |

Before switching on

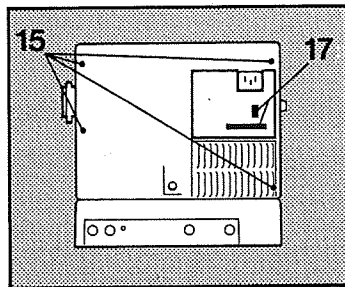

Checking the voltage

Check that your projector's mains voltage and frequency specifications match the values on your mains supply meter. The voltage setting of the projector is indicated on the data panel or visible in the window (17). If the voltage setting does not match your mains supply, ask your movie dealer or an authorised servicing centre to adjust it.

For the servicing engineer:

Unscrew the fixing screws (15) and remove the back. **Take care not to damage the loudspeaker lead between the back and the projector.**

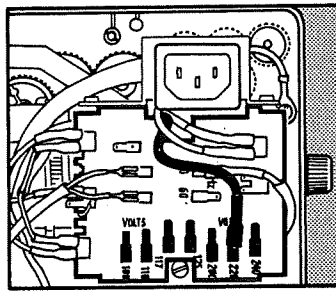

Changing the voltage

Only for the specialist

Pull off the red plug from above and attach it to the appropriate terminal.

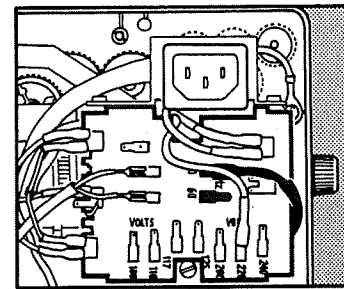

Changing the supply frequency

Only for the specialist

Seek the advice of an expert if required.

A version of this projector is available with a frequency adjustment for countries with different supply frequencies. Changing the frequency involves refitting the drive belt and switching the transformer plug to the appropriate terminal for 50 or 60 Hz. Get one of our servicing centres to do this for you.

If local mains voltage fluctuations cause premature projection lamp failure, we recommend that you switch to the next higher voltage setting where feasible (for instance 230 instead of 220 volts). This extends the burning life of the lamp with a slight reduction in light output.

4

Putting on the show

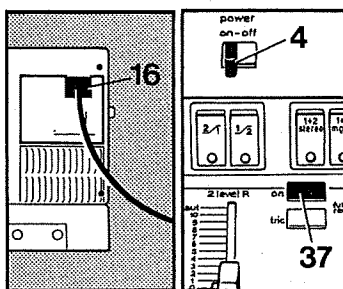

Connecting to the mains supply

Plug the mains lead (16) of the projector into a mains supply socket. Push the mains switch (4) to the left to "On".

This switches on the projector: The green signal lamp (37) and the pilot light (31) light up, the motor starts and the projection lamp is pre-heated.

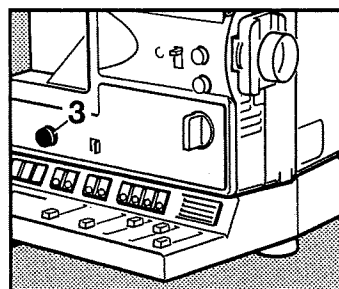

Setting the running speed

To set the running speed — 18 or 24 frames/second or any intermediate position — turn the knob (3) to the appropriate position.

The running speed may be changed even during projection.

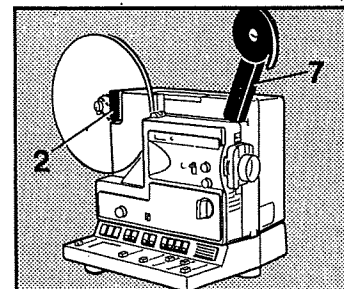

Fitting the reels

Swing up the front reel arm (7) and place the full reel on its shaft so that the film runs off the reel clockwise towards the front. Turn over the reel lock. Place the empty reel supplied on the shaft of the rear reel arm (2). This holds up to 180 m (600 feet) film. If you are using a 240 m (800 feet) reel, swing out the rear reel arm before fitting the reel. Turn over the rear reel lock.

Note: When you are looking from the rear of the projector towards the screen, the perforations must be at the right.

*) The mains switch and rotary selector switch (29) are interlocked: you can only turn the selector switch when the mains switch is on and you can only switch off the mains switch when the rotary selector switch is at "Stop".

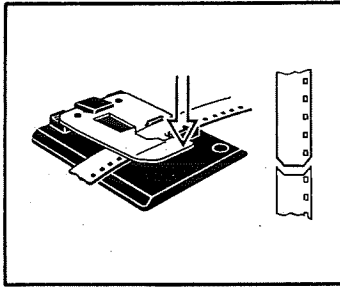

Trimming the film leader

Check the state of the film leader. It must be free from kinks and creases, curled clockwise and have a cleanly trimmed end. Use the film trimmer supplied to trim the film end as follows: Push the film end into the trimmer so as to engage a perforation hole in the tooth of the film guide then push down the trimming lever (see arrow).

If you peel off the protective film from the self-adhesive base you can stick the film trimmer to any convenient spot on the projector.

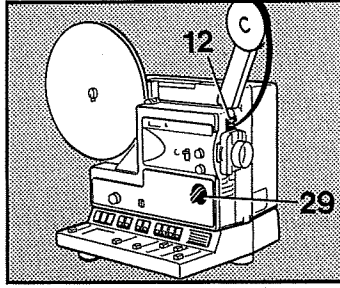

Threading

Turn the rotary selector switch (29) from the "Stop" position to the threading position \gg . (You cannot thread the film if you have not turned the selector via "Stop".) Push the film leader into the threading slot (12) until the mechanism seizes the film. Threading then proceeds automatically through to the take up reel.

Note: Thin-base films may not always attach themselves automatically to the take-up reel. In that case guide the beginning of the film into the reel core by hand.

If the film is not correctly advanced during threading (for instance due to a badly trimmed film end) the film emerges from an opening below the lens to avoid damage. In that case turn the rotary selector switch (29) to reverse \ll , retrim the film and repeat the threading procedure.

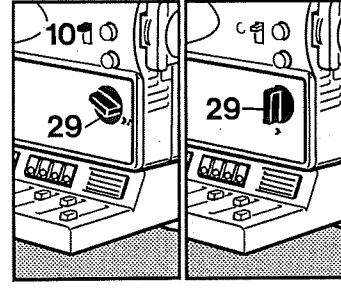

Projection

As soon as the film runs on to the take-up reel, turn the rotary selector switch (29) further:

- to \gg for sound projection of sound film;
- to \gg for silent projection of silent film (to protect the sound heads).

Note: If the image jitters or the film rattles (or both) during projection, briefly press the loop restoring key (10).

The likely cause might be a faulty splice or damaged perforation holes.

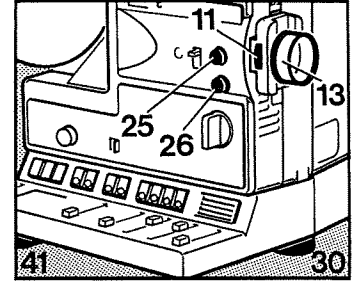

Adjust the projected image size with the zooming mount (11) on the lens and focus the image with the focusing knob (25). If the frame line between frames appears on the screen, adjust the frame line control (26) accordingly. Level the projector with the milled screws (30,41). Raise or lower the projected image on the screen with the optical levelling adjustment (13).

Switching on the projection lamp also starts the fan running which cools the 150 volt lamp. Check fan operation by seeing whether air blows out of the upper ventilation slots. If the fan fails to run - see page 23 - change the fuse for the fan.

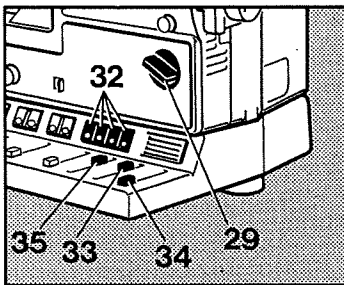

Sound projection

Turn the rotary selector switch (29) to sound projection \gg . Press the appropriate sound track selector key (32):

Key "1": Playback of main stripe (normal sound films, library films etc.).

Key "2": Playback of balancing stripe.

Key "1+2 mono": Combined playback of main and balancing stripe through both channels.

Key "1+2 stereo": Playback of main stripe through the left-hand channel and balancing stripe through the right-hand channel.

Adjust the volume with the sliding volume control (34), the tone reproduction with the tone control (35).

Use the balance control (33) to balance the volume of the two tracks.

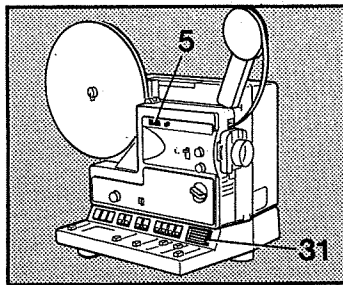

In every one of these operating modes the pilot light (31) illuminates the area of the sliding playback controls to permit easy adjustment during sound projection. The running counter (5) helps you to find the first frames of a shot. At 18 fps. each counter unit is equivalent to 1 second: you can thus directly read the duration of a shot when running at 18 fps. Press the button to the right of the counter to reset it to 0.

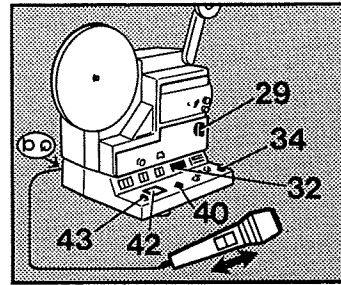

Public address

You can make direct announcements through the microphone in all playback settings as well as with silent film and even without projection. Plug the microphone into the DQ socket (18), switch on the projector and press one of the four track selector keys (32).

- While speaking into the microphone, push the recording level controls (40,43) up from "0" until the level indicator needle (42) swings out towards the 0 dB mark.
- Set the rotary selector switch (29) to "Stop" or to silent or sound projection \gg .
- Adjust the volume with the volume control (34).

During sound projection the playback volume of the two tracks is attenuated as long as the microphone switch is switched on and so provides a correct relative level to your spoken commentary. During speech intervals move the microphone switch to "off".

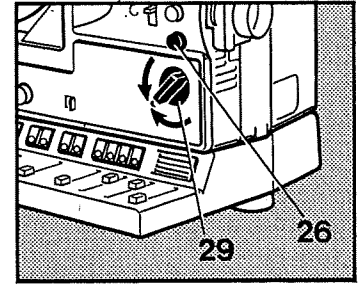

Reverse projection

Turn the selector switch (29) - in either direction - to reverse projection \ll ; the film now runs backwards and the movement on the screen appears reversed. When changing the running direction you will usually have to correct the frame line setting (26).

You cannot play back sound during reverse projection.

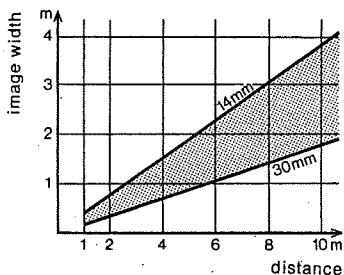

Screen image sizes

This graph shows the relationship between image width, focal length and projection distance. It applies to the built-in multicoated 14-30 mm Eumig Optical Level System $f/1.3$ lens. For instance with a projection distance of 4 m the image on the screen is adjustable between 0.75 and 1.4 m.

Concluding the show

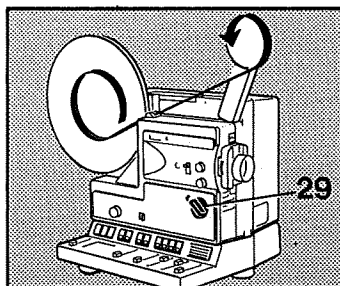

Rapid rewinding

Once the film has run through, take its end directly to the front reel and attach it to the core. Turn the rotary selector switch (29) to reverse \leftarrow . This now rewinds the film onto the front reel.

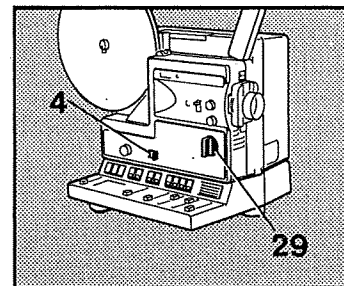

Switching off

At the end of every show turn the rotary selector (29) to "stop". Push the mains switch (4) to the right to "off". This switches off the projector.

Sound recording

The Eumig S 938 Stereo Sound projector offers a wide range of sound recording methods for almost unlimited scope of individual control. The procedures are largely automated: you can devote your attention to recording without having to worry over technicalities. With the Eumig S 938 Stereo Sound even straightforward sound recordings sound most impressive.

First however the fully edited film must be striped. If you want to record sound with a usual single-track system, a single main stripe on the film is sufficient:

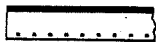

If you want to record in twin track mode or stereo, have the film striped with a main and a balancing stripe:



With this method of striping you can utilise all sound recording modes of the projector. Live sound films are already provided with both stripes.

The following pages introduce the operating controls of the sound section and their function, and then list the various sound recording methods followed by more detailed explanations.

First the special features of the projector in brief:

Automatic level control provides all-over optimum quality of the sound recording without volume fluctuations from the start. The recording level indicator shows correct operation of the automatic system. Choose **manual level control** for extra high quality in music reproduction. Set the correct level in this case with the two sliding controls while observing the recording level indicator.

By **mixing** it is possible to superimpose a new recording over an existing recording on the same track, controlling the relative modulation levels of the two recordings with the mixing control. You can fade this superimposed recording in or out either manually with the mixing control or automatically via the microphone switch.

An important advantage of this projector is **twin track recording**. Each of the two stripes (the main and balancing stripe) may be recorded in the modes just described. You can do this separately for each track, for instance to produce a film in two independent sound versions. Or you can record additional matter on the balancing stripe to supplement a live sound recording (made in the sound camera) and play back both together. Or again, you can record commentary and background music separately on each track and play back both tracks together. That way fluffed lines are no problem, as the background music is on the other

stripes this projector offers a further interesting automatic feature: **Duo-play automation**, where either track controls the playback level of the other. You record a commentary on one stripe and the music on the other in the normal way; on playback the commentary passages then automatically attenuate the music.

During recording the same switching position also allows you to monitor not only the track being recorded but also the already recorded sound on the parallel track. That way you can easily match both recordings to each other.

By the **multiplay procedure** you can transfer sound from one track to the other. There you can manipulate and mix at will without affecting the original recording. During such a track transfer you can of course also mix in a new recording, for instance a commentary.

Stereo recordings are very easy with this projector because automatic recording level control and mixing are equally effective in stereo.

(The sound recording methods listed for twin track procedures are however not usable in stereo as dual channel recording of stereo requires both stripes at the same time.)

The projector has an **Auto-start control** to permit precise starting up of the sound recording. This starts the tape recorder during projection at the exact point that you have preprogrammed and at the same time starts the sound recording.

A very useful aid to sound recording is the accessory Eumig daylight viewer. We would also recommend the Eumig universal stereo re-recording lead

The sound section controls

Recording and erasing keys

When you depress the two red keys together the red recording signal lamp (44) lights up to show that the unit is ready for recording. At this point you can already monitor the recording level with the recording level indicator (42). To start recording, turn the rotary selector switch (29) to sound projection \rightarrow ; turning it back to "Stop" automatically switches over to playback. A new recording erases any previous recording (except during mixing). If you just want to erase without recording anything fresh, first move the two recording level controls (40, 43) to "0".

The playback key

Pressing the green playback key instantly switches the projector from recording to playback. During normal sound projection there is no need to press the playback key separately.

Recording level control

Automatic recording level control

Pushing the sliding controls to "aut" cuts in automatic recording level control separately for each channel; the left-hand sliding control for the left-hand channel (main stripe) and the right-hand control for the right-hand channel (balancing stripe).

Manual level control

The manual level control range runs between settings 0 and 10 on the scale of the two sliding controls. Again the left-hand adjustment controls the left-hand channel (main stripe), the right-hand adjustment the right-hand channel (balancing stripe).

The programming keys

The programming keys carry built-in yellow LEDs. When a key is switched on, its LED lights up. Any depressed key springs out on pressing another key.

The **multiplay keys** permit re-recording of the sound from one track to the other:

"1 > 2": Re-record from track 1 (main stripe) to track 2 (balancing stripe).

"2 > 1": Re-record from track 2 (balancing stripe) to track 1 (main stripe).

For this, set the projector to recording. (In the playback mode the multiplay keys switch off the amplifier — you hear nothing.)

The **Duoplay automation keys** play back both tracks together, but the sound of one track controls the playback volume of the other.

"2 / 1": The signal of track 2 (balancing stripe) controls the volume of track 1 (main stripe).

"1 / 2": The signal of track 1 (main stripe) controls the volume of track 2 (balancing stripe).

Select the basic setting of the relative volumes of the two tracks with the balance control.

During recording on one track you can with these keys not only monitor that recording but at the same time also the parallel recording on the other track.

"2 / 1": Record and monitor track 2, Monitor track 1.

"1 / 2": Record and monitor track 1, Monitor track 2.

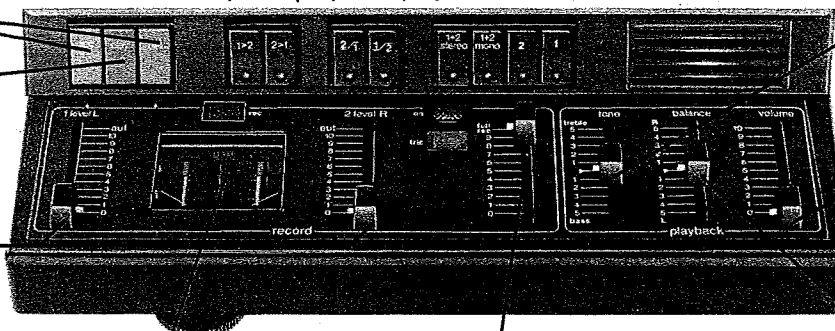

Recording level indicator

The indicator shows the recording level for the channel in use (i.e. left-hand needle for track 1 or main stripe, right-hand needle for track 2 or balancing stripe). At a correct recording level setting the needle swings out up to "0 dB" (occasional swings into the red area are permissible). The recording level indicator scale is lit during recording.

Mixing control ("tric")

With the mixing control you can mix commentary or special effects on to the same track during a second recording run and at the same time attenuate the first recording. The mixing control is also used for soft music transitions.

As you switch on the control, the yellow mixing indicator (38) lights up.

With the control set to "0", the first recording is not affected. The further you push the control towards "full rec" the more the first recording is attenuated and the new recording accentuated. In the "full rec" position the first recording is completely erased; the yellow mixing signal (38) goes out.

The mixing control can be used in all recording modes. When not required, always move it to "full rec".

10

The **track selector keys** select the required operating mode for recording and playback:

"1": Main stripe or left-hand channel.

"2": Balancing stripe or right-hand channel.

"1 + 2 Mono": Main and balancing stripe together through both channels, mono mode.

"1 + 2 Stereo": Main and balancing stripe together through separate channels (stereo mode).

Tone control

In its mid position the tone control yields level playback quality. When set to "bass" it boosts the low frequencies, in the "treble" position the high frequencies.

The tone control does not affect the recording.

Volume control

Use the volume control to set the playback volume during sound projection and the monitoring volume level during recording when checking the recording signal level. The position of the control does not affect the recording except with microphone recordings where you may get acoustic feedback (whistling); so preferably monitor with earphones.

Balance control

The balance control adjusts the relative volumes of the two channels during stereo playback. During mono or twin track playback the balance control also adjusts the share of the two tracks in the combined effect (key positions "1 + 2 Mono", "2 / 1", "1 / 2").

The control is also in operation during recording (for monitoring)

Input and output sockets

Earphone socket

The earphone socket takes all stereo headphones with 6.3 mm (1/4 inch) diameter jack plug. This switches off all speakers. Adjust the volume with the volume control (34).

Line output

The line output can feed into an amplifier or a stereo hi-fi unit. The connecting lead must however be correctly wired.

In view of the range of different plugs and connecting modes of external playback units we recommend the use of the Eumig universal stereo re-recording lead.

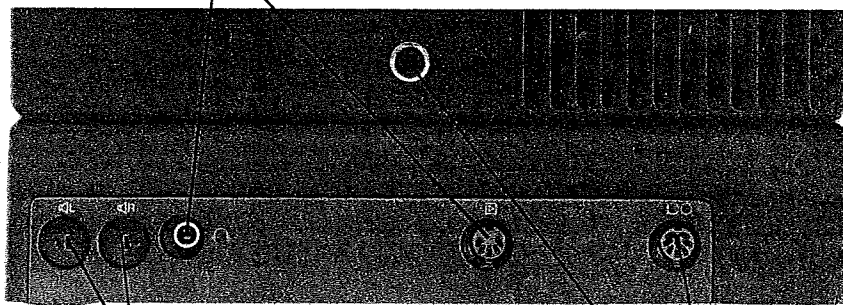

Loudspeaker outputs

Use the loudspeaker output sockets to connect external speakers, for instance to set them up near the screen so that the sound comes from the front as in a cinema.

Connecting modes:

- One speaker plugged into the left-hand socket: you hear both tracks through the external speaker, the built-in speaker is switched off.
- One speaker plugged into the right-hand socket: you hear the main stripe (left-hand channel) through the built-in speaker and the balancing stripe (right-hand channel) through the external speaker.
- One speaker plugged into the left-hand socket, one into the right-hand socket: you hear the main stripe recording (left-hand channel) through the left speaker and the balancing stripe recording (right-hand channel) through the right speaker. The built-in speaker is switched off.

With stereo operation each signal is played back through its appropriate channel; in all other cases the same signal comes through both speakers.

Input

Plug the sound playback unit (record player, tape recorder etc.) or microphone into the input socket.

A stereo microphone can be connected directly to this socket; when using two mono microphones for stereo recording, you need a stereo microphone adapter (special accessory).

Auto-start socket

Plugging an Auto-start lead into this socket activates the Auto-start control: during projection it starts

Sound recording methods

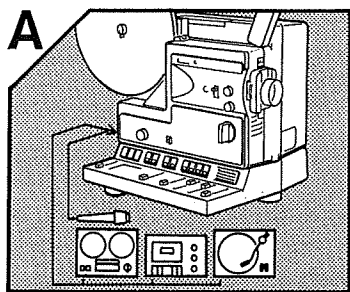

Speech and music

Microphone recording

Microphone recording is the simplest and most straightforward way of recording sound. Use this when you merely want to add a commentary to the film.

See page 13

Music recording

Re-record music directly via a lead from the cassette recorder, record player, tape recorder etc. Music transitions can be soft or abrupt.

See pages 14 and 15

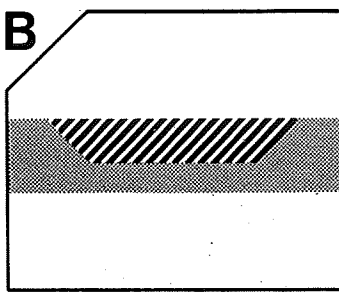

Mixing techniques

You can mix a commentary into an existing sound recording on the same track during a second run through of the film. Depending on the mixing control setting, the first recording is then attenuated to a greater or lesser degree. You can also mix in other sound effects during the second run. You can fade the commentary in and out automatically with the microphone switch, or manually with the mixing control itself.

See pages 16 and 17

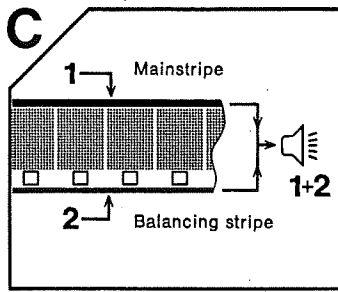

Twin track recording

Twin track recording offers a number of interesting sound recording possibilities:

- Two completely different sound versions of the same film (for instance in two different languages).
- Separate recordings of commentary and music on separate tracks followed by combined playback - with Duoplay automation if required.
- Easy correction of slips of the tongue, fluffed lines etc. with separate recording of speech and music.
- Adding to live sound recordings without risk of spoiling the original recording.

The film must of course carry a main and a balancing stripe.

See pages 18 and 19

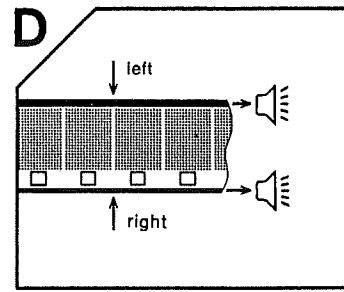

Stereo

Stereo implies hearing with spatial orientation - you distinguish between left and right and hear the instruments of an orchestra from the direction where they were during the recording (even from the centre between the speakers). For this the film must have a main and a balancing stripe. The sound source (disc, tape recording or cassette) and the playback units must of course be stereophonic. All recording methods listed under "A" and "B" can be used in stereo, but not the twin track recording methods in section "C" as stereo records both sound tracks at the same time.

See page 20

A Speech and music

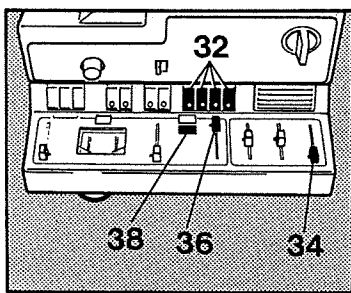

Microphone recording

- Plug the microphone into the DQ input socket (18). Move the microphone switch to "Off". (For stereo recording with the microphone see section "D" - stereo on page 20).
 - Select the track on which you want to record by pressing the appropriate track selector key (32):
Mono: key "1", "2" or "1+2 Mono";
Stereo: key "1+2 Stereo".
 - To avoid acoustic feedback (whistling) set the volume control (34) to "0". (If you monitor through earphones, use the volume control to adjust the monitoring volume.)
 - Set the mixing control (36) to "full rec"; the yellow signal lamp (38) must be out.
- Now select automatic or manual recording level control.

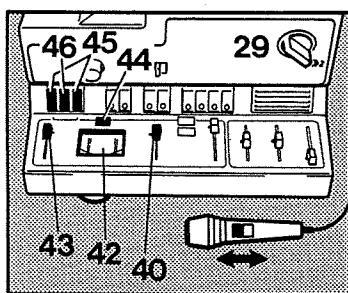

Automatic level control

- Push the sliding controls (40, 43) to "aut".
 - Press the red recording keys (45); the red signal (44) lights up.
 - Turn the rotary selector switch (29) fully to forward projection.
 - Push the microphone switch to "on". The scale of the recording level indicator (42) lights up.
 - Speak into the microphone.
 - During breaks in the commentary push the microphone switch to "off" to avoid recording extraneous noise.
- The microphone switch fades the recording softly in and out. The special automatic gain and frequency control system (AGFC) ensures a correct audio effect even at different distances between the microphone and the sound source. To conclude the recording turn the selector switch (29) to "stop" or press the green playback key (46).

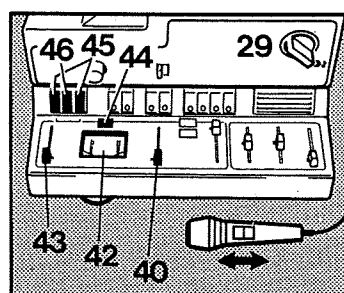

Manual level control

- Push the sliding controls (40, 43) to "0".
- Press the red recording keys (45); the red signal (44) lights up.
- Make a trial recording run: move the microphone switch to "on", speak into the microphone and adjust the appropriate control (40, 43) - left-hand control for track 1, right-hand control for track 2, both controls for tracks 1+2 - until the appropriate recording level indicator (42) needle swings out to the 0 dB mark. Occasional swings into the red range are permissible. Leave the control in this position.
- Push the microphone switch to "off".
- Turn the rotary selector switch (29) fully to forward projection.
- Push the microphone switch to "on". The recording level control (42) scale lights up - you are recording.
- Speak your text into the micro-

The microphone switch ensures soft fading in and out of the recording.

- To conclude the recording turn the selector switch (29) to "stop" or press the green playback key (46).

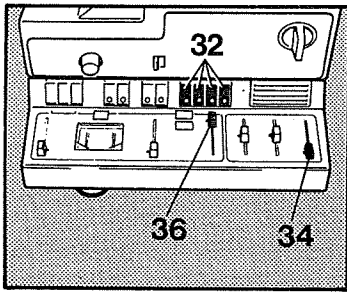

Music recording

- Plug the music playback unit (tape recorder, record player etc.) into the DQ input socket (18).
- Select the track to be recorded by pressing the appropriate track selector key (32): Mono: key "1", "2" or "1+2 Mono"; Stereo: key "1+2 Stereo".
- Set the mixing control (36) to "full rec"; the yellow signal lamp must be out.
- You can control the monitoring volume (via the loudspeaker or a plugged-in earphone) with the volume control (34).

Now select automatic or manual recording level control.

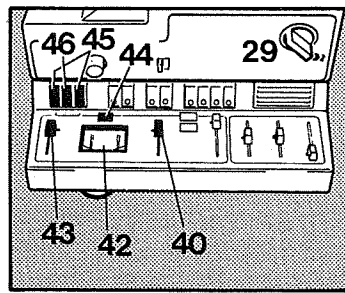

Automatic level control

- Push the sliding controls (40, 43) to engage at "aut".
- Press the red recording keys (45); the red signal lamp (44) lights up.
- Start the sound playback unit.
- Turn the rotary selector switch (29) fully to forward projection (▶). The recording level indicator scale (42) lights up; you are now recording.*
- To conclude the recording turn the selector switch (29) to "stop" or press the green playback key (46).

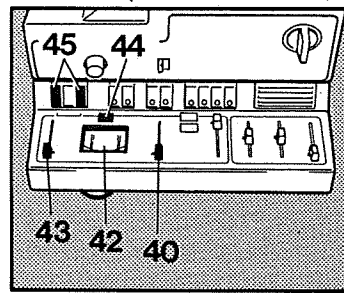

Manual level control

- Push the sliding controls (40, 43) to "0".
- Press the red recording keys (45); the red signal lamp (44) lights up.
- Make a trial recording run: start the playback unit and adjust the appropriate control (40, 43 - left-hand control for track 1, right-hand control for track 2, both controls for tracks 1 and 2) until the appropriate level indicator (42) needle swings out to the 0 dB mark during the loudest passages. Occasional swings into the red range are permissible.

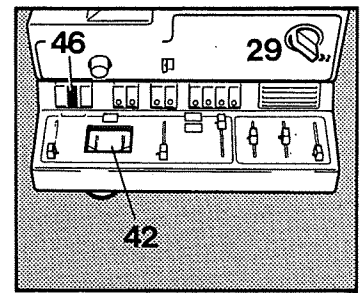

- Turn the rotary selector switch (29) fully to forward projection (▶). The scale of the level indicator (42) lights up.*
- Keep an eye on the recording level indicator (42) so that you can correct the level as necessary.
- To conclude the recording turn the selector switch (29) to "stop" or press the green playback key (46).

If the recording level indicator needle never rises beyond -10 dB, the output of the playback unit is insufficient or the plug polarity needs reversing. If the needle remains all the time between 0 and +3 dB, the playback unit output voltage is too high or the plug again needs reversal in polarity.

*) For sound recordings where you need no projection light, turn the rotary selector switch from ▶ back to ◀. This maintains all running and sound recording functions but switches off the projection lamp to prolong its life. However be sure **not** to thread a film after this switching back. (see page 6).

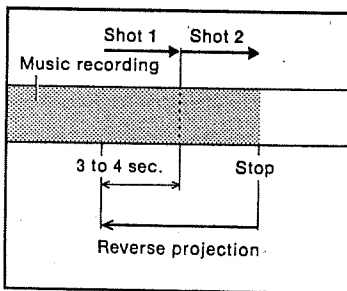

Soft music transitions

- If you want to switch the music with a change of scene, a soft music transition or dissolve is recommended for shots of similar nature.
- First record the music for shot No. 1.
 - A few seconds after the picture cut, stop the projector and let it run back about 3-4 seconds past the cut.

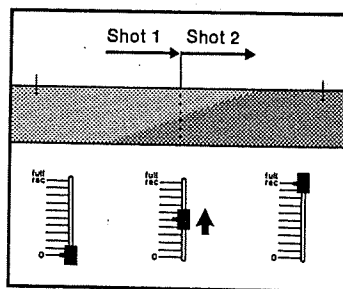

- Push the mixing control (36) to "0". The yellow mixing signal lamp (38) lights up.
 - Start the music for the second shot.
 - Press the red recording keys (45) and switch fully to forward projection (▶).
 - Slowly push the mixing control to "full rec".
- This concludes the dissolve procedure; music No. 2 is now being recorded.

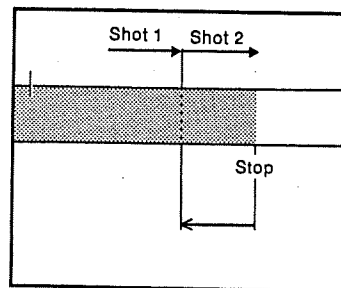

Abrupt music cuts

- For cuts between radically different shots an abrupt music cut is recommended. In this case the mixing control (36) remains in the "full rec" position all the time.
- Stop the music recording No. 1 after the cut between the shots.
 - Bring the point of the cut exactly into the film gate with the inching knob (1) - push it in and turn. With the preheated lamp a faint projected image remains visible.

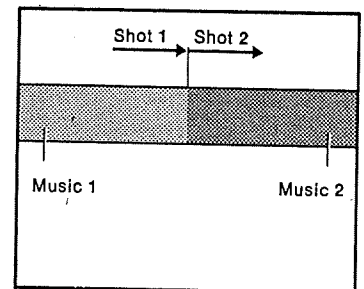

- Press the red recording keys (45).
- Start the external sound playback unit, and
- switch the projector to forward projection (▶).

Note: You can also make abrupt music cuts with the aid of the Auto-start control. The procedure is described on page 21.

B

Mixing techniques

Superimposing a new recording on an existing recording on the same track.

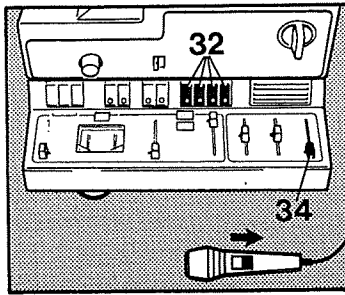

Mixing in speech via the microphone

(with automatic mixing control)

For sound recordings with music and commentary on the same track first record the music (see page 14). Then record the commentary with the aid of the mixing system during a second run through.

After the music recording:

- Rewind the film and rethread it.
- Keep the same track selector setting (keys 32).
- Plug the microphone into the input socket (18) and move the microphone switch to "off".
- Push the volume control (34) to "0" to eliminate any risk of acoustic feedback.

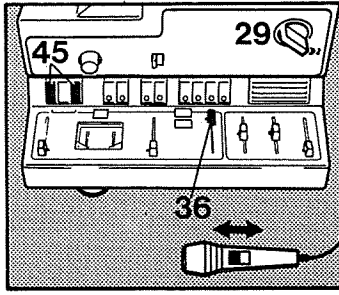

- Adjust the mixing control (36) to preset the degree of attenuation of the music and the recording volume of the commentary. The further you move the control towards "9" on the scale, the more the music is attenuated and the commentary enhanced. (The best way is to establish the setting by trial — usually just below "8" is suitable.)
- Press the red recording keys (45) and turn the rotary selector switch (29) to forward projection

- As soon as a shot appears to which you propose to add a commentary, push the microphone switch to "on". This attenuates the first recording.
- Now speak the commentary into the microphone.
- Slowly switch off the microphone: this slowly fades in the music to full volume again. Repeat this fading in and out procedure for every speech passage.

Speak only when the recording level indicator is fully lit up (this takes about 1 1/2 seconds).

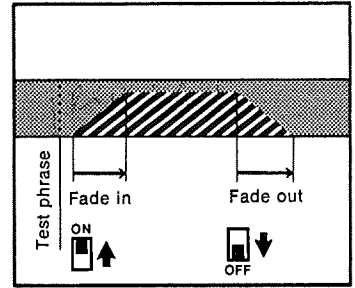

Here the sequence is shown diagrammatically. As long as the microphone switch is at "off" the first recording remains unaffected. The music/commentary level ratio is preset with the mixing control. On moving the microphone switch to "on" the fade-in sequence starts. On moving the microphone switch to "off", fading out begins. To cancel the recording standby condition, turn the rotary selector switch (29) back to "stop" or press the green playback key (46).

To avoid recording extraneous sounds at the beginning of the commentary, speak a triggering word — for instance "Now!" — into the microphone immediately before switching on.

You can also mix in the speech manually: keep the microphone switch at "on" and control the fade in and out with the mixing control (36) as described in the next section.

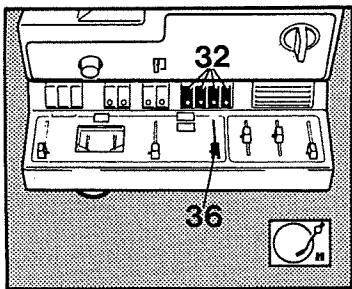

Mixing in music and special effects

After completing the first recording:

- Rewind the film and rethread it.
- Keep the same track selector setting (keys 32).
- Plug the playback unit (record player, tape recorder etc.) into the DQ input socket (18).
- Push the mixing control (36) to "0".

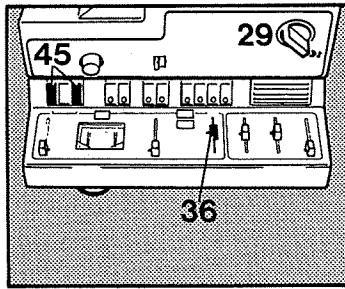

- Press the red recording keys (45), and
- turn the rotary selector switch (29) to forward projection
- Start the playback unit either now or as soon as the required scene appears on the screen.
- As soon as you see the appropriate scene, push the mixing control (36) towards "9". The position of the mixing control determines the degree to which the first recording is attenuated and the new recording boosted.
- After the recording push the mixing control (36) back to "0". This brings the first recording back to its original level.

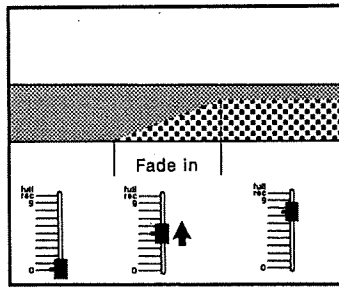

Here is the procedure shown diagrammatically: As long as the mixing control is at "0", the first recording (for instance music) is unaffected.

The further you move the mixing control towards "9", the more the volume of the first recording is attenuated and that of the second recording (for instance special effects) boosted.

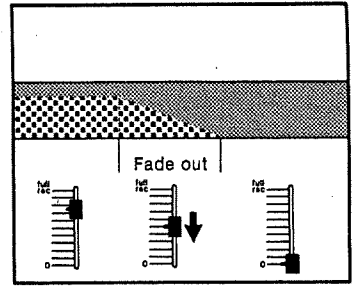

The sequence is similar during a fade out which is concluded as soon as the mixing control is back at "0".

To cancel the recording standby condition turn the rotary selector switch (29) back to "Stop" or press the green playback key (46).

C Twin track recording

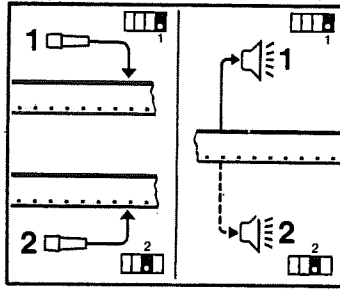

Two sound versions

If you need two sound versions for a film (for instance two separate commentaries or two different languages), first prepare a complete sound recording for the first version on the main stripe (track selector key "1"). Then wind the film back, press the track selector key "2" (32) for the balancing stripe and record version No. 2. You can use any of the recording methods for each track as listed in sections A and B. On playback you then have a choice of two different sound programs.

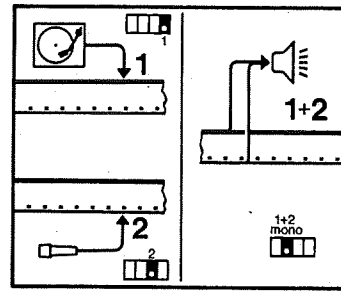

Splitting the sound between two tracks

It may be useful to plan the recording from the outset for two tracks, for instance the commentary on track 2 and music on track 1. To play back both together, then press the "1+2 Mono" track selector key (32). The advantage is that you can correct either track separately without affecting the other. Thus you can replace a faulty commentary in part or in whole without interfering with the music on the other track. If you want to enhance the music for dramatic effect in selected sequences or attenuate it in others, adjust it with manual recording level control (page 13 and 14).

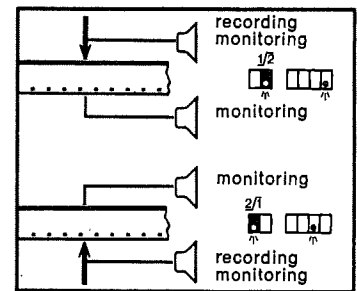

Monitoring twin track recordings

If you want to match the recording of one track precisely to an existing recording of the other track:

- Press the "2 / 1" or "1 / 2" key to monitor the parallel track while recording the new one.
- With the key "2 / 1" you monitor the recording on track 2 while also listening to the playback of track 1.
- With key "1 / 2" you monitor the recording on track 1 and listen also to the playback on track 2.

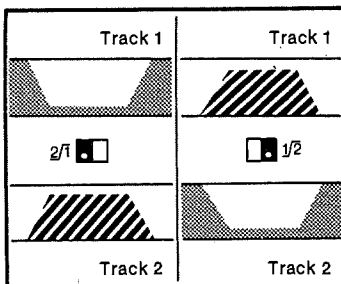

Duoplay automation

A very simple way of controlling the interaction of two tracks is to record — for instance music — on track 1 and speech on track 2 in the normal way and then to press one of the two keys (39) (in this case key "2 / 1") to switch to Duoplay automation for playback. The automatic system then attenuates the music during speech passages and restores it to full volume during speech intervals. Hence the speech controls the level of the music. Key "2 / 1": track 2 controls track 1. Key "1 / 2": track 1 controls track 2.

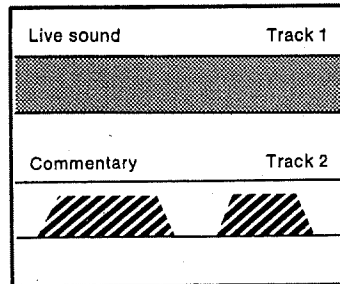

Adding to live sound recordings

Sometimes you may want to add commentary to a shot with live sound. With twin track recording you can record the commentary on the balancing stripe — press the track selector key "2" (32). This preserves the live sound recording unchanged and plays it back together with the commentary on pressing the track selector key "1+2 Mono" or the Duoplay key "2 / 1" (see column at left).

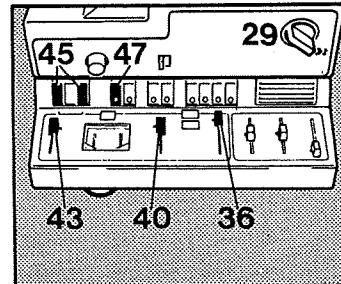

Multiplay technique

With Multiplay you can directly record one track on the parallel track. That way you can add special effects or commentary to the re-recorded track, using the mixing techniques already described (page 16–17). This recording method preserves the original sound unchanged. For example you may want to add further sound to a live sound film. So re-record track 1 on to track 2.

- Thread the film.
- Set the recording level controls (40, 43) to "aut" and the mixing control (36) to "full rec".
- Press the red recording keys (45).
- Press the multiplay key (47), in this case "1>2".
- Turn the selector switch (29) to forward projection >>.

This starts the re-recording.

Important: Do not connect any playback unit or microphone to the DQ input socket (18).

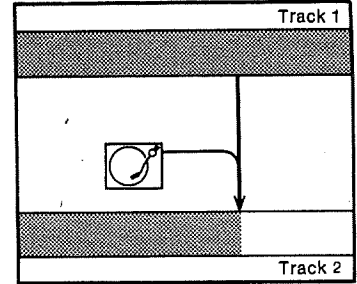

Mixing of music/sound effects

In addition you can — still using the same example — add special sound effects or music to the live sound even during re-recording. This again preserves unchanged the original live sound recording.

- Thread the film.
- Connect the playback unit etc.
- Turn the recording level controls (40, 43) to "aut".
- Press the "1>2" Multiplay key (47).
- Turn the selector switch (29) to >>.

The mixing level ratio between the re-recorded and the new signal is fixed automatically.

D Stereo

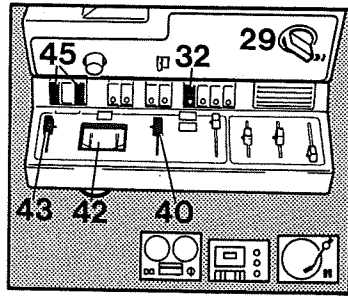

Recording music in stereo

- A stereo music recording is as easy as a mono recording, as described on pages 14 and 15. The difference is that you record on both tracks at the same time from the outset: the left-hand channel on track 1 and the right-hand channel on track 2. The film must thus carry both a main and a balancing stripe.
- Plug the sound source output into the DQ input socket (18).*
 - Press the "1+2 Stereo" track selector key (32).
 - Select automatic or manual recording level control (40,43).
 - Press the red recording keys (45).
 - Start the sound playback unit.
 - With manual recording level control adjust the controls (40, 43) to the required needle position on the level indicator (42).
 - Turn the rotary selector switch (29) to \blacktriangleright .

*) To avoid connection or patching problems, use the Universal stereo re-recording lead.

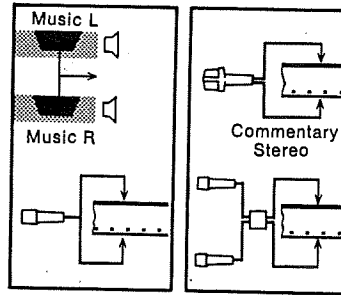

Commentaries

As stereo microphone recordings need some practical experience, we suggest that for recording commentaries you use the mono microphone supplied with the projector (see page 13 or, if you want to mix the commentary into a music recording, page 16). On stereo playback the speech appears to come from the centre which is usually ideal, anyway. For microphone recordings in stereo you need either a stereo microphone or – as separate accessories – a second mono microphone and the stereo microphone adapter.

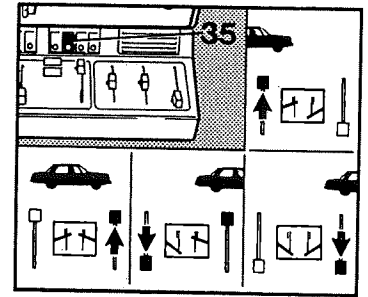

Directional stereo recording with mono sound sources

You may want to carry out such recordings to move the apparent origin of a sound from left to right (or right to left) – for instance a passing car.

- Plug the playback unit into the DQ input socket (18).
- Press the "1+2 Mono" track selector key (32).
- Push the recording level controls (40,43) to "0".

During the recording you can then control the sound according to its direction of movement. For example for a left-to-right movement, first advance the left-hand control (43) slowly up to the full 0 dB level (the sound approaches from the left), then push the right-hand control (40) to the same level and immediately after that pull back the left-hand control (the sound moves from left to right); finally pull the right hand control slowly back to "0" (the sound disappears at the right).

Use the stereo earphones or two speakers to monitor the recording.

The Auto-start control

The Auto-start control ensures precise starting of the sound playback unit at the beginning of the shot to which you want to add sound and also starts the recording itself. This automatic device is operative as soon as the jack plug is plugged into the Auto-start socket (20).

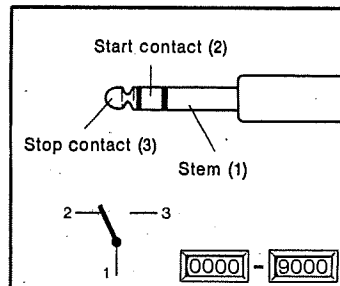

To provide the sound from a suitable recording use a tape recorder or cassette recorder with remote control. Connect the remote control socket of this recorder (usually marked "remote") to the Auto-start socket (20) via a suitable Auto-start lead. The exact lead required depends on the tape or cassette recorder used. The starting lead is available as an accessory from your movie dealer (Order No. 790.0304/7). One end carries a jack plug to fit the projector, the other end has three wires to which you can solder a suitable plug or jack to fit your recorder. The diagram above shows the wiring of the socket (20). In case of doubt ask your movie dealer or one of our servicing centres. In every case quote the make and type of your tape or cassette recorder.

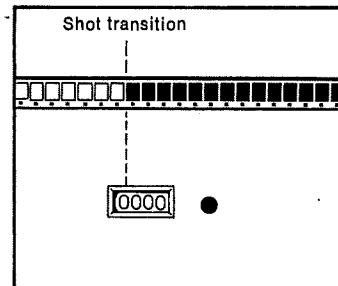

- Link the remote control socket of your recorder and the Auto-start socket (20) of the projector with the starting lead. (The output lead from the recorder must of course also be plugged into the input socket (18) marked D on the projector.)
- Find the shot transition you want and locate it in the film gate with the aid of the inching knob (1). A faint projected image is visible due to the lamp preheating feature.
- Reset the counter (5) to zero by pressing the button to the right of it.
- Adjust your tape or cassette recorder to the exact point where you want to start the recording.

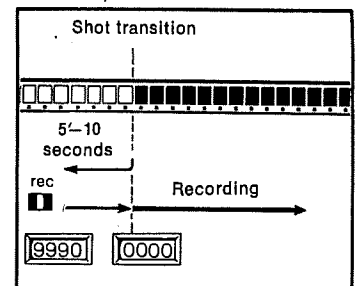

- Let the film run back about 5 to 10 seconds*.
- Press the red recording keys (45), and
- Switch the projector to sound projection \blacktriangleright .
- The tape or cassette recorder starts as soon as the counter reaches "0000"; at the same time the projector starts recording the sound on the film's stripe. [The scale of the recording level indicator (42) lights up.]

Note: If you want to use the Auto-start control without remote starting of the sound source, plug a 6.3 mm (1/4 inch) jack plug into the socket (20) – without that the Auto-start control is not operative.

* With the Auto-start control in operation, recording is suspended while the counter is between "9000" and "0000". Recording can take place with the counter between "0000" and "8999".

Care of the projector

Eumig sound movie projectors require no maintenance, for all moving parts are permanently lubricated. However, dust and film debris deposits in the film path and the film gate could be a nuisance during projection and also cause score marks on your valuable films.

Important: Never touch the rubber linings of the drive wheels (at the left of the projector next to the running speed adjustment) with the fingers, as any grease could here cause uneven running. If necessary clean these linings with alcohol.

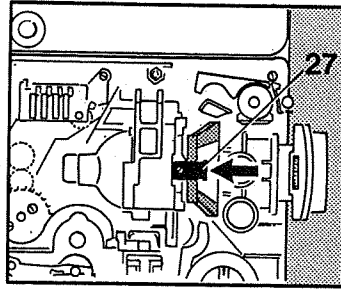

Cleaning the film track

- Disconnect the mains plug.
- Unscrew the fixing screws (8, 48) and remove the front cover.
- Remove the lens (see "cleaning the lens" in next column but one).

Now press the red key (27) in the direction of the arrow and swing aside the film pressure pad to open the film track. Clean the film gate and track with a soft cloth or camel hair brush; remove caked-on deposits with a matchstick (but never with any metal object).

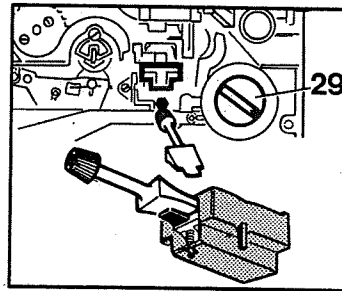

Removing film deposits from the sound head pressure pad

- Disconnect the mains plug.
- Unscrew the fixing screws (8, 48) and remove the front cover.
- Turn the mains switch (4) to "on".
- Turn the selector switch (29) to sound projection $\rightarrow \downarrow$.
- Fit the box spanner supplied as shown in the illustration and turn clockwise as far as it will go.
- Remove the box spanner.
- Pull the pressure pad from its fitting.
- Push the handle of the box spanner into the pressure pad as shown to take up the pressure.

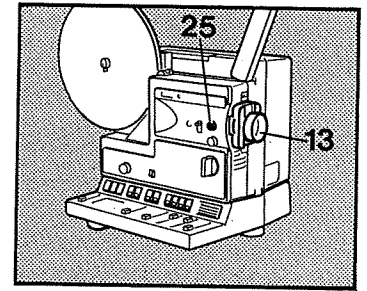

Cleaning the lens

This entails removal of the lens as follows:

- Turn the focusing knob (25) anticlockwise as far as it will go.
- Press the lens (13) inwards.
- Continue turning the focusing knob anticlockwise.
- Remove the lens.

Clean the lens with a soft cloth or camelhair brush. Before replacing the lens check that the engagement key of the lens faces you and that the focusing knob is engaged. Now push the lens fully into the mount and turn the focusing knob (25) clockwise.

After cleaning refit in the reverse sequence.

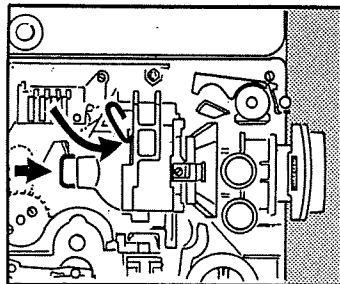

Changing the projection lamp

- Disconnect the mains plug.
- Unscrew the fixing screws (8, 48) and remove the front cover.
- Press down the lamp retaining spring and disengage by swinging to left (top in illustration).
- Remove the lamp and pull off the lamp fitting.

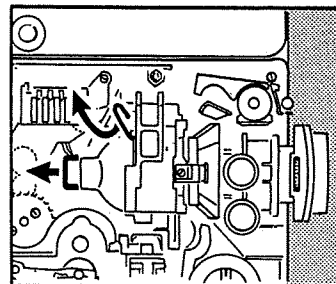

- Replace with a new 15 volt 150 watt tungsten-halogen lamp with diathermic reflector Order No. 790.0410/6. When inserting the new lamp take special care never to touch the bulb or inside of the reflector with the bare fingers. (If you accidentally touch these areas, clean with alcohol.)
- Push the lamp fitting over the lamp base.
- Raise the lamp retaining spring.
- Locate the lamp in its seating so that the centering key of the lamp engages the notch provided for it (top illustration). Be careful not to pinch the lower spring when doing this.
- Re-engage the lamp retaining spring at the top.
- Refit the front cover.

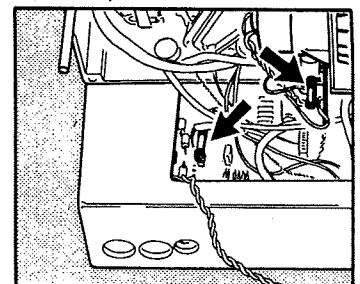

Changing the fuse

Only for the specialist

- Disconnect the mains plug.
- Unscrew the fixing screws (15) of the back.
- Remove the back.

Amplifier fuse :

The fuse is mounted at the left of the amplifier circuit board. Replace with a 3.15 amp slow-blow 5 x 20 mm cartridge fuse, Order No. 0790.308/4 (for USA: 3.2 amp slow-blow No. 0790.309/6).

The fuse protects the amplifier against overloading, but not the projector against damage when connected to a wrong supply voltage.

Fan fuse:

The fuse is mounted at the top on the fan panel (see upper arrow in illustration). Replace by a slow-

General hints

To get the most out of your films for as long as possible treat them from time to time with a film cleaner, available from photographic retailers.

Good sound quality from your magnetic sound films depends on the condition of the projector and the sound film itself. So take special care over splices: These must be clean, precise and preferably within the film thickness, for thickness variations can cause audible clicks on playback.





Fully edit and splice your films before you have then striped. That way you avoid noises at the splices. Be sure to order a high-quality stripe for your films, for instance Agfa F5. To utilise the twin track recording scope of your projector order the film to be provided with a main and a balancing stripe. Preferably store films protected against dust in film cans. Humidifier in the cans prevents the film from becoming brittle.

To make the most of the sound quality of your projector use only high-quality playback units for the sound input.

To utilise the full dynamic range of the projector, connect two external speakers and locate these next to or below the screen during the show.

Apparent troubles may have simple causes

Apparent breakdown or failures may often arise from simple operating faults or minor causes. The examples below are to help you to put things right yourself on the spot.

Problem	Cause	Remedy
Unsteady image, rattling noise	Faulty splice or damaged perforation	Briefly press loop restoring key (10)
Image unsteady and unsharp towards one edge	Film pressure pad loose	Push film pressure pad to left to engage red lock (27)
Film won't thread	Rotary selector switch turned to  from 	Turn rotary selector switch to  from "stop" position
Film emerges from below lens during threading	Film leader not properly trimmed	Turn rotary selector switch to reverse  , cleanly trim film with film trimmer and repeat threading sequence
Cleanly trimmed film still emerges from below lens	Film debris in sound section blocks film	Clean sound section (see page 22)
Weak or uneven illumination of image	Projection lamp not straight in fitting	When inserting the lamp check that it is correctly located: the centering lug of the lamp must engage the cut-out of the lamp support.
No projection light despite lamp in order	Contact problems in lamp fittings; dirty or oxidised pins	Clean contact pins of lamp by repeatedly pulling off and refitting lamp socket
No sound recording	Mixing control turned fully to left	Turn mixing control (36) to "full rec"
Sound recording too faint	Incorrect polarity of re-recording lead	Use Eumig re-recording lead with correct adaptor or resolder connections on plug

Recommended accessories

Daylight Viewer

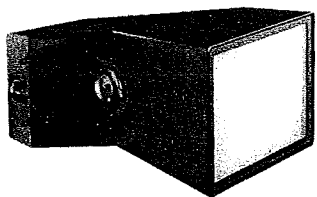

The daylight viewer shows a brilliant image even in daylight on a screen 100 x 75 mm, similar to an animated editing viewer. Simply plug it onto the projector and you can preview your film. The daylight viewer is particularly useful for editing and sound recording.

Order No. 790.0296/1
26

EUMIG Universal Recording Lead stereo

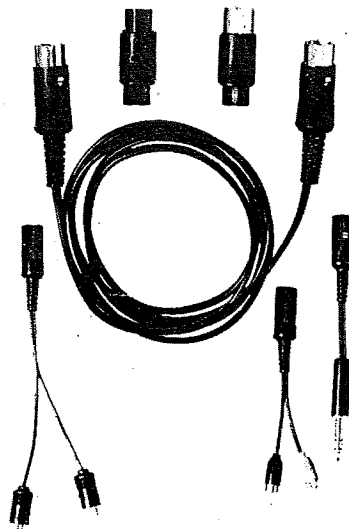

EUMIG helps you to link your EUMIG sound movie projector to any sound source. This is straightforward with EUMIG's Universal Recording Lead including various special adapters. Available from your movie dealer.

Order No. 790.0120/8

EUMIG stereo microphone adapter



The EUMIG stereo microphone adapter makes it possible to connect two mono microphones for a stereophonic recording. The thick section of the cable is for connection to the left channel (main track). This connection is for the EUMIG microphone supplied, which can be remotely controlled.

Order No. 790.0130/0

Auto-start lead



The Auto-start lead permits remote starting of a tape or cassette recorder via the Auto-start control of the projector. One end of the cable carries a jack plug to fit the projector; the other end has bare wire ends for soldering to a plug to fit your tape or cassette recorder. Your movie dealer will be glad to advise you.

Order No. 790.0304/7

Chemo splicer

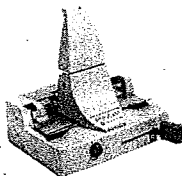

The simplest splicing system ever: The EUMIG Chemo splicer system interlocks the film ends with a serrated edge.

Order No. 781.0020/3

Folding case for Eumig sound projectors

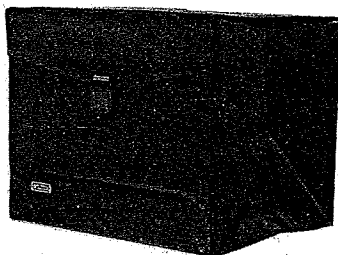

This durable cover protects your projector during storage and has compartments for accessories and films.

Bevel edge splicer

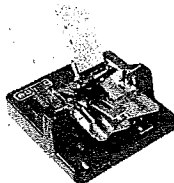

Simple bevel edge splicer for easy

Eumig music and effects record and effects cassette

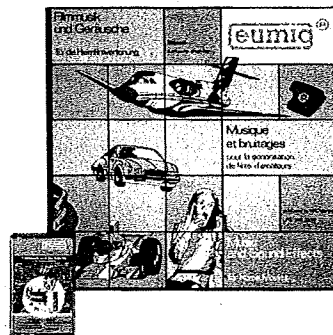

Film music and effects for adding sound to home movies. A wide selection of music sections and everyday background sound effects — the ideal aid for your own sound movie recordings.

Eumig film reels

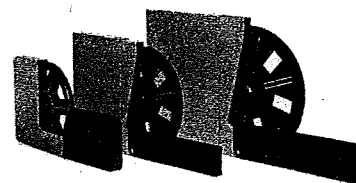

A selection from the wide range of EUMIG reels:

Universal AS 18 take-up and library reels, 120 metres (400 feet); order No. 790.0320/5.

AS 21, 180 metres (600 feet), order No. 596.0270/3.

For both Super-8 and Standard-8 film, boxed EUMIG self-threading reel in library case, 60 and 120 metres (200 and 400 feet) for Super-8 and Standard-8.

EUMIG EUROPA universal reel in library case 60, 120, 180 and 240

Technical Data

Projector

Film gauge
Super-8, Single-8.

Lens
14–30 mm multicoated Eumig
Optical Level System f/1.3.

Lighting system
15 volt 150 watt tungsten-halogen
lamp with diathermic reflector,
preheated to extend lamp life

Mains switch
A green signal lamp and pilot light
show that the projector is switched
on.

Running speeds
18 to 24 fps. continuously variable.

Running counter
Shows film running length in
seconds at 18 fps.

Special features
Longitudinal and lateral levelling
adjustment
Distortion-free optical height ad-
justment on lens
Automatic film threading through to
take-up reel
Provision for daylight viewer
Milled fine focusing knob
max. capacity of reel: 240 m

Weight
Approx. 11kg (24.2 lbs.).

Size
350 x 272 x 304 mm
(13.8 x 10.7 x 11.0 inches).

Sound section

Amplifier
Separate recording and playback
amplifier.
44 transistors, 74 diodes, 1 bridge
rectifiers, 7 operation amplifiers,
7 integrated circuits, 2 integrated
output stages.

Output
2 x 14 watts rms, 2 x 20 watts music.

Frequency range
40–11,000 Hz (18 fps.)

Automatic recording level control
AGFC: Automatic gain and fre-
quency control, covers input level
range up to 50 dB (1 : 300).
Constant sound effect with micro-
phone recordings, irrespective of
speaking distance.

Wow and flutter
Under 0.4%

Signal/noise ratio
Better than 50 dB, weighted accord-
ing to DIN 45 405.

Inputs
Microphone:
0.3–100 mV into 9 kohms
Pins 1 and 2 (mono)
1, 4 and 2 (stereo).

Phono:
50 mV to 3 V into 470 kohms
Pins 3 and 2 (mono)
3, 5 and 2 (stereo).

Output sockets
Two external speaker sockets,
4–6 ohms.
Line output for amplifier, pins 3, 5
and 2, 47 kohms.

Earphone socket
For stereo earphone with 6.3 mm
(1/4 inch) jack plug.

Auto-start socket
Permits a frame synchronized
flying start of a recording by a
link with a tape or cassette recor-
der with remote control provision.

Picture/sound separation
18 frames.

Signals
Green operating signal lamp
Yellow LEDs for operating modes
Red signal lamp for recording mode
Two moving-coil recording level
indicators
Instrument lighting during recording
Yellow signal lamp for mixing.

Special features
Tone control
Twin track recording
Separate manual recording level
control for each channel
Sound recording on film without
light to protect the lamp.
Monitoring during recording also of
parallel track
Remote microphone control during
recording or public address
function
Rapid switch-over to playback
Duoplay automation.
Multiplay; Auto-start control for
sound recording

This apparatus must be earthed.

The equipment should be disconnected from the mains when not in use.

Live parts inside – disconnect from mains before removing the cover.

Important: When operating the projector, do not obstruct the air stream emerging from the ventilation slots.

VALID FOR UK ONLY!

IMPORTANT: The wires in the mains lead are coloured in accordance with the following code:

Green-and-yellow:	Earth
Blue:	Neutral
Brown:	Live

As the colours of the wires in the mains lead of this apparatus may not correspond with the coloured markings identifying the terminals in your plug proceed as follows:

The wire which is coloured green-and-yellow must be connected to the terminal in the plug which is marked by the letter E or by the safety earth symbol  or coloured green or green-and-yellow.

The wire which is coloured blue must be connected to the terminal which is marked with the letter N or coloured black.

The wire which is coloured brown must be connected to the terminal which is marked with the letter L or coloured red.

High Quality Sound

GUARANTEE

HQS means a standard of high sound quality never achieved before on Super 8 film. Every projector is tested by true time analysis.

Eumig guarantees a frequency range for your projector in which the measurement curve lies within the white tolerance field, as shown on this diagram.

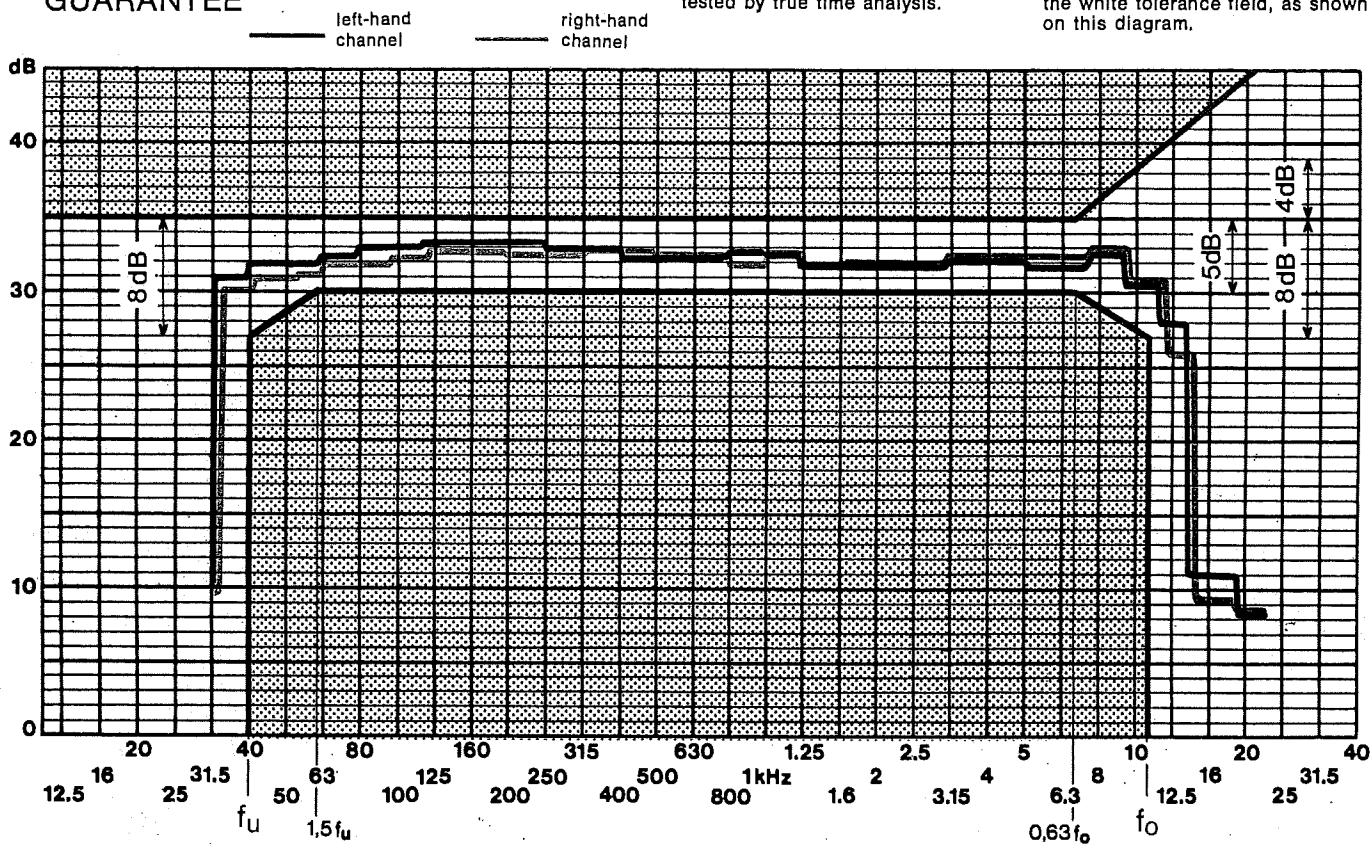

Selector switch set to projection, evaluation via true time analyser, tolerance field according to DIN 15 888.

Subject to design changes without notice. Printed at EUMIG in Austria. 789.9215/9 englisch

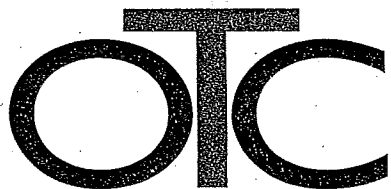

INCORPORATING OLDTIMER CAMERAS