

# FILM-TECH

**THE INFORMATION CONTAINED IN THIS ADOBE ACROBAT PDF FILE IS PROVIDED AT YOUR OWN RISK AND GOOD JUDGMENT.**

**THESE MANUALS ARE DESIGNED TO FACILITATE THE EXCHANGE OF INFORMATION RELATED TO CINEMA PROJECTION AND FILM HANDLING, WITH NO WARRANTIES NOR OBLIGATIONS FROM THE AUTHORS, FOR QUALIFIED FIELD SERVICE ENGINEERS.**

**IF YOU ARE NOT A QUALIFIED TECHNICIAN, PLEASE MAKE NO ADJUSTMENTS TO ANYTHING YOU MAY READ ABOUT IN THESE ADOBE MANUAL DOWNLOADS.**

**[WWW.FILM-TECH.COM](http://WWW.FILM-TECH.COM)**

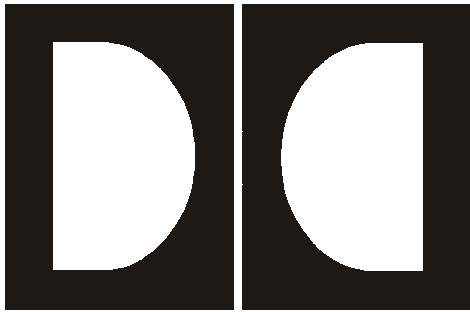

**Dolby**  
**UEX/650 Upgrade Kit**  
**For Model CP650**  
**Installation Instructions**

Issue 1

Part No. 91732



## Dolby Laboratories, Inc.

### Corporate Headquarters

**Dolby Laboratories**

100 Potrero Avenue

San Francisco, CA 94103-4813

**Telephone** 415-558-0200

**Facsimile** 415-863-1373

[www.dolby.com](http://www.dolby.com)

### European Headquarters

**Dolby Laboratories**

Wootton Bassett

Wiltshire, SN4 8QJ, England

**Telephone** (44) 1793-842100

**Facsimile** (44) 1793-842101

**DISCLAIMER OF WARRANTIES:** Equipment manufactured by Dolby Laboratories is warranted against defects in materials and workmanship for a period of one year from the date of purchase. All warranties, conditions or other terms implied by statute are excluded to the fullest extent allowed by law.

**LIMITATION OF LIABILITY:** It is understood and agreed that Dolby Laboratories' liability whether in contract, in tort, under any warranty, in negligence or otherwise shall not exceed the cost of repair or replacement of the defective components and under no circumstances shall Dolby Laboratories be liable for incidental, special, direct, indirect or consequential damages (including but not limited to damage to software or recorded audio or visual material), or loss of use, revenue or profit even if Dolby Laboratories or its agents have been advised, orally or in writing, of the possibility of such damages.

Dolby, the double-D symbol, and Surround EX are registered trademarks of Dolby Laboratories.

© 2000 Dolby Laboratories, Inc. All rights reserved.

Issue 1  
S00/13304  
Part No. 91732

# UEX/650 Upgrade Kit

## Introduction

The UEX/650 upgrade kit converts a Dolby Model CP650D into a Model CP650 with Dolby Digital Surround EX film soundtrack playback capability. See a detailed description of the format at the end of this manual.

In addition, the kit adds digital AES/EBU input signal capability. This input accommodates stereo PCM audio at sample rates of 48, 44.1, or 32 kHz. Jumpers can be set to accommodate an S/PDIF input signal.

The signal input/output 25-pin D-connector is located on the rear panel of the CP650, labeled "Option Card I/O."



**Note:** Your CP650 must be capable of decoding Dolby Digital film soundtracks to play films with Dolby Digital Surround EX soundtracks. If your cinema processor is a Model CP650SR, you must first install a Cat. No. 773 Dolby Digital decoder board. The UD/650 upgrade kit is available for this purpose.

The UEX/650 kit consists of:

- A Cat. No. 794 Dolby Digital Surround EX decoder with AES/EBU input card
- Mounting hardware

## Check CP650 Software Version

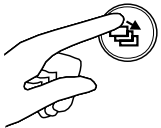
The CP650 operating system software must be version 1.1 or higher. With the CP650 operating normally, follow these steps:

	<p>Press the left <b>menu</b> button multiple times to step through the menus to <b>About this CP650</b>.</p> <p><b>Note:</b> You can also press and hold the left menu button while rotating the front panel fader knob clockwise to step through the menu items.</p>
<div style="border: 1px solid black; padding: 5px; width: fit-content;"> <p>About this CP650: System v. x. x. x. x Cat. No. xyz installed Cat. No. xyz installed</p> </div>	<p><b>About this CP650</b> is made up of three menu screens. The first screen displays the version number of the installed operating system software. If the version reads <b>v 1.0.x.x</b> (x = any number), you must update the software to version 1.1 or higher. Contact your dealer.</p>
	<p>Press the illuminated format button to return to the top menu screen.</p>

## Handling PC Boards

Some steps in this upgrade involve handling printed circuit boards. Many components on the PC boards are very sensitive to static electricity. These components can be destroyed if static charge on your body discharges through the component. You do not even have to touch the component to damage it. Before touching the components or the printed circuit boards, ground yourself by rubbing the frame of the unit with each hand or wearing an earthing strap.

## Installation

1. Remove mains power from the CP650 by unplugging the rear panel power cord.
2. Open the setup control panel access door.

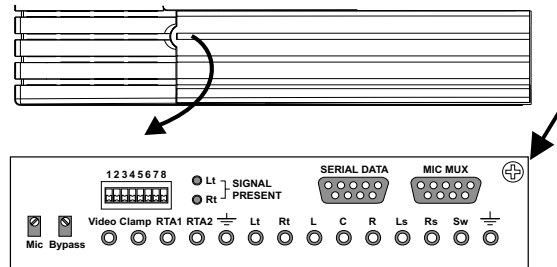

3. Remove the front-panel mounting screw located in the upper right-hand corner of the setup control panel, and carefully pull the front panel toward you to remove it.

4. Remove the seven sub-panel mounting screws and carefully pull the subpanel toward you to remove it. Be sure to support the panel while you perform the next step.

5. Unplug the two ribbon cables connected to the internal circuit boards.

6. Remove the upper circuit board (Cat. No. 774) using the left and right card ejectors. Place the board on a flat surface (for example, on a platter disk). The board should be oriented with the card ejectors close to you.

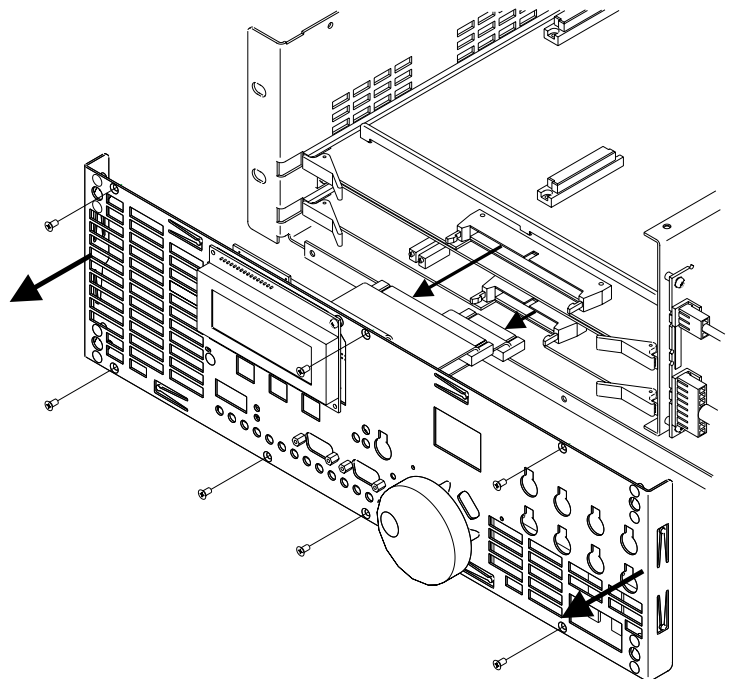

- Remove the Cat. No. 794 upgrade kit board from its anti-static bag and plug it into the **left-hand** side of the main board by aligning the two connectors shown in the figure. Press down on each side making sure the connectors are fully seated. The board can be oriented only one way for the connectors to match.

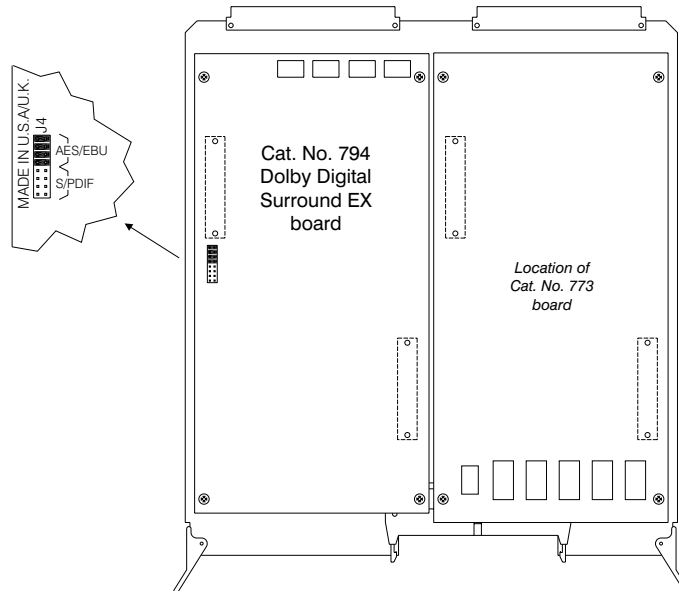

**Note:** The Cat. No. 794 will not function if it is installed in the right-hand location. This area is reserved for the Cat. No. 773 Dolby Digital decoder board.

- Turn over the board combination and install screws through the Cat. No. 774 board and into standoffs at each corner of the Cat. No. 794 board.
- If necessary, set the jumpers to match the type of digital input signal you will use. The jumpers are set to AES/EBU at the factory. A discussion about the digital input types appears on page 6 of this manual.

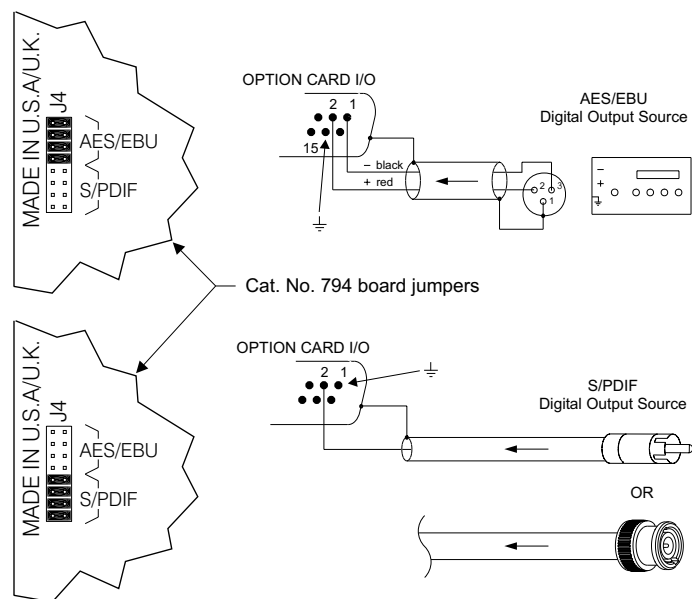

10. Reinstall the assembly into the CP650. Push the board in firmly until it is fully seated.

11. Reinstall the two ribbon cables, inner panel, and front panel.

## Power Amp Connections

With the Cat. No. 794 board installed, the CP650 outputs to all surround channels appear at the **Option I/O Card** connector on the rear panel of the CP650. The Left Surround and Right Surround channel output wiring must be moved from the **Main Audio Output** connector to this connector. **Do not** use the Ls and Rs outputs on the main audio output connector. Additionally, install the wiring for the new back surround channel amplifiers.

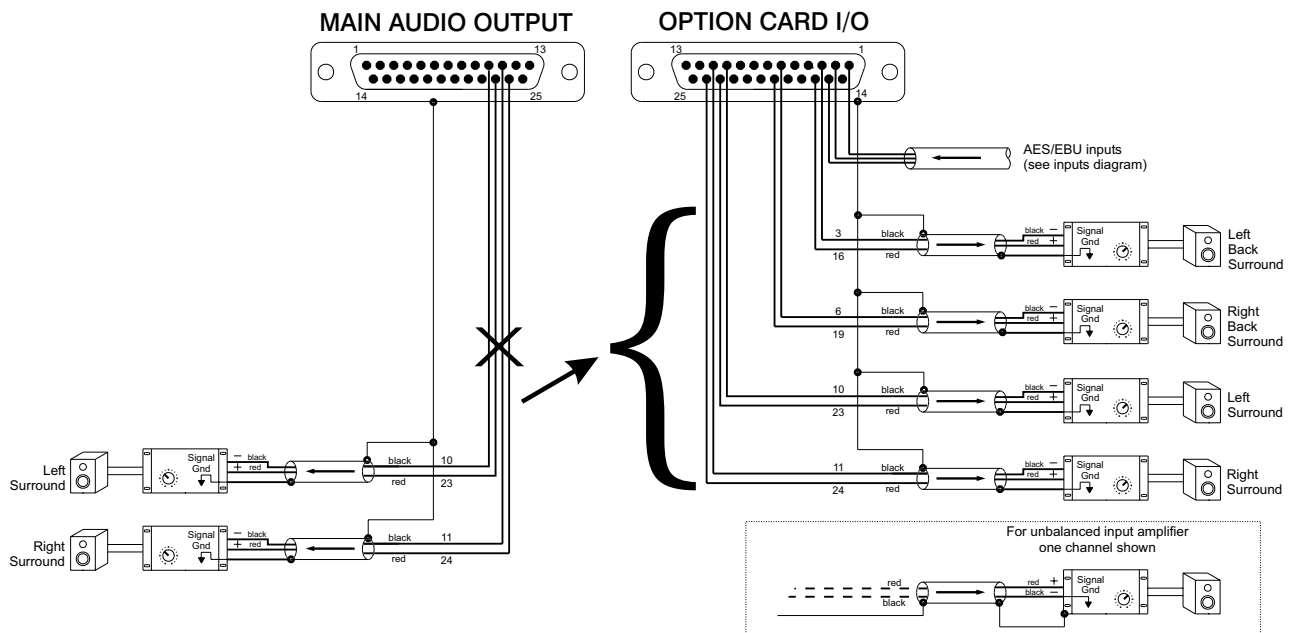

## Alignment

Dolby Digital Surround EX is defined as Format 13. The User 1 (U1) front panel format button was assigned to this format at the factory, and is active when the Cat. No. 794 is installed. If the U1 button was subsequently assigned to a different format, reassign the U1 button (or U2 button) to Format 13.

The CP650 front-panel bar graph display and the PC setup software will now show the additional surround outputs (Bsl and Bsr):

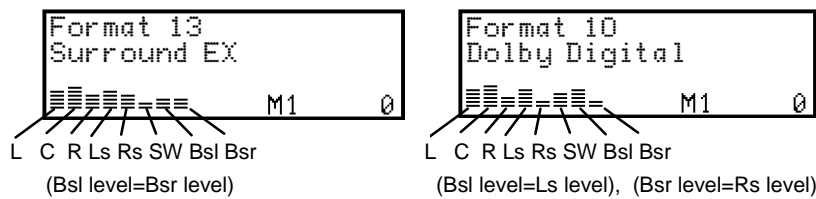

The alignment procedure for the new surround outputs follows the same steps used for the original Left Surround and Right Surround channels during the initial cinema setup. Using the *CP650 Installation Manual*, follow the procedure for microphone placement, RTA hookup, and SPL calibration; then perform level calibration and equalization for all speaker channels:

**Initial Output Level Calibration**—Select and set each main output channel (C, L, and R) to 85 dB, and set each surround output (Ls, Bsl, Bsr, Rs) to 82 dB.

**Coarse (Bulk) Equalization**—Adjust the EQ on all speakers.

**Fine (1/3 octave) Equalization**—Adjust the EQ on all speakers.

**Final Output Level Calibration**—Select and set each main output channel to 85 dB, and each surround output to 82 dB.



## The AES/EBU Digital Input

With a Cat. No. 794 board installed, the CP650 is capable of handling input bitstreams from a digital audio source. Possible digital sources include a CD player, DVD player, satellite television receiver, HDTV receiver, or a HD video player.

### Bitstream Format for the Digital Audio Input

The digital input on the Cat. No. 794 can accept a two-channel PCM (pulse code modulated) bitstream. This is a single bitstream that contains the data for two channels of PCM audio. It can handle sampling rates of up to 48 kHz with up to 24-bit resolution. This bitstream format can be found on the digital output connector of a CD player, DAT recorder, or any basic piece of digital audio equipment.

### Interface Standards for Digital Audio

There are two interface types for digital inputs using copper conductors (non-optical links): AES/EBU and S/PDIF. Even though there are differences in the connectors used and the interface impedance, the format of the bitstream is generally the same. One interface can be easily converted to the other if necessary.

#### AES/EBU STANDARD

The AES/EBU standard has been developed and adopted by **professional audio** equipment manufacturers. The standard defines a balanced input (two conductors plus shield) with a characteristic input impedance of 110  $\Omega$ . Equipment incorporating AES/EBU digital outputs uses conventional-looking XLR connectors carrying digital bitstreams instead of analog audio signals. Most professional audio equipment utilizes this format because balanced operation yields superior noise immunity, just like analog audio. Even in digital audio, noise-free signals are still very important. XLR connectors have been standard on analog audio equipment, and this is another reason for their adoption by the professional audio industry. The cable, however, is specifically designed for digital audio use even though it appears to be the same as that used for analog signals. Any professional audio equipment or broadcast supply company can provide 110  $\Omega$  cable with connectors (or without, if you wish to terminate them yourself). Use of cables not designed for 110  $\Omega$  digital transmission will compromise the integrity of the bitstream and may create an unreliable link between pieces of equipment, particularly with long cable runs.

#### S/PDIF

The S/PDIF interface, an "unofficial" standard, can be found on **consumer** equipment. The interface uses a single-ended input (one center conductor plus shield) with a characteristic input impedance of 75  $\Omega$  and peak-to-peak signal level of 0.5 V. An RCA (phono plug) connector is preferred for consumer equipment such as CD and DVD players. Although S/PDIF-specific cables with connectors can be purchased, good results can be obtained using high-quality 75  $\Omega$  video cables with the appropriate connectors and/or adapters.

**Professional video** equipment uses a variation of this interface, where the P-P digital audio signal is 1V. The decoding circuit handles both levels automatically. BNC (“push and twist”) connectors are used for the digital audio signal on professional video equipment. Like the use of XLR connectors on pro audio equipment, the adoption of BNC connectors for pro video stems from their existing use for the video signal. Again, you can use high-quality 75 ohm video cables with BNC connectors. Alternatively, you can use high-quality RCA (phono plug) video cables with BNC adapters since the cable and impedance are the same.

### Multiple Sources—Conversion Between Interface Standards

If you intend to switch between multiple digital audio sources, DO NOT attempt to convert a digital interface type by directly wiring an XLR connector to a BNC or RCA plug. This will cause an impedance mismatch and signal reflections, resulting in degradation of the digital waveform. It may seem to work, but the results will prove unreliable and dropouts will occur.

With one digital audio input on the CP650, it may seem difficult to switch between multiple units that use different digital output standards. It is actually easy to convert from one interface to the other. A simple and economical method is to use inline transformers. These devices perform the necessary impedance and connector conversion between AES/EBU and S/PDIF signals. With the digital outputs of all units converted to the same interface standard, a patchbay or a router/switcher can be used for selecting which output is connected to the single digital input of the CP650.



The table below shows some examples of AES/EBU ↔ S/PDIF adapters. The S/PDIF connector in these examples is a BNC. BNC-to-RCA adapters can be added to connect to consumer S/PDIF outputs. The units listed below are of the “passive” type.

<b>Adapter Type</b>	<b>Neutrik®</b>	<b>Canare®</b>
Female XLR 110 Ω In to BNC Female 75 Ω Out	NA-BF	BCJ-XJ-TRA
BNC Female 75 Ω In to Male XLR 110 Ω Out	NA-BM	BCJ-XP-TRA

Higher-priced units are available incorporating active circuitry that offer additional features like multiple inputs, inputs for Toslink® (fiber optic) digital connections, and multiple outputs.

## Assign Format 80

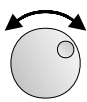
After the connections have been made, the digital input format (Format 80) must be assigned to one of the user-definable format buttons U1, U2, or NS. Using the PC setup software, select Format 80 from the pull-down list for the format button to be assigned, or use the CP650 front-panel menu steps shown below.

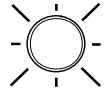
 <div data-bbox="414 660 718 761" style="border: 1px solid black; padding: 5px;"> <p>User Format 2 &gt; Format xx format name</p> </div>	<p>Press the left menu button multiple times to move to the User Format 1, 2, or NS menu. This example shows the U2 button.</p>
 <div data-bbox="470 795 774 907" style="border: 1px solid black; padding: 5px;"> <p>User Format 2 &gt;Format 80 Di gi tal I nput</p> </div>	<p>Rotate the fader knob to select Format 80 from the list. "Digital Input" will display.</p>
 <div data-bbox="478 985 782 1097" style="border: 1px solid black; padding: 5px;"> <p>Savi ng Changes . . .</p> </div>	<p>Press the OK button to save the assignment to the Format button.</p>
	<p>Press the illuminated Format button to return to normal operation.</p>

## About Dolby Digital Surround EX

Dolby Digital Surround EX adds a third surround channel to digital film sound, a concept first envisioned by sound designers at Lucasfilm's Skywalker Sound post-production facility. Jointly developed by Dolby Laboratories and Lucasfilm THX<sup>®</sup>, Dolby Digital Surround EX gives sound mixers a new level of creative freedom.

Dolby Digital Surround EX is fully compatible with all current 5.1 digital sound formats and theatre systems. Prints that use it play normally with current systems, and provide the extra surround channel when played using a CP650 cinema processor equipped with the Cat. No. 794 board, or earlier Dolby cinema processors equipped with the Dolby model SA10 adapter.

It has long been known that a center screen channel is necessary to ensure the precise localization of front sounds for all viewers, including those seated off to the sides. Dolby Digital Surround EX brings similar benefits to the surround sound field. With Surround EX, a back surround channel is reproduced by the speaker array at the back of the theatre, while left and right surround is reproduced by the side arrays. This means that sounds can now be positioned behind the audience, opening the door to exciting new effects, such as true 360° pans.

The back surround channel also makes front-to-back and back-to-front transitions more realistic. Flyovers really seem to pass overhead, rather than down the sides of the theatre. Even ambient sound reproduction is improved, being less affected by the width of the theatre. Equally important, the new back surround channel assures that even viewers seated close to the left or right of the theatre experience the total surround ambience intended by the filmmaker.

The UEX650 kit upgrades the CP650D 5.1-channel digital cinema sound processor to three surround channels that can play digital prints prepared with the Dolby Digital Surround EX process. The installation requires wiring the surround speakers into **left**, **back** (split into two groups), and **right**. Two power amplifier channels are required for powering the two groups of back surround channel speakers. The figures below show the surround signal distribution for conventional 5.1-channel surround and for Dolby Digital Surround EX format.

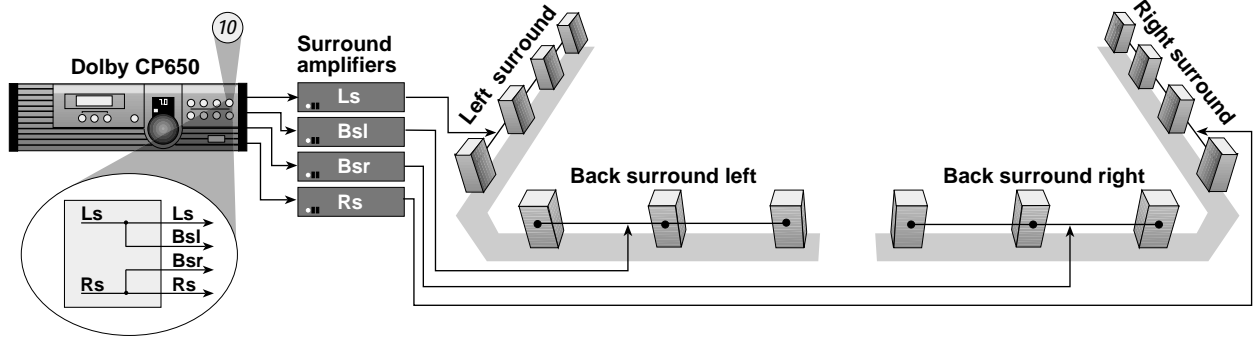

**Dolby Digital 5.1 mode**

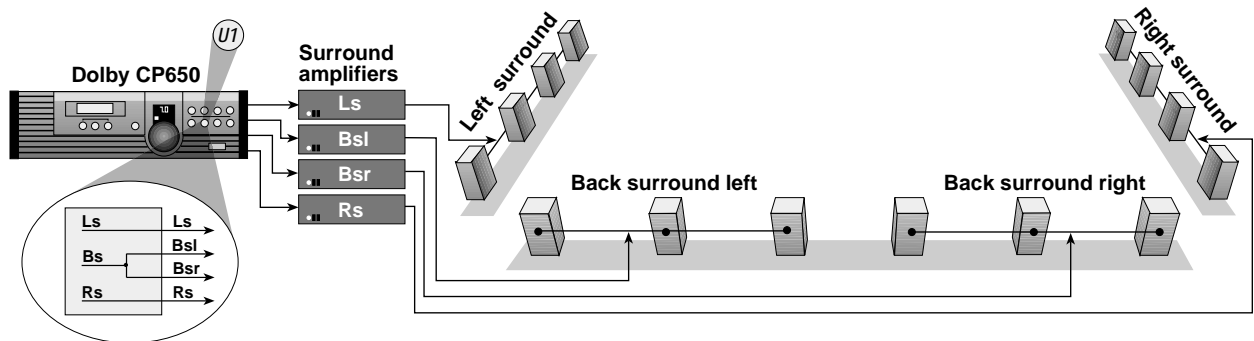

**Dolby Digital Surround EX mode**

# Setup Menu









The *Bsl* and *Bsr* channels shown in italics are available only with Cat. No. 794 installed.

## B-Chain:

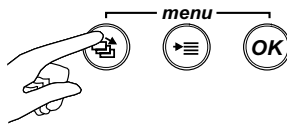
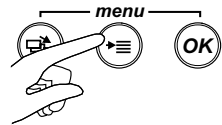
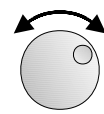
				Notes
	Format and CP650 status display		0–10	Adjust fader. Standard setting is 7.0.
<b>1</b>	Calibrate SPL		45–108.5 dB	Calibrates CP650 internal SPL meter to agree with auditorium sound level meter reading.
<b>2</b>	Output Levels Adjust (initial)	Channel: Level:	L, C, R, Ls, <i>Bsl</i> , <i>Bsr</i> , Rs 1–127 (0.3 dB steps)	Subwoofer level is set in separate menu items.
<b>3</b>	Digital Subwoofer Level Adjust (initial)	Level:	1–127 (0.3 dB steps)	
<b>4</b>	Bulk EQ Adjust	Channel: Bass Adjust: Treble Adjust: Corner Frequency:	L, C, R, Ls, <i>Bsl</i> , <i>Bsr</i> , Rs ± 6 dB ± 10 dB 1, 2, 3, 4 kHz	Set these before adjusting B-Chain EQ. <small>(Fixed at 2 kHz for Ls, <i>Bsl</i>, <i>Bsr</i>, Rs)</small>
<b>5</b>	B-Chain EQ Adjust		Select channel: L, C, R, Ls, <i>Bsl</i> , <i>Bsr</i> , Rs	Press OK to start.
			Select frequency band: 40 Hz–16 kHz	
		+  =	Hold down middle button and turn the knob to adjust level: ± 6 dB in the selected band.	<b>TO EXIT:</b> Press OK to save, then press the Left button to move back to the channel selection menu.
<b>6</b>	Subwoofer EQ Adjust	EQ center frequency: EQ filter width (“Q”): Level Cut:	25–125 Hz 0.5, 1, 2, 4 0 to –12 dB	
<b>7</b>	Output Levels Adjust (final)	Channel: Level:	L, C, R, Ls, <i>Bsl</i> , <i>Bsr</i> , Rs 1–127 (0.3 dB steps)	Final level adjustment after EQ.
<b>8</b>	Digital Subwoofer Level Adjust (final)	Level:	1–127 (0.3 dB steps)	
<b>9</b>	Optical Subwoofer Bandwidth	50 Hz / 100 Hz	50 Hz / 100 Hz	Match SW to LF limit of main screen speakers.
<b>10</b>	Optical Subwoofer Level	Level: Polarity: Center Noise:	1–127 (0.3 dB steps) Normal / Inverse on / off	Perform final <b>level</b> adjustment and <b>polarity</b> check: center noise LF output should decrease when polarity is inverse.

System Software v1.1xx

**A-Chain:**

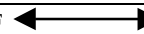
					<b>Notes</b>
<b>11</b>	Automatic Optical Level Adjust, Projector 1				Run Cat. No. 69T test film and press OK. 
<b>12</b>	Automatic Optical Level Adjust, Projector 2				
<b>13</b>	Manual Optical Level Adjust, Projector 1				Run Cat. No. 69T test film and press OK. 
		Left channel / Right channel	Adjust level of selected cell: 0–63 (0.3 dB steps)		
<b>14</b>	Manual Optical Level Adjust, Projector 2				Run Cat. No. 69T test film and press OK. 
		Left channel / Right channel	Adjust level of selected cell: 0–63 (0.3 dB steps)		
<b>15</b>	Optical Focus	Projector: Channel:	P1 / P2 L / R	Adjust lens for max HF.	
<b>16</b>	Automatic Slit-loss Projector 1				Run Cat. No. 69P test film and press OK. 
<b>17</b>	Automatic Slit-loss Projector 2				
<b>18</b>	Manual Slit-loss Projector 1	Channel: Value:	L / R 1–127		
<b>19</b>	Manual Slit-loss Projector 2				
<b>20</b>	Bypass Level Adjust				 Bypass / Normal
<b>21</b>	Optical Surround Level Trim	–3 to +6 dB			Run Cat. No. 151B test film
<b>22</b>	Optical Surround Delay Adjust	20–150 ms			
<b>23</b>	Digital Surround Delay Adjust	20–150 ms			
<b>24</b>	Dolby Digital Reader delay	16–512 perfs.			
<b>25</b>	Nonsync 1 Level Adjust	1–127			
<b>26</b>	Nonsync 2 Level Adjust	1–127			
<b>27</b>	Mono Level Trim	0 to –12 dB			
<b>28</b>	Mono EQ adjust	LF  HF			
<b>29</b>	Preset Fader Levels	Format: Fader level set:	1,4,5,10,11,U1,U2,NS 0–10 or None		
<b>30</b>	User Format 1 select	Select Format to assign to the <b>U1</b> button.			
<b>31</b>	User Format 2 select	Select Format to assign to the <b>U2</b> button.			
<b>32</b>	Non-sync Format select	Select Format to assign to the <b>NS</b> button.			
<b>33</b>	Reversion Mode	Normal / No Reversion	Normal / No Reversion		Recommended for test use only. Resets to Normal after powering on.
<b>34</b>	Noise Gating Active				Special application. For use with RT-60.
<b>35</b>	Clock Set	Hour: Minute:	Set Set		
<b>36</b>	Date Set	Day: Month: Year:	Set Set Set		

# User Menu

1 2 3 4 5 6 7 8



DIP switch 6 DOWN

The options shown in bold are the default settings when the unit was shipped from the factory.

New →

				Notes
	Format and CP650 status display			This is the top-level menu display.
<b>1</b>	Fader Setting	<b>Local</b> /Auditorium	<b>Local</b> /Auditorium	
<b>2</b>	Preset Fader Levels	Format: Fader level set:	1,4,5,10,11,U1,U2,NS 0-10 or None	
<b>3</b>	Auto Dolby Digital	<b>Enabled</b> /Disabled	<b>Enabled</b> /Disabled	
<b>4</b>	Auto Digital Target		Select Target Format: <b>Format 10</b> or Format 13.	
<b>5</b>	Automatic Optical Level Adjust <b>Projector 1</b>			Run Cat. No. 69T test film Press OK to start. Press OK to save.
<b>6</b>	Automatic Optical Level Adjust <b>Projector 2</b>			Press OK to start. Press OK to save.
<b>7</b>	Manual Optical Level Adjust <b>Projector 1</b>		Set level	Press OK to start. Press OK to save.
<b>8</b>	Manual Optical Level Adjust <b>Projector 2</b>		Set level	Press OK to start. Press OK to save.
<b>9</b>	User Format 1 select		Select Format to assign to the <b>U1</b> button	Default is <b>Format 13</b> .
<b>10</b>	User Format 2 select		Select Format to assign to the <b>U2</b> button	Default is <b>Format 65</b> .
<b>11</b>	Nonsync Format select		Select Format to assign to the <b>NS</b> button	Default is <b>Format 60</b> .
<b>12</b>	Mute Fade-in Time		0.2-5 Seconds	
<b>13</b>	Mute Fade-out Time		0.2-5 Seconds	
<b>14</b>	Power-on Format select	Select from Format list or select <b>Last Format</b> used.	Select from Format list or select <b>Last Format</b> used.	
<b>15</b>	Contrast Adjustment		Set the display contrast.	
<b>16</b>	Event Log		Scroll up and down the event listing.	
<b>17</b>	About this CP650, <b>Screen 1</b> <ul style="list-style-type: none"> <li>Control software version number</li> <li>Optional boards installed</li> </ul>			Useful for telephone discussions with your service engineer.
<b>18</b>	About this CP650, <b>Screen 2</b> <ul style="list-style-type: none"> <li>Software module version numbers</li> </ul>			
<b>19</b>	About this CP650, <b>Screen 3</b> <ul style="list-style-type: none"> <li>Network address</li> <li>Board version numbers</li> </ul>			The version numbers are listed for each board in the following order: <b>Cat. No. 772</b> <b>Cat. No. 773</b> <b>Cat. No. 774</b> <b>Cat. No. 777</b> <b>Cat. No. 794</b> "x"= Board not installed
<b>20</b>	Return to the top-level menu display			

System Software v1.1xx