

# FILM-TECH

**THE INFORMATION CONTAINED IN THIS ADOBE ACROBAT PDF FILE IS PROVIDED AT YOUR OWN RISK AND GOOD JUDGMENT.**

**THESE MANUALS ARE DESIGNED TO FACILITATE THE EXCHANGE OF INFORMATION RELATED TO CINEMA PROJECTION AND FILM HANDLING, WITH NO WARRANTIES NOR OBLIGATIONS FROM THE AUTHORS, FOR QUALIFIED FIELD SERVICE ENGINEERS.**

**IF YOU ARE NOT A QUALIFIED TECHNICIAN, PLEASE MAKE NO ADJUSTMENTS TO ANYTHING YOU MAY READ ABOUT IN THESE ADOBE MANUAL DOWNLOADS.**

**[WWW.FILM-TECH.COM](http://WWW.FILM-TECH.COM)**



AUTHORIZED DISTRIBUTOR:  
JARCO INDUSTRIES  
TOLL FREE ORDERING 800-458-7578  
WWW.CONCESSIONSTANDS.COM

Part No. 74745  
Revised May 1997

# *Mighty-Mite Go Anywhere*

Instruction Manual  
Model #2295





 **GOLD MEDAL<sup>®</sup>**

**FUNFOOD EQUIPMENT & SUPPLIES**

Cincinnati, OH 45241-4807 USA

# SAFETY PRECAUTIONS

	<b>⚠ CAUTION</b>
	<p>This equipment is designed and sold for commercial use only. This equipment is not to be used by the consumer in home use. Do not allow direct contact of this equipment by the public when used in food service locations. Only personnel trained and experienced in the equipment operation may operate this equipment. Carefully read all installation instructions before operating the equipment.</p>

	<b>⚠ WARNING</b>
	<p>Always wear safety glasses when servicing this equipment.</p>

	<b>⚠ WARNING</b>
	<p>To avoid serious burns, do NOT touch the kettle while it is hot.</p>

	<b>⚠ WARNING</b>
	<p>Any alterations to this equipment will void the warranty and may cause a dangerous situation. NEVER make alterations to the equipment. Make sure all machine switches are in the OFF position before plugging the equipment into a receptacle.</p>

	<b>⚠ DANGER</b>
	<p>Machine must be properly grounded to prevent electrical shock to personnel. Do NOT immerse the kettle, warmer, or any other part of this equipment in water. Always unplug the equipment before cleaning or servicing.</p>

## NOTE

The information, specifications and illustrations contained in this manual represent the latest data available at time of publication. Right is reserved to make changes as required at the discretion of Gold Medal Products Company without notice.

Your Mighty-Mite Commercial Popper is the finest 16 oz. gas popper built. The kettle is extra heavy, made from a special heat-conducting steel alloy to prevent burnout or warping. Your Mighty-Mite has a heavy duty motor equipped with an extra fan and air tunnel to induce the motor to run cooler during heavy popping conditions.

Read this entire manual before attempting to operate the appliance and keep for future reference. While unpacking your Mighty-Mite, remove all the tape and check for damage that may have occurred during shipping.

## **INSTALLATION**

**IMPORTANT:** When installing and operating your new Mighty-Mite Commercial Gas Popper, you must conform with local codes, or (in the absence of local codes) with the National Fuel Gas Code, ANSI Z223.1-1980.

### **UNIT PLACEMENT**

This unit is certified for use on combustible surfaces. Select a location with a minimum side clearance of 6" and a minimum top, back, and frontal clearance of 30".

### **GAS HOOK UP**

Gas is safe when used properly, but can be very dangerous if used improperly. We suggest installation be performed only by a qualified service person. Gas companies have competent service people to provide safe installation. After installation, all gas connections **must** be checked for leaks using a soap solution.

	<b>⚠ DANGER</b>
	Do NOT use a match or flame to check for leaks. You may cause a fire or explosion!

### **PRESSURE TESTING**

Disconnect the appliance and its individual shutoff valve from the gas supply piping during pressure testing at pressures greater than 0.5 psig (3.45 kPa). Before pressure testing the gas supply piping system at pressures equal to or less than 0.5 psig (3.45 kPa), the appliance **must be** isolated from the gas supply piping system by closing the manual shutoff valve.

When gas connection is complete, wire the unit to the power source which carries the current specified on the unit's data plate. Refer to the wiring diagram located inside the cabinet and in this manual (Drawing No. A-74500 for AC Model; Drawing No. A-74511 for DC Model).

### **ELECTRICAL GROUNDING**

This unit must be grounded in accordance with local codes; or (in the absence of local codes) with the National Electric Code - ANSI/NFPA No. 70-1981. Secure grounded wire to the ground lug found inside the cabinet wiring junction box.

## TYPES OF GAS

The nameplate is marked at the factory to indicate the gas type used, either: "LP" or "propane" for Liquefied Petroleum Gas; or "NAT" or "NG" for natural gas. If necessary, the unit can be altered to change fuels, but we suggest a qualified service person do the alteration. Refer service person to the Maintenance and Repair section of this manual.

## ALTITUDE RANGE

The factory sizes the burner orifices for an elevation up to 2000 feet above sea level. For high altitude operation, please contact Gold Medal Engineering for the proper orifice size.

## GAS PRESSURE

Optimum popping results occur when gas pressure is adequate.

For LP gas, we recommend a pressure setting of 10 inches water column (6 oz. per square inch). For Natural Gas, 4 inches water column (2 oz. per square inch).

The pressure is measured at the appliance while the main burner is lit. A pressure regulator is supplied to deliver optimum pressure for both types of gas if the unit is changed from the original factory specification. Follow the instructions in the Maintenance and Repair section. Be sure properly sized piping is used to supply the needed pressure and maintain adequate gas supply.

	<b>⚠ CAUTION</b>
	Do not store or use gasoline or other flammable vapors and liquids in the vicinity of this or any other appliance.  Instructions on what to do when a user smells gas must be obtained from the local gas supplier and posted in a prominent location near where the unit will be operated.

## LIGHTING

1. Turn the handle of the gas safety valve to "PILOT" position.
2. Push down the red "reset" button; depress the spark igniter. Repeat if necessary until the pilot lights. Once lit, hold the red reset button for about 30-45 seconds or until the pilot remains burning when the button is released.
3. Turn the main handle to "ON" position. The main burner should now ignite from the pilot burner.

## SHUTDOWN

If you want to turn off both the pilot and the main burner, pull the lock on safety and turn to "OFF" position.

## AIR ADJUSTMENT ON BURNER

After main burner is lit according to the directions above, make any needed air adjustments in order to get the best flame. Turn the Air Adjustment Cap to supply more or less air. A blue flame provides optimum heat.

## TO POP POPCORN

Turn the main burner on; pour and spread oil in the kettle. You can let oil heat slightly before adding the popcorn and salt. We recommend 16 ounces of popcorn, 4 ½ ounces of high quality coconut oil, and Flavacol salt to give the best results.

**NOTE:** Oil and Flavacol is the secret to top quality popcorn; popcorn that brings repeat sales. If you are in a commercial pre-pop operation, you can command a higher price. To your customer, it is well worth the slight extra price.

Putting more corn in the kettle will lengthen the popping cycle and decrease overall production. You can make smaller batches, if necessary, but always use a corn to oil ration of 3:1. When using a smaller batch, turn the burner down slightly to prevent it from overheating.

	<b>⚠ CAUTION</b>
	Do not leave main burner in operation when not popping corn.



### IF THE FLAME GOES OUT

	<b>⚠ WARNING</b>
	If pilot is turned off, a five minute shutdown period is required before attempting to relight.

A five-minute shutdown period is required before attempting to relight. First, check to see if you are out of gas. Then verify the thermocouple is in the proper position.

	<b>⚠ WARNING</b>
	<b>At no time</b> during a power failure should an attempt be made to operate this unit. If a power failure occurs during operation, the gas supply is to be turned OFF until power failure has subsided. Then, and only then, should a relight attempt be made per the Lighting and Shutdown Instructions.

## MAINTENANCE INSTRUCTIONS

	<p style="text-align: center;"><b>⚠ CAUTION</b></p> <p>THE FOLLOWING SECTIONS OF THIS MANUAL ARE INTENDED ONLY FOR QUALIFIED SERVICE PERSONNEL WHO ARE FAMILIAR WITH ELECTRICAL EQUIPMENT. THESE ARE NOT INTENDED FOR THE OPERATOR.</p>
	<p style="text-align: center;"><b>⚠ WARNING</b></p> <p>Adequate eye protection must be used when servicing this equipment to prevent the possibility of injury.</p>
	<p style="text-align: center;"><b>⚠ DANGER</b></p> <p>Do NOT immerse the equipment in water. Unplug your machine before servicing.</p>

The DRIVE MOTOR is a sealed bearing type motor that requires no lubrication.

### GAS CONVERSION

1. Disconnect the power supply at the fuse box or breaker.
2. Turn off the gas supply.  
Refer to drawing number D-5019.
3. Place the kettle in dump position. Remove the retainer screws. Remove the burner (Part # 74558) to expose the burner orifice hood. Replace the main burner hood with the appropriate part number for the intended type of gas.  
Part # 74629 (#61) for LP gas      Part # 74630 (#53) for natural gas
4. Replace the pilot burner orifice with the appropriate part number for the intended gas type.  
For Pilot Burner Part # 74028:  
Part # 74029 (.011 dia. holes) for "LP" gas    Part # 74531 (.018 dia. holes) for natural gas  
For Pilot Burner Part # 57031:  
Part # 74029 (.011 dia. holes) for "LP" gas    Part # 74030 (.023 dia. holes) for natural gas
5. Remove the hex cap on the pressure regulator and position the appropriate end of the red plug down. Replace the hex cap.  
**CAUTION:** Orifice hoods and spuds must be screwed tight when LP gas is used.
6. Turn on gas supply and leak test all connections with a soap solution.
7. After the gas supply has been checked, turn on main power.

## **ORDERING SPARE PARTS**

1. Identify the needed part by checking it against the photos, illustrations, or parts list.
2. Please include part number, part name, and quantity needed.
3. Please include model name and machine serial number (located on the machine nameplate) with your order.
4. Address all parts orders to:

Jarco Industries

order toll free 800-458-7578

or order online at [www.concessionstands.com](http://www.concessionstands.com)



# KETTLE CROSS SECTION ASSEMBLY

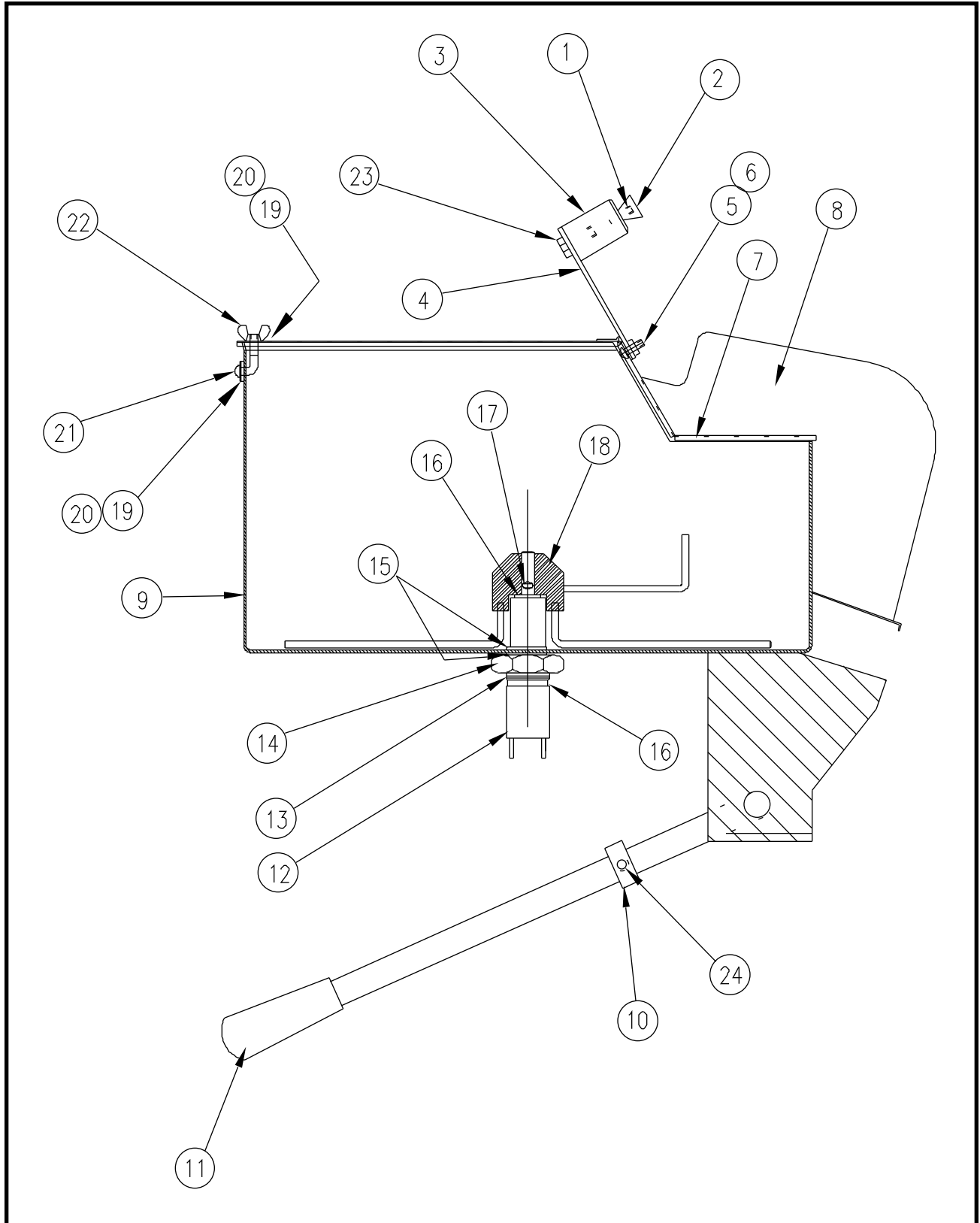

## PARTS LIST – KETTLE CROSS SECTION ASSEMBLY

Item No.	Part No.	Description
1-1	74571	Set Screw, #8-32 x $\frac{5}{8}$ "
1-2	47120	Knob, Lid Lift
1-3	82108	Counter Weight with #8-32 Tap
1-4	74529	Counter Weight Bar, 14 Ounce
1-5	74147	Screw, #8-32 x $\frac{1}{2}$ " Rd. Hd. Ph.
1-6	74146	Hex Nut, #8-32 ESLOK
1-7	74545	Lid Assembly, Welded
1-8	74546	Dump Chute
1-9	74504	Kettle without Agitator and Lid
1-10	74102	Set Collar, Reamed
1-11	41139	Dump Handle, Plastic
1-12	74512	Drive Shaft Assembly
1-13	74513	Kettle Bearing Hub Assembly
1-14	74553	Nut, Hex Jam $\frac{3}{4}$ -16
1-15	74555	Washer, Copper $\frac{3}{4}$ " I.D.
1-16	74554	Thrust Washer, Bronze
1-17	86540	Cotter Pin
1-18	74527	Agitator Assembly
1-19	74088	Seal, Lid Hold Down Screw
1-20	74117	Flat Washer, #8
1-21	74001	Screw, Lid Hold Down
1-22	74574	Wing Nut, #10-24 Nylon Insert
1-23	74520	Hex Head Bolt, $\frac{1}{4}$ -20 x $\frac{3}{4}$ "
1-24	47751	Set Screw, $\frac{1}{4}$ -20 x $\frac{3}{16}$ "

(Items not shown on diagram)

47145	Scoop
47147	Measure, One Cup
47146	Measure, 16 Ounce
47660	Gold Towel
47679	Measure, 14,7cc
74505	Kettle Assembly, Complete
74552	Spring Pin, $\frac{1}{8}$ " x $\frac{3}{4}$ "
47010	Label, Safe Operating Instructions
74510	Shaft, Extension
74631	Label, Do Not Leave Burner
74745	Parts Manual, Mighty-Mite
74575	Tag, Warning LP Gas

# CABINET ASSEMBLY

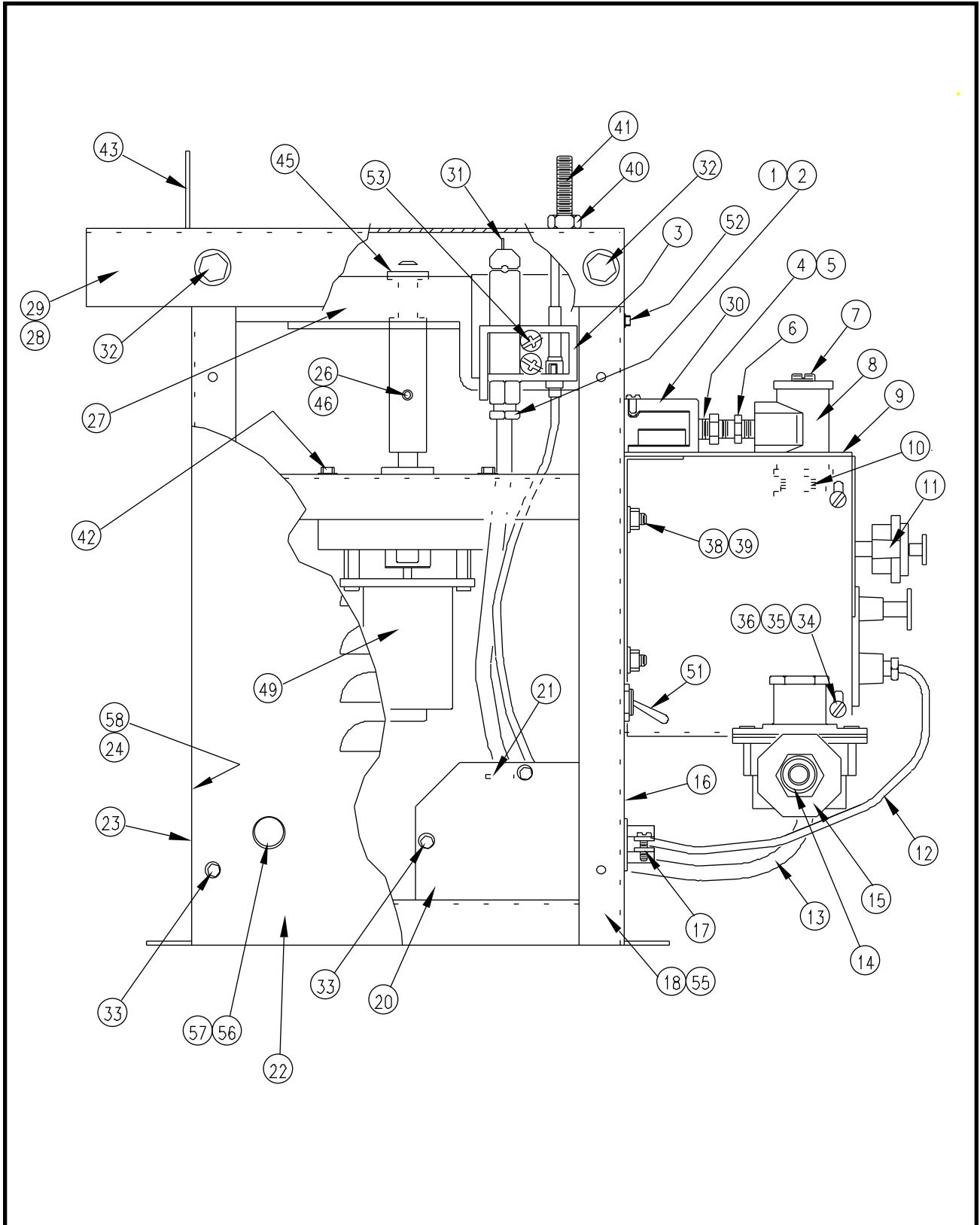

## PARTS LIST – CABINET ASSEMBLY

Item No.	Part No.	Description
2-1	74029	Pilot Orifice .011 LP (Used with P/N 74028)
2-1a	74029	Pilot Orifice .011 LP (Used with P/N 57031)
2-2	74531	Pilot Orifice .018 NAT (Used with P/N 74028)
2-2a	74030	Pilot Orifice .023 NAT (Used with P/N 57031)
2-3	74028	Pilot Burner
2-3a	57031	Pilot Burner
2-4	74629	Hood, Orifice #61 LP
2-5	74630	Hood, Orifice #53 NAT
2-6	74658	Fitting, Orifice Brass
2-7	74562	Brass Pipe Plug, 1/8" NPT
2-8	74560	T-fitting
2-9	74536	Mounting Bracket Regulator
2-10	74559	3/8" Close Nipple
2-11	74027	Gas Safety Valve
2-12	57030	Thermocouple
2-13	74561	1/4" Alum. Tube, 18" Long
2-14	74063	3/8" Brass Street Ell
2-15	74115	Pressure Regulator, NG & LP
2-16	74120	Label, Lighting Instruction
2-17	89045	Strain Relief, T & B #3302
2-18	74543	Mighty-Mite Pedestal Weld
2-19	74116	Label, Ground
2-20	74519	Front Cover Junction Box
2-21	47236	Bushing, Snap #SB-500-6
2-22	74538	Front Cover Plate
2-23	74503	Data Plate - Gas Popper
2-24	74511	Wiring Diagram, 12 Volt
2-25	n/a	
2-26	74551	Extension Shaft Assembly
2-27	74542	Mount Plate, Burner
2-28	74532	Dump Bar Mounting Bracket, L. Side
2-29	74535	Dump Bar Mounting Bracket, R. Side
2-30	74558	Burner, Mighty-Mite
2-31	74515	Shield, Pilot Burner
2-32	74520	Hex Head Bolt, 1/4-20 x 3/4"
2-33	74141	Screw, #8-32 x 3/8" Rd. Hd. Ph.
2-34	74143	Hex Nut, #10-32
2-35	74145	Screw, #10-32 x 1 1/2" Rd. Hd. Ph.
2-36	42302	Washer, #10 Internal Tooth
2-37	n/a	
2-38	74150	Washer, #8 Internal Tooth
2-39	74149	Hex Nut, #8-32
2-40	74133	Hex Nut, 1/4-20
2-41	42153	Set Screw, 1/4-20 x 1 1/2"
2-42	74136	Hex Head Bolt, #10-24 x 3/4"

## PARTS LIST – CABINET ASSEMBLY (continued)

Item No.	Part No.	Description
2-43	74530	Shield, Heat
2-44	n/a	
2-45	46566	Spring Pin, $\frac{1}{8}$ " x $\frac{7}{8}$ "
2-46	42070	Set Screw #10-24 x $\frac{1}{2}$ "
2-47	n/a	
2-48	n/a	
2-49	74576	12VDC Motor
2-50	n/a	
2-51	47201	Switch, On-Off, 12VDC
2-52	74147	Screw, #8-32 x $\frac{1}{2}$ " Rd. Hd. Ph.
2-53	74153	Screw, #8-32 x 1" Hex Hd.
2-54	74633	Ground Lug
2-55	74638	Pedestal Weld
2-56	74636	Fuse Holder
2-57	74637	Fuse 2.5 Amp, 12VDC
2-58	74511	Wiring Diagram 12VDC

# PARTS DIAGRAM - CART

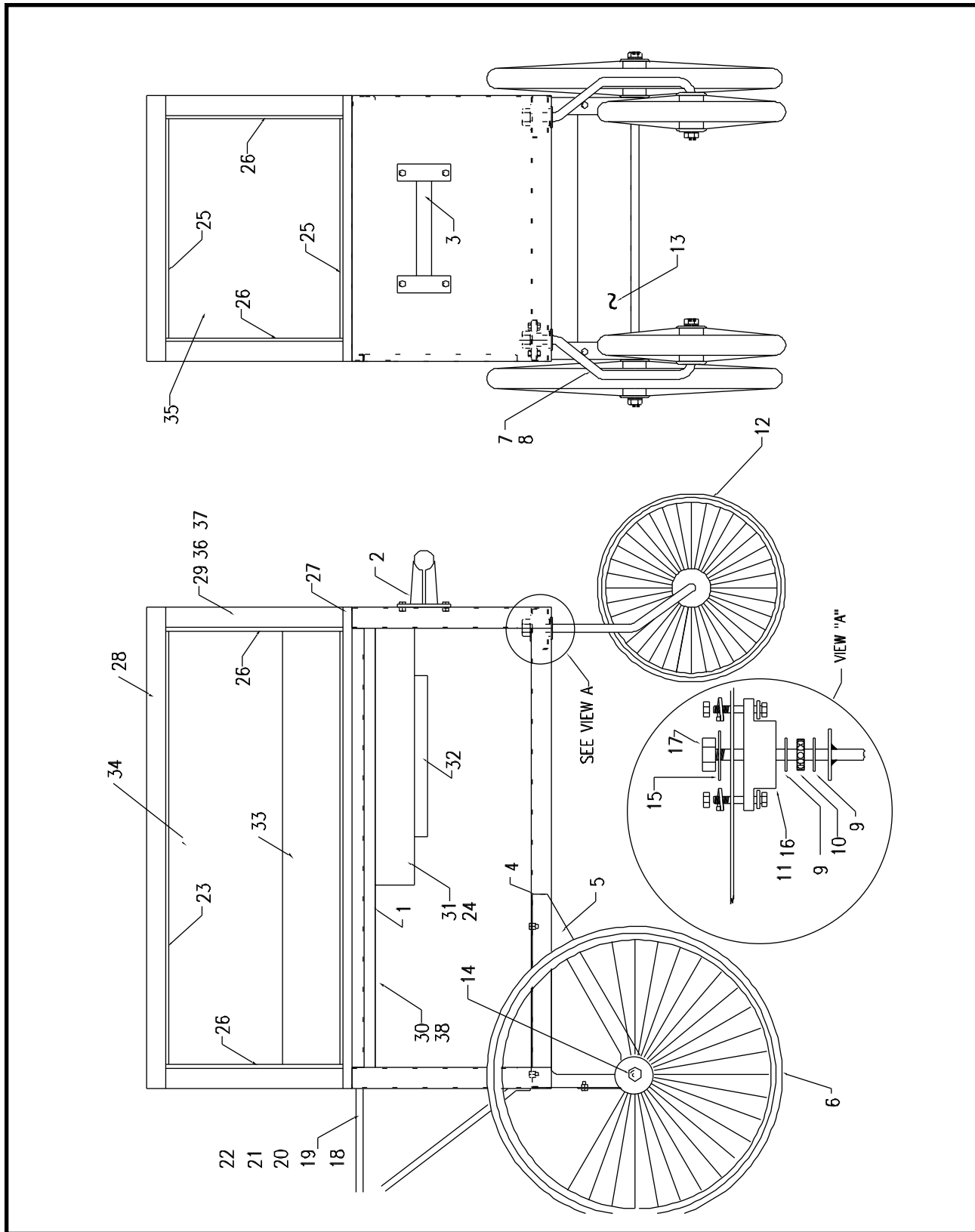

## PARTS LIST – CART

Item No.	Part No.	Description
1	13203	Red Cart Body Assembly
2	47538	Bracket Handle Bar, Gold
3	47530	Handle Bar, Gold
4	54063	Front Axle Mount Bracket, Red
5	54064	Rear Axle Mount Bracket, Red
6	52030	Wheel, 24" Yellow
7	13232	Right Formed Axle Weldment
8	13194	Left Formed Axle Weldment
9	39029	Thrust Washer
10	39028	Thrust Bearing
11	13267	Axle Mount Block with Washer
12	52034	Wheel, 16" Yellow
13	47579	Tie Plate, Red
14	52032	Axle, 5/8" Red
15	77700	5/8" SAE Flat Washer
16	13266	Bronze Bushing
17	46655	Hex Nut, 5/8-18 ESLOK
18	74117	Flat Washer, #8
19	74146	Hex Nut, #8-32 ESLOK
20	74147	Screw, #8-32 x 1/2
21	77496	Shelf, Red
22	77569	Shelf Support, Red
23	41858	Rigid Channel 15 3/8"
26	49509	Glass Channel
27	74565	Bottom Frame Assembly, Gold
28	74566	Top Frame Assembly, Gold
29	74567	Cornerpost, Gold
30	74589	Deck Panel
31	74596	Corn Pan Weldment
32	74668	Old Maid Pan
33	74669	Rear Panel
34	87834	Glass, Front
35	87835	Glass, Side
36	87836	Glass Retainer Strip, Front
37	87837	Glass Retainer Strip, Rear
38	74621	Heyco Bushing, SB-1500-21

## DATAPLATE

PILOT BURNER 57031

"A"	"B"	"C"	"D"	"E"	"F"	"G"	"H"	"I"	"J"
2035BG	115	60	1	3	1.0	PROPANE	2,500	.011	.023
2035DC	12	0C	1	3	0.5	PROPANE	2,500	.011	.023
2035NG	115	60	1	3	1.0	NATURAL	1,000	.011	.023
2035EX	220	50	1	2	0.5	PROPANE	2,500	.011	.023

PILOT BURNER 74028

2035BG	115	60	1	3	1.0	PROPANE	2,500	.011	.018
2035NG	115	60	1	2	1.0	NATURAL	1,000	.011	.018



Mfg. By:  
 GOLD MEDAL PRODUCTS CO.  
 CINCINNATI, OHIO 45214

MODEL	2035	SERIAL No. <small>NEXT CONSEC. NO.</small>	PROD. No. "A"
"B" VOLTS	"C" Hz	"D" PHASE	"E" WIRE
"F" AMPS	"G" GAS	"H" BTU / cu. ft.	<small>CURRENT DATE</small> MFG. DATE

MANUFACTURERS RECOMMENDED	PROPANE NORMAL ALTITUDE	NATURAL NORMAL ALTITUDE	PROPANE HIGH ALTITUDE	NATURAL HIGH ALTITUDE
ALTITUDE RANGE	0-2000 FEET			
ORIF.	BURNER #	61	53	
	PILOT	"I"	"J"	
MANIF. PRESS. WATER COL.	10 INCH	4 INCH	10 INCH	4 INCH
RATED INPUT BTU/HR	12,600	12,500		

GAS-FIRED FOOD SERVICE EQUIPMENT CLASSIFIED BY UNDERWRITERS LABORATORIES INC. IN ACCORDANCE WITH ANSI Z83.14-1980, Z83.14b-1985, GAS COUNTER APPLIANCES.

TESTED FOR USE WITH LIQUID PROPANE AND NATURAL GAS



INTENDED FOR OTHER THAN HOUSEHOLD USE

MINIMUM CLEARANCE FROM COMBUSTIBLE CONSTRUCTION  
 6 INCHES FROM SIDE, TOP, BACK, AND FRONT  
 THIS UNIT IS CERTIFIED FOR INSTALLATION ON COMBUSTIBLE COUNTER



# ELECTRICAL SCHEMATIC

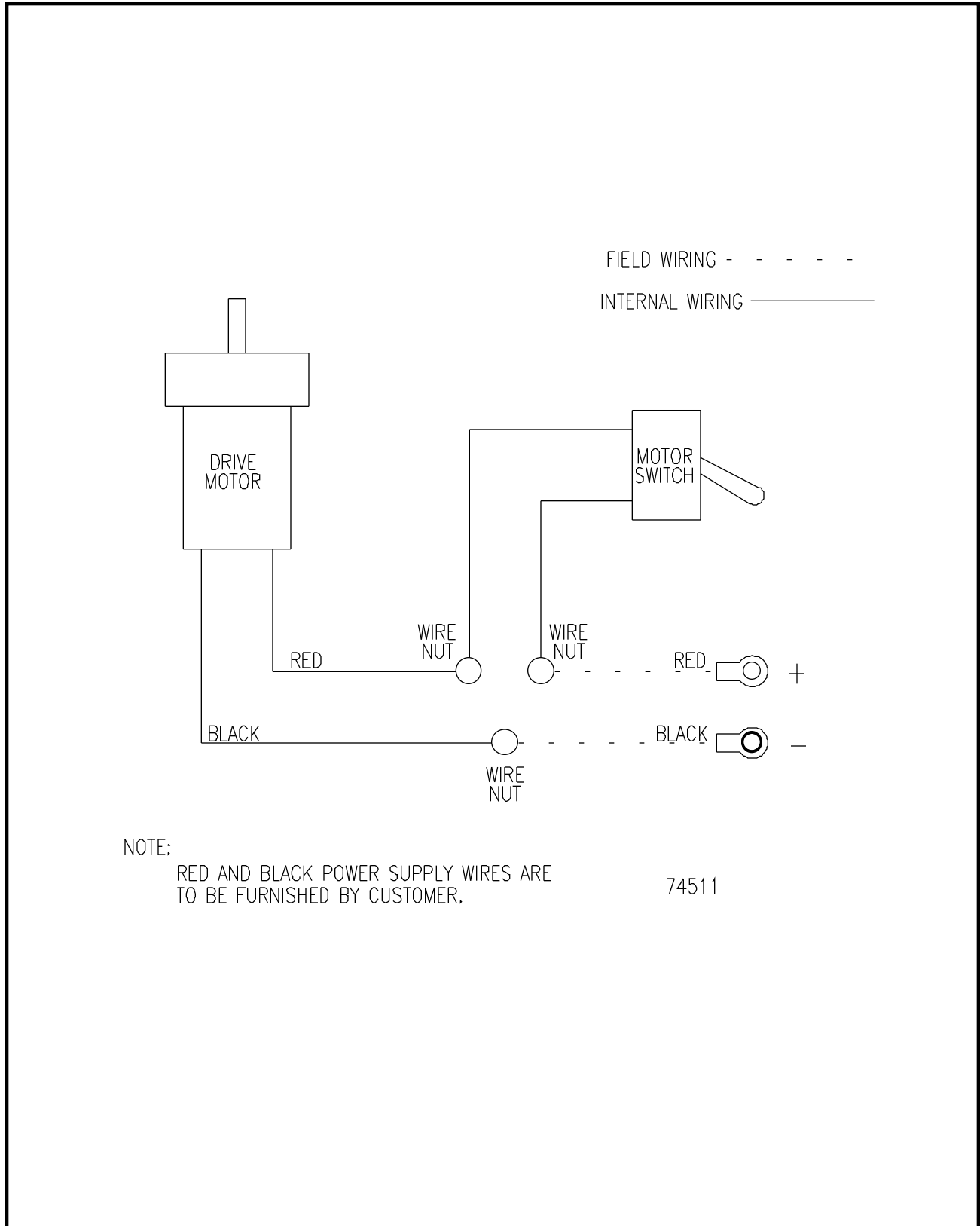

# WARRANTY

WE WARRANT to the original purchaser the Gold Medal equipment sold by us to be free from defects in material or workmanship under normal use and service. Our obligation under this warranty shall be limited to the repair or replacement of any defective part for a period of six (6) months from the date of sale to the Original Purchaser with regard to labor and two (2) years with regard to parts and does not cover damage to the equipment caused by accident, alteration, improper use, voltage, abuse, or failure to follow instructions.

THIS WARRANTY IS IN LIEU OF ALL OTHER WARRANTIES EXPRESSED OR IMPLIED, AND OF ALL OTHER OBLIGATIONS OR LIABILITIES ON OUR PART, INCLUDING THE IMPLIED WARRANTY OF MERCHANTABILITY. THERE ARE NO WARRANTIES WHICH EXTEND BEYOND THE DESCRIPTION ON THE FACE HEREOF. We neither assume, nor authorize any other person to assume for us, any other obligation or liability in connection with the sale of said GOLD MEDAL equipment or any part thereof.

The term "Original Purchaser" as used in this warranty shall be deemed to mean that person, firm, association, or corporation who was billed by the GOLD MEDAL PRODUCTS COMPANY, or their authorized distributor for the equipment.

THIS WARRANTY HAS NO EFFECT AND IS VOID UNLESS THE ORIGINAL PURCHASER FIRST CALLS GOLD MEDAL PRODUCTS COMPANY AT 1-800-428-2676 TO DISCUSS WITH OUR SERVICE REPRESENTATIVE THE EQUIPMENT PROBLEM, AND, IF NECESSARY, FOR INSTRUCTIONS CONCERNING THE REPAIR OR REPLACEMENT OF PARTS.

*NOTE: This equipment is manufactured and sold for commercial use only.*



**GOLD MEDAL PRODUCTS COMPANY**  
**10700 Medallion Drive**  
**Cincinnati, OH 45241-4807 USA**