

FILM-TECH

THE INFORMATION CONTAINED IN THIS ADOBE ACROBAT PDF FILE IS PROVIDED AT YOUR OWN RISK AND GOOD JUDGMENT.

THESE MANUALS ARE DESIGNED TO FACILITATE THE EXCHANGE OF INFORMATION RELATED TO CINEMA PROJECTION AND FILM HANDLING, WITH NO WARRANTIES NOR OBLIGATIONS FROM THE AUTHORS, FOR QUALIFIED FIELD SERVICE ENGINEERS.

IF YOU ARE NOT A QUALIFIED TECHNICIAN, PLEASE MAKE NO ADJUSTMENTS TO ANYTHING YOU MAY READ ABOUT IN THESE ADOBE MANUAL DOWNLOADS.

WWW.FILM-TECH.COM



AUTHORIZED DISTRIBUTOR:
JARCO INDUSTRIES
TOLL FREE ORDERING 800-458-7578
WWW.CONCESSIONSTANDS.COM

Part No. 41490
Revised May 2002

Pop-O-Gold

32oz.

Instruction Manual

Model #2011E

Domestic, Export, Japan





 **GOLD MEDAL**®
FUNFOOD EQUIPMENT & SUPPLIES

Cincinnati, OH 45241-4807 USA

Safety Precautions

	⚠ CAUTION
	<p>This equipment is designed and sold for commercial use only. This equipment is not to be used by the consumer in home use. Do not allow direct contact of this equipment by the public when used in food service locations. Only personnel trained and experienced in the equipment operation may operate this equipment.</p> <p>Carefully read all installation instructions before operating the equipment.</p>

	⚠ WARNING
	<p>Always wear safety glasses when servicing this equipment.</p>

	⚠ WARNING
	<p>To avoid serious burns, do NOT touch the kettle while it is hot.</p>

	⚠ WARNING
	<p>Any alterations to this equipment will void the warranty and may cause a dangerous situation. NEVER make alterations to the equipment.</p> <p>Make sure all machine switches are in the OFF position before plugging the equipment into a receptacle.</p>

	⚠ DANGER
	<p>Machine must be properly grounded to prevent electrical shock to personnel.</p> <p>Do NOT immerse the kettle, warmer, or any other part of this equipment in water.</p> <p>Always unplug the equipment before cleaning or servicing.</p>

NOTE

The information, specifications and illustrations contained in this manual represent the latest data available at time of publication. Right is reserved to make changes as required at the discretion of Gold Medal Products Company without notice.

SPECIFICATIONS FOR POPCORN MACHINES

note: Total height to top of agitator motor is 78 inches.

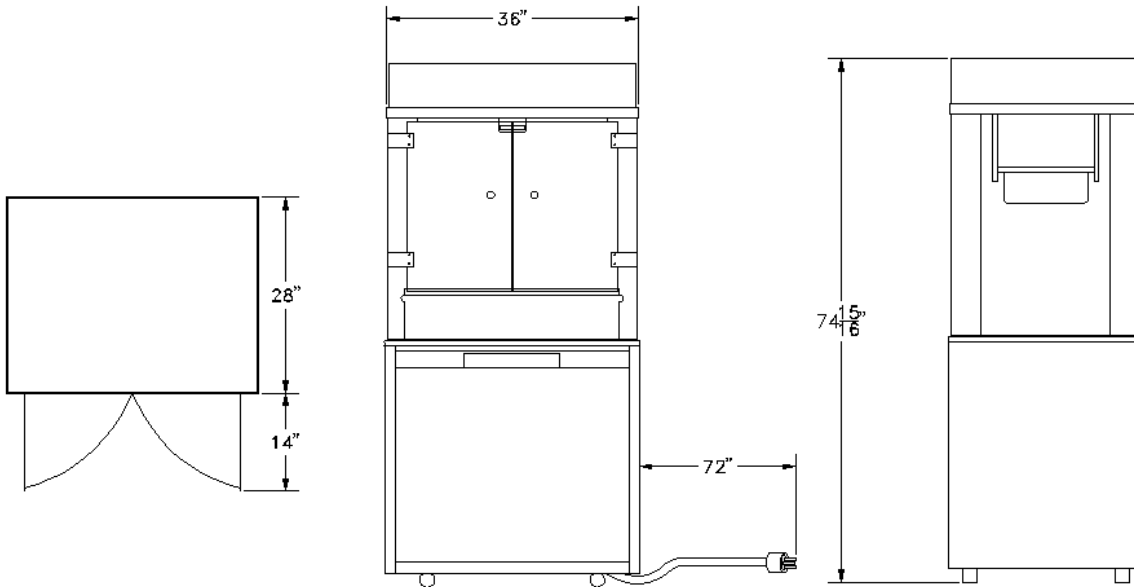

Electrical Specifications:

Domestic: 120/208v or 120/230v 4 wire (2 hot, 1 neutral, 1 ground) 60 Hz.

5760 watts / 24 amps 30 amp plug & receptacle provided (NEMA L14-30P & L14-30R)

Export: 240v, 50 Hz. 5 wire (3 hot, 1 neutral, 1 ground), (2) hot to neutral legs @ 240v are utilized, 5760 watts / 12 amps

Japan: 200v, 50/60 Hz. 2 wire

Agency Approvals: U.L., CUL, NSF, CE

Model Number: 2011E, XE(240v-50Hz.), JXE(200V)

Options: B(includes Base), D(deep well corn storage),
N(neon "Popcorn" sign)

Oil Delivery System: All Pop-O-Golds are equipped with provisions for either the Bucket Pump System (2114) or the Bag-in-a-Box System (2257H).

Lighting: All models are available with either an illuminated red & white "popcorn" sign or a Neon sign with red "popcorn" and yellow "puffs" on each end. All domes are reversible for front or back counter.

INSTALLATION INSTRUCTIONS

CHECKING SHIPMENT

Unpack all cartons and check thoroughly for any damage that may have occurred during transit. Damage claims should be filed immediately with the transportation company.

Domestic models only: 120v/208v or 120v/240v 60 Hz.

A 30 amp – 4 wire wall receptacle is shipped with each machine. This receptacle will accept the attachment plug on the popper and must be used. Your electrician must furnish sufficient current for proper operation of your machine. We recommend this popper be on a dedicated and circuit protected line. (note: The Pop-O-Gold “uses” both “hot to neutral” legs, 120v. The machine does not “use” the 208v or 240v, “hot to hot” connection.

	⚠ DANGER
	<p>Machine must be properly grounded to prevent shock in case of electrical problems.</p> <p>Wall receptacle must be wired as shown on the receptacle.</p> <p>Failure to wire properly will void the warranty and can result in damage to motors, elements, relay, lights, etc.</p>

FINAL PREPARATIONS

⚠ WARNING

<p>To avoid serious burns, do NOT touch the kettle while it is hot!</p>

The popcorn machine was adjusted, inspected, and tested before it left the factory. After the machine has been installed, mount the kettle assembly in the hanger arms and plug in the kettle lead-in cord. Tighten the ring on the kettle lead-in plug.

Connect the clear oil line from the pump to the aluminum line from the popper with the supplied hose clamp. Connect the 6 pin connector from the popper to the receptacle on the oil pump. Both Bucket pump (2114 or 2114EX) and Bag-in-a-Box pump (2257H or 2257HX) have the same receptacle.

Follow the instructions provided in the oil pump manual to set the oil delivery amount. The proper amount of oil for the 32oz. Pop-O-Gold is between 8oz. to 9.6oz.

To check for proper amount of oil, and assure oil is liquid, dispense a “shot” into a measuring cup.

OPERATING INSTRUCTIONS

CONTROLS AND THEIR FUNCTIONS

LIGHT SWITCH

Operates on all the lights, interior and dome, on your popcorn machine.

WARMER SWITCH

Operates the blower and warmer in the corn storage area, keeps popped corn warm.

KETTLE HEAT SWITCH

Operates the heating elements in the popping kettle.

KETTLE MOTOR AND EXHAUST SWITCH

Operates both the kettle agitator motor and the exhaust blower. The exhaust blower is only required when popping corn.

OIL SYSTEM MASTER SWITCH

Sends power to the oil pump, either the Bucket Pump or Bag-in-a-Box models. The warmer/blower on the oil pump is activated. The warmer/blower on the oil pump will keep coconut popping oil liquid if the doors on the base are kept closed. It may be desirable to keep this switch on at night, if you have problems keeping the coconut oil liquid. Coconut oil will congeal at temperatures below approximately 76° F [24° C].

“RED” OIL DISPENSE MOMENTARY SWITCH

When pushed, will dispense the predetermined amount of oil into the kettle.

YELLOW LIGHT & AUDIBLE SIGNAL (LOAD – DUMP)

Alerts the operator to:

1. Load the corn and oil *or*
2. Dump the popped corn from the kettle *or*
3. Turn off the kettle heat switch if they are done popping corn



POPPING CORN

1. Turn on all Switches.
2. When popping with coconut oil, be sure the oil is liquid. Dispense oil into a measuring cup first then use that oil for the first popping cycle.
3. When the kettle is ready (about 5-8 minutes), the Yellow Light and Audible Signal turn on. Lift the kettle lid and pour in 32 oz. of corn (use the supplied corn cup) and 8 teaspoons (21 cc) of Flavacol. Close lid.
4. Press the RED oil pump button. The proper amount of oil is pumped into the kettle. The Light and Signal will turn off.
5. When the popcorn has completed popping, the Light and Signal will turn on. Dump the Popcorn.
6. On the final kettle of corn, turn the "KETTLE HEAT" switch off, just as the lids are forced open by the popping corn. This saves electricity, and helps eliminate smoke and odor after you have stopped popping.

REMEMBER:

If the kettle heat switch is turned on and the Signal is sounding *one of the* following actions should be taken:

4. Load the corn and oil *or*
5. Dump the popped corn from the kettle *or*
6. Turn off the kettle heat switch if you are done popping corn

When you are finished popping, make sure "KETTLE HEAT" and "KETTLE MOTOR" switches are turned "OFF".

NEVER LEAVE THE HEAT ON WHEN YOU ARE NOT POPPING.

CLEANING INSTRUCTIONS

DAILY:

Clean the Kettle

1. As you pop corn, wipe the kettle with a clean cloth. It is easy to keep the outside clean when the kettle is warm and the oil is not baked on. **CAUTION:** The hot kettle will cause burns if you touch it with your hand.
2. Every night, mix a gallon of Heat'n Kleen solution (2 tablespoons per gallon of water). Turn on the kettle heat. When the water starts to boil, turn off the heat and let it work overnight.
3. The next morning, dump the solution in a bucket and wipe the inside of the kettle with a cloth.
4. A CLEAN-IN-PLACE hook is located behind the operator side kettle support arm. Just tilt the kettle to the dump position, and swing the hook into position to hold the kettle in the dumped position. This feature will help you clean the kettle.

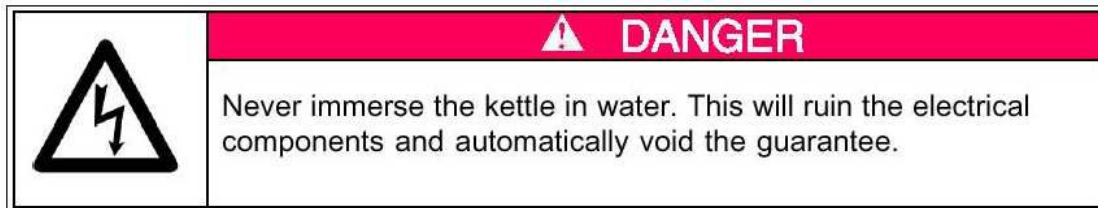

Clean the Popcorn Machine

1. Wipe the stainless steel parts with a clean cloth and cleaner designed for stainless steel. **Do not use oven cleaners, as they will damage parts of the machine.**
2. Remove and clean the 1st stage mesh filter. Cover removal not required. Clean filter in warm soapy water.
3. Ammonia cleaners will damage the plastic doors. Use only non-ammonia cleaners.

WEEKLY:

Clean the filters in the popcorn machine

1. Loosen the 2 screws (no tools required), on the filter cover plate on the ceiling inside the popper. Remove the cover, the bag and mesh filters. Clean the bag filter and the mesh filters in warm soapy water. Let dry overnight and reinstall.
CAUTION: Keeping the filters clean is important to let the exhaust system "do its job".
2. Check the condition of the clear oil lines and tighten or replace as required.

Item No.	Part No.	Description
1	41250	Metal mesh filter
2	41169	Oil Mist Bag Filter

MAINTENANCE INSTRUCTIONS

	⚠ CAUTION
	<p>THE FOLLOWING SECTIONS OF THIS MANUAL ARE INTENDED ONLY FOR QUALIFIED SERVICE PERSONNEL WHO ARE FAMILIAR WITH ELECTRICAL EQUIPMENT. THESE ARE NOT INTENDED FOR THE OPERATOR.</p>
	⚠ WARNING
	<p>Adequate eye protection must be used when servicing this equipment to prevent the possibility of injury.</p>
	⚠ DANGER
	<p>Do NOT immerse the kettle, warmer, or any other part of this equipment in water. Unplug your machine before servicing.</p>

TROUBLESHOOTING

LONG POPPING CYCLES

If your pop cycle is longer than 4 minutes, it can be the result of several things:

- A. **HEATING ELEMENT** - One of the heating elements in the kettle may be burned out. This would result in the kettle never reaching the proper operating temperature.
- B. **LOW VOLTAGE** - If the machine is operated on low voltage, this could cause the kettle not to reach the proper operating temperature. Voltage for each leg, with kettle turned on, must be at least 110v.
- C. **INADEQUATE SUPPLY LINES** - Inadequately sized electrical supply lines, in addition to being a fire hazard, would also prevent the kettle from reaching the proper operating temperature. Check with a qualified electrician.
- D. **INFERIOR CORN** - Inferior quality corn would result in longer popping cycles. Use only top quality hybrid popcorn from reputable suppliers. Even then, if you let your corn pick up moisture or dry out, your popping cycles will be slow.

TROUBLESHOOTING

KETTLE DOES NOT HEAT

Before you go any further, make sure the kettle lead-in cord is plugged in, and that circuit breakers are not tripped. Make sure all electrical connections are tight.

- A. KETTLE HEAT SWITCH - Check the voltage to and from the "KETTLE HEAT" switch, and if the switch is defective replace it.
- B. CONTROL - A defective thermocouple lead will cause the kettle not to heat. Check for good connections from the kettle to the control.
- C. MAIN RELAY

MOTOR WILL NOT TURN AGITATOR

WARNING! If the kettle agitator shaft is not rotating, do not Pop corn.

Adjust the clearance between the kettle bottom and the stir blade to 1/32". (use a dime)

Loosen the set screw in the collars above and below the crossbar and adjust the agitator shaft as necessary. Then re-tighten the set screws in the collars.

OIL PUMP DOES NOT DELIVER OIL TO KETTLE

If the pump is operating but oil is not dispensed, the oil may be solid in the oil lines. If the pump is not operating see the pump manual for instructions.

REPLACING BROKEN GLASS

Should you accidentally break a panel of glass, it can be replaced very easily without disassembling the popper. 1. Remove all loose pieces of glass.

2. Unscrew the glass retaining strips.

3. Remove all rigid glass channels from around the glass to be replaced. Set it aside as it must be reused.

4. Carefully remove the rest of broken glass.

5. Apply decals to the new glass panel.

6. Slide rigid glass channels over the exposed sides and bottom. Maneuver the new glass into position.

7. Replace glass retaining strips using the same screws you removed earlier.

NOTE

We do not ship glass. Obtain from local glass shop or hardware store. Always purchase double strength type glass.

Glass Size: (Front) 31 ¹/₁₆ " X 32 ³/₁₆ " X 1 ¹/₈ "
(Sides) 23 ¹⁵/₁₆ " X 33 ³/₁₆ " X 1 ¹/₈ "

This section describes the Electronic Temperature Control on your 32oz. Pop-O-Gold. The temperature of the popcorn kettle is controlled by an Electronic Control. Mechanical high limit thermostats are still used as a limit control. This model is also equipped with a pulsing buzzer and Yellow light that signal when the kettle heat switch is on but the kettle is at or over the temperature set point.

Operation

The control is factory set to 412F – 415F which stops power to the kettle when the thermocouple reaches 412F – 415F. On the Pop-O-Gold machine, this is also the ideal point to dump the popped corn out of the kettle. On the first start-up this is also the ideal time to load the corn and oil. Therefore if the kettle heat switch is turned on and the buzzer is sounding *one of the* following actions should be taken:

- Load the corn and oil *or*
- Dump the popped corn from the kettle *or*
- Turn off the kettle heat switch if you are done popping corn

Adjustment of Electronic Control

If you would like to have the buzzer sound sooner or later than the factory setting, adjust the temperature setting as follows:

1. To sound the buzzer sooner, lower the temperature setting. A change of 3 to 6 seconds can be achieved with a change in temperature of 5 to 10 degrees.
2. To sound the buzzer later, raise the temperature setting.

The Electronic Control is located under the dome facing the operator on the left side. A calibrated dial is located on the control for this purpose.

Adjustment of Buzzer Sound Level

If you would like to adjust the buzzer volume, turn the baffle on the buzzer. The buzzer is located under the dome facing the operator.

1. If the kettle does not heat and the buzzer sounds continuously, then one of the following has happened:
 - a. The kettle plug is not tightened completely to the receptacle
 - b. The thermocouple wire is loose or broken.
2. If the kettle heats but the popping cycle is very long, check for a defective high limit thermostat. (buzzer operates normally)
3. If the kettle is popping normally but the buzzer does not sound, check for a defective buzzer.
4. **Caution:** If the kettle pops too quickly, and the buzzer does not sound, **do not continue popping corn**. Check for a loose thermocouple in the kettle. It is also possible the thermocouple leads are “switched” from the correct polarity. (See note 2 below)
Either situation will result in the control to “ask” for more heat and the kettle will operate on the high limit thermostats.

Notes:

1. Do **not** adjust the (3) potentiometers on the electronic control. If adjusted, the performance will be erratic and could result in an over temperature condition. The only adjustment is described on page 1.
2. Thermocouple wire consists of (2) different wires made of different materials that are color-coded have a polarity. It is important that red (-) is connected to red (-), and yellow (+) is connected to yellow (+), at the lead-in plug, the receptacle, and at the electronic control. Note that the red lead is magnetic if you have trouble determining which is which. If switched, the control will not operate.

HOW TO ORDER REPAIR PARTS

1. When ordering parts, include part number, part name, and quantity required.
2. Include the Model Number and machine serial number (found on nameplate) with your order.
3. Address orders to:

Jarco Industries

order toll free 800-458-7578
or order online at www.concessionstands.com

			issue date:	10/1/99
			revised:	12/01
<i>Model Number:</i>	2011E-	2011XE-	2011JXE-	
<i>Description:</i>	32oz. Pop-O-Gold	Export 240v	Japan 2 Wire 200v 50/60 Hz.	
<i>Manufactured:</i>	3/1/1999 to Current	3/1/1999 to Current	6/1/2001 to Current	
<i>Wiring Diagrams (standard models):</i>	D14037S1 (120V)	D14069S1 (240V)	D14036S8 (w/2114EX) or S9(w/2257H) (200V)	Neon or Fluorescent Domes
<i>Wiring Diagram Flexi-Pop</i>	D14037S4 (120V)			
<i>Wiring Diagrams Salt/Sweet Switch:</i>		D14069S3 (240v)		Neon or Fluorescent Domes
<i>Electrical Requirements:</i>	120/208v or 120/230v, 60 Hz. 4 wire (2 hot, 1 neutral, 1 ground)– 5760 watts/24 amps actual, NEMA L14-30P plug/L14-30R receptacle			Domestic Models
	240v, 50Hz. 5 wire (3 hot, 1 neutral, 1 ground) – 240v hot to neutral 5760 watts/12 amps			Export Models
	200v. 50/60 Hz., 3 wire, (hot, neutral, ground)			Japan Models
<i>General Info.:</i>	32oz. Hanging Steel Kettle, with plug & receptacle			
	Kettle is removable but use clean-in-place latch for cleaning			
	Counter or Stainless Steel Base (base is 2009SS)			
<i>Major Changes:</i>				
Mar-1999	Changed to electronic heat control for kettle. Service Bulletin 21			
		Kettle with Mechanical Thermostat (parts still available)	Kettle with Electronic Control	
	Complete Kettle	2027	2027E	
	Kettle Bottom Assembly	41548	41548E	
	Kettle Lead Assy.	61082	48290	
	Wiring Diagram	C12338	See above	
	Control Thermostat	82427	none	
Sept.-1999	New neon supplier. Projected neon design is discontinued. (parts still available)			
	Yellow Puff Neon Tube	41563		
	Red "Popcorn" Tube	41564		
Jan.-2001	Kettle temperature control changed from 82699 to 48664. Directly interchangeable.			

Electrical Components Under Dome

Part Number	Description	Part Number	Comments
120V	<i>DOME WITH LIGHTED "POPCORN" SIGN</i>	240V	
41507	FLOURESCENT LIGHT TUBE - 25WATT 33 INCH	41507	Domestic, 240v export and Japan
41020	LIGHT TUBE HOLDER	41020	Domestic, 240v export and Japan
41021	STARTER HOLDER	41021	Domestic, 240v export and Japan
41506	GLASS "POPCORN" SIGN	41506	Domestic, 240v export and Japan
41508	FLOURESCENT STARTER - FS25	41508	Domestic, 240v export and Japan
41509	LIGHT BALLAST	41510	Japan 200v, 50/60 Hz. Ballast is 48708
120V	<i>DOME WITH NEON "POPCORN & PUFFS"</i>	240V	
67432	NEON SIGN ASSEMBLY (2 3/4" DEEP)	67432	Oct 1999 to present
38526	NEON SIGN ASSEMBLY (2 1/4" DEEP)	38526	Service only – April-Oct. 99
67445	TRANSFORMER FOR NEON SIGN	67445	Domestic, 240v export and Japan
120V	<i>ELECTRICAL PARTS MOUNTED TO TOP OF MOTOR PLATE UNDER DOME</i>	240V	
41015	EXHAUST BLOWER -UNDER DOME	41965	
46081	30 AMP RELAY - UNDER DOME	89858	
61154	AUDIBLE ALARM - FOR DUMP SIGNAL	61154EX	
48664	ELECTRONIC CONTROL	48664	
41449	KETTLE DRIVE MOTOR	41500	
47047	RECEPTACLE FOR 175 WATT HEAT LAMP	47047	
48018	FAN – 5 3/4" SQUARE "COOLING" FAN	48037	
47208	TERMINAL BLOCK	47208	
48578	THERMOCOUPLE LEAD – CONTROL TO RECEPTACLE	48578	
41516E	KETTLE RECEPTACLE	41516E	
	EXPORT STEP DOWN TRANSFORMER- 240 to 120v	67509	Also used for Japan without BIB Oil System
Part Number	Description	Part Number	Comments

120V	<i>ELECTRICAL PARTS MOUNTED TO TOP OF MOTOR PLATE UNDER DOME (CONTINUED)</i>	240V	
48590	120 vac Relay DPST – normally open		Flexi-Pop only
48645	120 vac Relay DPDT		Flexi-Pop only
48710	120-12 vac Transformer		Flexi-Pop only
120V	<i>ELECTRICAL PARTS MOUNTED TO BOTTOM OF MOTOR PLATE (INSIDE CABINET)</i>	240V	
41979	175 WATT HEAT LAMP	47138	
47364	CIRCUIT BREAKER	48659	
48495	SWITCH BOX – OIL DISPENSE BUTTON & MASTER (LABEL IS 48496)	48495	Added Oil Dispense Light Jan 2001
48634	FLEXI POP SWITCH BOX – OIL DISPENSE BUTTON PLUS & MASTER&LIGHTS (LABEL IS 48693)	48634	Flexi-Pop only
48634	SALT/SWEET SWITCH BOX – OIL DISPENSE BUTTON PLUS SALT SWEET SWITCH (LABEL IS 48635)	48634	Salt/Sweet Option only
48615	3 POSITION ROCKER SWITCH FOR SALT/SWEET OPTION	48634	Salt/Sweet Option only
48543	SWITCH BOX – (4) ROCKER SWITCH + (1) YELLOW “DUMP” LIGHT (LABEL IS 48542)	48543	WITHOUT LIGHT 48492/48493 (NOT INTERCHANGABLE)
48700	FLEXI POP SWITCH BOX – (LABEL IS 48701)	48700	Flexi-Pop only
48702	INDICATOR LIGHTS FOR FLEXI POP		Flexi-Pop only
41031	OIL PUMP SWITCH - RED MOMENTARY	41031	
42798	LIGHTED ROCKER SWITCH	42798	
48545	T2 LAMP FOR YELLOW DUMP LIGHT	48545	ADDED TO POP-O-GOLD JAN 2001
48546	T2 SOCKET BASE FOR YELLOW LIGHT	48546	
48547	YELLOW LENS CAP	48547	
48660	OIL DISPENSE LIGHT - GREEN	48660EX	ADDED JAN 2001
39410	3 POSITION ROCKER SWITCH		Flexi-Pop only
Part Number	Description	Part Number	Comments

120V	POP-O-GOLD KETTLE	240V	
2027E	COMP. KETTLE INCLUDING LID/AGITATOR ASSY	2027EEX	
41548E	COMP. KETTLE LESS LID/AGITATOR ASSY	41548EEX	
47976	CROSS ARM HOLD DOWN KNOB – NO PIN	47976	
47977	CROSS ARM HOLD DOWN KNOB – WITH PIN	47977	
47999	THREADED BLOCKS FOR HOLD DOWN KNOBS	47999	
41775	LID/AGITATOR ASSY (COMPONENTS LISTED BELOW)	41775	
41776	CROSS BAR ASSEMBLY WITH OIL FUNNEL – OIL FUNNEL ALONE IS 47689	41776	
41935	FRONT LID	41935	
41937	REAR LID	41937	
41940	AGITATOR WELD ASSEMBLY	41940	
41730	1/8" X 1/2" WOODRUFF KEY FOR SPUR GEAR	41730	
12611	BUTTON HEAD SCREW ON TOP OF AGITATOR SHAFT – HAS LEFT HAND THREADS	12611	SCREW WITH RH THREADS IS 47677
47326	SET COLLAR (SAME ABOVE AND BELOW LID)	47326	
41742	#10 SET SCREW FOR SET COLLAR	41742	
41400	NEEDLE BEARING	41400	ALLOW .05" VERTICAL PLAY FOR BEARING
41380	SPUR GEAR	41380	
	KETTLE MECHANICAL PARTS		
41528	KETTLE SHELL	41528	
41533	KETTLE	41533	
40965	JUNCTION BOX GASKET - LID TO BOX	40965	
40963	JUNCTION BOX GASKET - BOX TO KETTLE	40963	
41534	BUFFER PLATE BETWEEN ELEMENTS & KETTLE	41534	
41597	GASKET SHELL TO KETTLE	41597	
61108	THERMOSTAT PLATE	61108	
46311	1/4"-20 SERRATED LOCK NUT	46311	ELEMENT CLAMPS
41491	HEAT ELEMENT CLAMP (8)	41491	PLACE LEGS AGAINST ELEMENTS
41139	PLASTIC DUMP HANDLE	41139	
Part Number	Description	Part Number	Comments
120V	KETTLE ELECTRICAL COMPONENTS	240V	

48290	KETTLE LEAD ASSEMBLY – COMPONENTS LISTED BELOW	48290	
41253NM	CONDUIT BUSHING – SLIPS IN BOTH ENDS OF FLEX CONDUIT	41253NM	
48575	WIRE ASSEMBLY	48575	
48576	THERMOCOUPLE WIRE ASSEMBLY	48576	
82252-24	FLEX CONDUIT	82252-24	
82262	BRASS CONDUIT SHIM – USED AT JUNCTION BOX END	82262	
47953	KETTLE PLUG	47953	
47090	1050 WATT HEAT ELEMENT - INNER RING	47671	
82231	1800 WATT HEAT ELEMENT - MIDDLE RING	41124	
41536	1000 WATT HEAT ELEMENT - OUTER TUBULAR	41538	
48244	THERMOCOUPLE WIRE ASSEMBLY	48244	
82219	HIGH LIMIT THERMOSTAT (2)	82219	
41129	CERAMIC TERMINAL BLOCK	41129	
61072	WHITE - #12GA-MGT- 2 ¾" LONG – RING TERMINALS ON BOTH ENDS	61072	
61073	WHITE - #12GA-MGT- 8 ¾" LONG – RING TERMINALS ON BOTH ENDS	61073	
61074	WHITE - #12GA-MGT- 7 ¼" LONG – RING TERMINALS ON BOTH ENDS	61074	
61075	RED - #12GA-MGT- 2 7/8" LONG – RING TERMINALS ON BOTH ENDS	61075	
61076	GREEN - #12GA-MGT- 8" LONG – RING TERMINALS ON BOTH ENDS	61076	
61077	BLACK - #12GA-MGT- 2 ½" LONG – RING TERMINALS ON BOTH ENDS	61077	
61078	BLACK - #12GA-MGT- 3 ½" LONG – RING TERMINALS ON BOTH ENDS	61078	
41748	RED - #12GA-MGT- 7 ¼" LONG – RING TERMINALS ON BOTH ENDS	41748	
41769	FRONT OR REAR HANGER ARM	41769	
41618	CLEAN-IN-PLACE LATCH (KNOB IS 12319)	41618	
86009	SHOCK ABSORBER SPRING	86009	
41833	SHOCK ABSORBER PIN (SET SCREW IS 41994)	41833	
Part Number	Description	Comments	
	BASE PARTS		

37513	SWIVEL CASTER	
37514	LOCKING SWIVEL CASTER	
41349	MALE HINGE FOR LEFT DOOR OF BASE	
41350	MALE HINGE FOR RIGHT DOOR OF BASE	
41354	FEMALE HINGE FOR RIGHT DOOR OF BASE	MOUNTS ON DOOR
41355	FEMALE HINGE FOR LEFT DOOR OF BASE	MOUNTS ON DOOR
41689	GRAY CORN BIN	
41515	CORN BIN LID – STAINLESS STEEL	
46511	RIGHT DRAWER SLIDE – BOLTS TO BASE ANGLE	NON-MOVING
46512	LEFT DRAWER SLIDE – BOLTS TO BASE ANGLE	NON-MOVING
41661	CORN BIN RETAINER WITH RIGHT AND LEFT HAND DRAWER SLIDES	MOVING
82698	FLUSH PLASTIC DOOR HANDLES	
67512	DOOR MAGNET (USES 12750 SCREW AND 12386 #4-40 HARDWARE)	HOLDS DOOR CLOSED
	CABINET PARTS	
61129	PLEXIGLASS POPPER DOORS	
41349	MALE HINGE FOR LEFT DOOR OF POPPER	MOUNTS TO CORNER POST
41350	MALE HINGE FOR RIGHT DOOR OF POPPER	MOUNTS TO CORNER POST
41351	FEMALE HINGE FOR RIGHT DOOR OF POPPER	MOUNTS TO DOOR
41352	FEMALE HINGE FOR LEFT DOOR OF POPPER	MOUNTS TO DOOR
40276	“OLD MAID PAN”	
41013	KNOB FOR POPPER DOORS	
61126	PLEXIGLASS PANEL UNDER DOORS 6 ½” TALL	
41282	RUBBER FEET FOR COUNTER MODELS	
41432	GEAR BLOCK - (GUIDES AGITATOR SHAFT)	
41169	FABRIC FILTER	
41250	METAL MESH FILTER	
41540	32 OZ. CORN MEASURE CUP	
41752	FLAVACOL HOLDER	
41162	CLEAR TUBING FOR OIL DELIVERY PUMP – 2 FT.	
41285	CORN PAN (ONE PIECE)	2 PIECE – 48654(RH), 48655(LH)